



# **PROJECT MANUAL**

**FOR**

## **PINEHILL RECYCLING CENTER**

**308 Pinehill Drive  
Mobile, Alabama 36606**

**Project # PW-062-24**

**January 23, 2025**

**Dorsey & Dorsey Engineering, Inc.  
6051 Airport Blvd  
Mobile, AL 36608**

**City of Mobile  
Architectural Engineering Department  
205 Government Plaza  
P.O. Box 1827  
Mobile, Alabama 36633-1827**

**Bid Date: February 12, 2025**

**Set Number: \_\_\_\_\_**

## INDEX TO DOCUMENTS

| SECTION        | DOCUMENT NAME   |
|----------------|---|
| DIVISION 0     | BIDDING AND CONTRACT REQUIREMENTS   |
| Section 00100  | Invitation to Bid   |
| Section 00200  | Instructions to Bidders – AIA Documents A701  |
| Section 00300  | Supplementary Instructions to Bidders   |
| Section 00410  | Bid Form<br>Sales Tax Form C-3A<br>Office of Supplier Diversity Subcontracting and Major Supplier Plan  |
| Section 00500  | Standard form of Agreement Between Owner and Contractor –<br>AIA Documents A101 (with Owner's modifications)  |
| Section 00600  | Bonds, Certificates and Affidavits<br>Performance Bond (Owner's modified form)<br>Labor and Material Payment Bond (Owner's modified form)<br>Application and Certificate for Payment – AIA Document G702 and<br>AIA Document G703 with DBE Utilization Report<br>Certificate of Substantial Completion – AIA Document G704<br>Contractor's Affidavit of Payment of Debts and Claims – AIA Document<br>G706<br>Contractor's Affidavit of Release of Liens – AIA document G706A<br>Consent of Surety to Final Payment – AIA Document G707<br>Request for Taxpayer Identification Number and Certification, W-9 Form,<br>and City of Mobile Vendor Information Form<br>E-Verify Documentation (Sample) |
| Section 00700  | General Conditions of the Contract for Construction –<br>AIA Documents A201 (with Owner's modifications)  |
| DIVISION 1     | GENERAL REQUIREMENTS  |
| Section 01010  | Summary of Work   |
| Section 01210  | Allowances  |
| Section 01220  | Unit Prices   |
| Section 01310  | Project Management & Co-ordination  |
| Section 01320  | Construction Progress Documentation   |
| Section 01330  | Submittal Procedures  |
| Section 01700  | Execution Requirements  |
| Section 01710  | Close out Procedures  |
| Section 01731  | Cutting and Patching  |
| Section 017839 | Project Record Documents  |
| DIVISION 2     | SITWORK   |
| DIVISION 3     | CONCRETE  |
| DIVISION 4     | MASONRY   |
| DIVISION 5     | METALS  |
| DIVISION 6     | WOOD AND PLASTIC  |
| DIVISION 7     | THERMAL AND MOISTURE PROTECTION   |
| DIVISION 8     | DOORS AND WINDOWS   |
| DIVISION 9     | FINISHES  |
| DIVISION 10    | SPECIALTIES   |
| DIVISION 11    | EQUIPMENT   |
| DIVISION 12    | FURNISHINGS   |

Pinehill Recycling Center  
Mobile, Alabama  
PW-062-24

DIVISION 13 SPECIAL CONSTRUCTION

**SECTION 00100  
INVITATION TO BID**

You are invited to submit a sealed bid for construction of the following facility:

PROJECT NAME: Pinehill Recycling Center  
PROJECT LOCATION: 308 Pinehill Drive, Mobile, Alabama 36606  
PROJECT NUMBER: PW-062-24

**1 BID DATE:**

- A. Sealed Bids will be received and clocked in until 2:15 PM local time, Wednesday, the 12th day of February, 2025. Bidders shall insert sealed Bids into a receptacle, marked "City of Mobile Bids", located in the elevator lobby outside the office of the City Clerk Office, 9th Floor South Tower, Government Plaza, 205 Government Street, Mobile, Alabama 36602.
- B. All Bids not clocked in at the City Clerk's Office prior to the time specified, or Bids received after the specified time, will be automatically rejected and returned immediately, unopened.
- C. Bids will be publicly opened and read at 2:30 PM local time, in the Atrium Lobby of Government Plaza.

**2 SPECIFICATIONS AND DRAWINGS:**

- A. Specifications and Drawings are on file and may be examined and obtained from the following location: <https://www.cityofmobile.org/bids/>
- B. Bidders shall use complete sets of Bid Documents in preparing their bid. Neither the Owner nor Architect/Engineer assumes responsibility for errors or misinterpretations resulting from the use of incomplete sets of Bid Documents.
- C. **Addenda will be issued via e-mail to all Pre-Bid Conference attendees.**
- D. **This is a tax exempt project and shall be certified by the requirements of the Alabama Department of Revenue. Bidders shall NOT include sales and use taxes with their bid amounts. Bidders shall complete the Sales Tax Form C-3A and**
- E. Product Substitutions must be pre-approved before the bid (see Section 01400 for requirements).

**3 BID SURETY: Required on Bids \$50,000.00 or more**

- A. A Cashier's Check drawn on a bank registered to do business in the State of Alabama and which is a member of the Federal Deposit Insurance Corporation, or a Bid Bond payable to Owner, City of Mobile, in the amount of 5% of the Base Bid, but in no event more than \$10,000.00 is required to accompany Bid.
- B. Bid Bond must be issued by a Surety licensed to do business in the State of Alabama. Bidder shall require the attorney in fact who executes the required bonds on behalf of the surety to affix to the bond a certified and current copy of the power of attorney.
- C. No Bid may be modified, withdrawn, or canceled for a period of sixty (60) days after the time designated above for receipt of bids.
- D. The City of Mobile will have sixty (60) days from the bid opening date to award contract.



4 SURETY QUALIFICATIONS:

- A. A Surety authorized to do business in the State of Alabama must issue Bonds.
- B. If the Base Bid is \$50,000 or more, the Surety must have a minimum rating of A/Class VI as reported by the latest issue of Best Key Rating Guide Property-Casualty published by Alfred M. Best Company, Inc.

5 IRREGULARITIES AND REJECTION:

- A. The City of Mobile reserves the right to waive irregularities in the Bid and in Bidding, and to reject any or all Bids.

6 BIDDER QUALIFICATIONS:

- A. Bids for Work costing \$50,000 or more must be licensed pursuant to current Alabama law and of classifications compliant with the State of Alabama Licensing Board for General Contractors. Note that if the contract amount is \$10,000 or greater, both a Performance Bond and a Labor and Material Payment Bond shall be required. **Before Bidding, Contractor shall verify their license classification of their General Contractors license with the State of Alabama Licensing Board for General Contractors to verify classification is acceptable to perform 51% of the Scope of Work.**
- B. In case of a joint venture of two or more Contractors, the amount for the bid shall be within the maximum bid limitations as set by the State of Alabama Licensing Board for General Contractors of at least one of the partners to the joint venture.

7 NON-RESIDENT CONTRACTORS:

- A. Except for contracts funded in whole or part with funds received from a federal agency, preference shall be given to resident Contractors on the same basis as the nonresident Contractor's state awards contracts to Alabama Contractors bidding in similar circumstances.
- B. Nonresident Bidders shall, prior to submitting a bid, be registered with the Alabama Secretary of State and the Alabama Department of Revenue. Provide the Secretary of State Business "Entity ID Number" on the Bid Form in the space provided.

8 PRE-BID CONFERENCE:

- A. A Pre-Bid Conference shall be held on January 30, 2025, **at the recycling center located at, 308 Pinehill Drive**, at 10:00 AM local time. The conference will include a walkthrough of the site location. A representative of the Bidder is encouraged to be present at the meeting. However, if no representative can be present in person, the Bidder shall contact the Project Manager at 251-214-1488, at least 24 hours prior to the meeting, in order to coordinate attendance of the meeting by conference call. Bidders are encouraged to participate in the Pre-Bid Conference, visit the site prior to submitting a Bid and include all costs associated with the project in their Bids.
- B. Minutes of this conference will be made as an Addendum for the project.

9 BID SUBMITTAL:

- A. Bids must be submitted on copies of the Bid Forms furnished in the bidding documents.
- B. Bid, with Bid Security, Sales Tax Form C-3A, City of Mobile Subcontracting and Major Supplier Plan and other supporting data specified, shall be contained in a sealed,

opaque envelope, approximately 9x12 inches or larger and be marked on the outside with the words "**SEALED BID FOR PINEHILL RECYCLING CENTER - PROJECT NUMBER: PW-064-24**".

- C. The Bid envelope shall be clearly addressed to the Owner as indicated on the Bid Form and include the bid date, the name, address and State License number and classification of the Bidder issued by the State of Alabama Licensing Board for General Contractors.
- D. All Bids of \$50,000 or more must include the bidder's State of Alabama General Contractor's License information written on the outside of the bid envelope. Any bid submitted without such license information may be rejected and returned to the bidder unopened.
- E. In addition, in large letters on both front and back of envelope, write the following: **DO NOT OPEN UNTIL TWO-THIRTY PM, FEBRUARY 12, 2025.**
- F. For a bid to be valid it shall be delivered at designated location prior to time and date for receipt of Bids indicated in INVITATION TO BID, or prior to any extension thereof issued to Bidders. After that time no Bid will be received or withdrawn.
- G. When sent by mail, preferably special delivery, express service, or registered mail, the sealed Bid, marked as indicated above, shall be enclosed in another envelope for mailing such that the exterior mailing container or envelope may be opened without revealing the contents of the Bid. It is the Contractors responsibility to assure delivery of the bid to the City Clerk's Office prior the time and date established.

#### 10 EQUAL OPPORTUNITY:

- A. The City of Mobile, Alabama is an Equal Opportunity Employer and requires that all Contractors comply with the Equal Employment Opportunity laws and the provisions of the Bid Documents in this regard.
- B. The City of Mobile also encourages and supports the utilization of Minority Business Enterprises on these and all other publicly solicited Bids, and shall be in compliance with the City of Mobile's Minority Utilization Plan as adopted by the City Council.
- C. Contractor shall provide an appropriately completed copy of the "City of Mobile Subcontracting and Major Supplier Plan" in the envelope with their Bid Form. Form shall document DBE Subcontractors participating in the project and, should the total % of DBE participation not meet the 15% minimum, all efforts to obtain DBE Subcontractors shall be documented on or attached to the DBE Form when submitted. During construction, contractors are required to submit a "DBE Utilization Report" with every Pay Application.
- D. Contractors should contact the City of Mobile, Supplier Diversity Manager for assistance with DBE Subcontractor information and any questions regarding the DBE Compliance Forms. Contact Archnique Kidd at 251-208-7967.
- E. A Directory of DBE Vendors can be found at the following location:  
<https://workwith.cityofmobile.org/>

#### 11 ADDITIONAL BIDDING PROCEDURES:

- A. Refer to the complete information in the Bid Documents prior to submitting a bid. Additional Bidding Procedure information is contained therein, particularly in the specification Section 00200 "Instructions to Bidders - AIA Document A701" and in the specification Section 00300 "Supplementary Instructions to Bidders".

#### 12 STATE OF ALABAMA IMMIGRATION ACT

"The State of Alabama, under the Beason-Hammon Alabama Taxpayer and Citizen Protection Act, Act No. 2011-535, Alabama Code Section 31-13-1, et. Seq., requires:

- A. That the Contractor shall be enrolled in the E-Verify Program, shall participate in that Program during the performance of the contract, and shall verify the immigration status of every employee who is required to be verified, according to the applicable federal rules and regulations; and
- B. That it will attach to the contract the company's documentation of enrollment in E-Verify.
- C. The subcontractor must also enroll in the E-Verify Program prior to performing any work on the contract and shall attach to its sworn affidavit documentation establishing that the subcontractor is enrolled in the E-Verify Program.

#### 13 PUBLIC CONTRACTS WITH ENTITIES ENGAGING IN CERTAIN BOYCOTT ACTIVITIES

- A. By signing this contract, Contractor further represents and agrees that it is not currently engaged in, nor will it engage in, any boycott of a person or entity based in or doing business with a jurisdiction with which the State of Alabama can enjoy open trade.

#### 14 FEDERAL CONDITIONS

- B. Job site postings, including the Notice to All Employees working on Federal or Federally Financed Construction Projects and the EEO (Equal Employment Opportunity) poster, will be required to be maintained and shall be in a location accessible to all employees.
- C. Employee interviews for Davis-Bacon wage compliance may be conducted with the assistance of the Project Manager, as coordinated with the Contractor. Certified Payrolls are required. Contractors may become more familiar with these procedures by viewing "A Contractor's Guide to Prevailing Wage Requirements for Federally-Assisted Construction Projects", on-line at <http://portal.hud.gov/hudportal/documents/huddoc?id=DOC12590.pdf>

END OF SECTION 00100

**SECTION 00200**  
**INSTRUCTIONS TO BIDDERS**

**PART 1 GENERAL**

- A. This section includes the INSTRUCTIONS TO BIDDERS, AIA Document A701 to be utilized with the Owner's most recent modifications and which shall be used in conjunction with the entire Bid Documents and Section 00300 SUPPLEMENTARY INSTRUCTIONS TO BIDDERS for this project.



# AIA® Document A701® – 2018

## Instructions to Bidders

for the following Project:  
*(Name, location, and detailed description)*

Pinehill Recycling Center  
308 Pinehill Drive  
Mobile, Alabama 36606  
PW-062-24

**THE OWNER:**  
*(Name, legal status, address, and other information)*

City of Mobile  
PO Box 1827  
Mobile, Alabama 36633-1827

**THE ARCHITECT:**  
*(Name, legal status, address, and other information)*

Dorsey & Dorsey Engineering, Inc.  
6051 Airport Blvd  
Mobile, AL 36608

### TABLE OF ARTICLES

- 1      **DEFINITIONS**
- 2      **BIDDER’S REPRESENTATIONS**
- 3      **BIDDING DOCUMENTS**
- 4      **BIDDING PROCEDURES**
- 5      **CONSIDERATION OF BIDS**
- 6      **POST-BID INFORMATION**
- 7      **PERFORMANCE BOND AND PAYMENT BOND**
- 8      **FORM OF AGREEMENT BETWEEN OWNER AND CONTRACTOR**
- 9      **NONDISCRIMINATION**
- 10     **USE OF DOMESTIC PRODUCTS**
- 11     **PREFERENCE TO RESIDENT CONTRACTORS**
- 12     **PRE-BID REQUIREMENTS**
- 13     **POST-BID REQUIREMENTS**

### ADDITIONS AND DELETIONS:

The author of this document has added information needed for its completion. The author may also have revised the text of the original AIA standard form. An *Additions and Deletions Report* that notes added information as well as revisions to the standard form text is available from the author and should be reviewed. A vertical line in the left margin of this document indicates where the author has added necessary information and where the author has added to or deleted from the original AIA text.

This document has important legal consequences. Consultation with an attorney is encouraged with respect to its completion or modification.

FEDERAL, STATE, AND LOCAL LAWS MAY IMPOSE REQUIREMENTS ON PUBLIC PROCUREMENT CONTRACTS. CONSULT LOCAL AUTHORITIES OR AN ATTORNEY TO VERIFY REQUIREMENTS APPLICABLE TO THIS PROCUREMENT BEFORE COMPLETING THIS FORM.

It is intended that AIA Document G612™–2017, Owner’s Instructions to the Architect, Parts A and B will be completed prior to using this document.

## ARTICLE 1 DEFINITIONS

§ 1.1 Bidding Documents include the Bidding Requirements and the Proposed Contract Documents. The Bidding Requirements consist of the advertisement or invitation to bid, Instructions to Bidders, supplementary instructions to bidders, the bid form, and any other bidding forms. The Proposed Contract Documents consist of the unexecuted form of Agreement between the Owner and Contractor and that Agreement's Exhibits, Conditions of the Contract (General, Supplementary and other Conditions), Drawings, Specifications, all Addenda, and all other documents enumerated in Article 8 of these Instructions.

§ 1.2 Definitions set forth in the General Conditions of the Contract for Construction, or in other Proposed Contract Documents apply to the Bidding Documents.

§ 1.3 Addenda are written or graphic instruments issued by the Architect, which, by additions, deletions, clarifications, or corrections, modify or interpret the Bidding Documents.

§ 1.4 A Bid is a complete and properly executed proposal to do the Work for the sums stipulated therein, submitted in accordance with the Bidding Documents.

§ 1.5 The Base Bid is the sum stated in the Bid for which the Bidder offers to perform the Work described in the Bidding Documents, to which Work may be added or deleted by sums stated in Alternate Bids.

§ 1.6 An Alternate Bid (or Alternate) is an amount stated in the Bid to be added to or deducted from, or that does not change, the Base Bid if the corresponding change in the Work, as described in the Bidding Documents, is accepted.

§ 1.7 A Unit Price is an amount stated in the Bid as a price per unit of measurement for materials, equipment, or services, or a portion of the Work, as described in the Bidding Documents.

§ 1.8 A Bidder is a person or entity who submits a Bid and who meets the requirements set forth in the Bidding Documents. A Bidder must be licensed by the State Licensing Board for General Contractors if the amount for the Contract exceeds the amount established by said Board.

§ 1.9 A Sub-bidder is a person or entity who submits a bid to a Bidder for materials, equipment, or labor for a portion of the Work. A Sub-bidder performing Work must be licensed by the State Licensing Board for General Contractors if the Sub-bidders' contract amount exceeds that established by said Board.

1.10 A non-resident Bidder or Sub-bidder is one who

- a. Is neither organized nor existing under the laws of the State of Alabama
- b. nor maintains its principal place of business in the State of Alabama.

A non-resident contractor who has maintained a permanent branch office within the State of Alabama for at least five (5) continuous years shall not thereafter be deemed to be a non-resident contractor so long as such contractor continues to maintain a branch office within Alabama.

## ARTICLE 2 BIDDER'S REPRESENTATIONS

§ 2.1 By submitting a Bid, the Bidder represents that:

- .1 the Bidder has read and understands the Bidding Documents;
- .2 the Bidder understands how the Bidding Documents relate to other portions of the Project, if any, being bid concurrently or presently under construction;
- .3 the Bid complies with the Bidding Documents;
- .4 the Bidder has visited the site, become familiar with local conditions under which the Work is to be performed, and has correlated the Bidder's observations with the requirements of the Proposed Contract Documents;
- .5 the Bid is based upon the materials, equipment, and systems required by the Bidding Documents without exception; and
- .6 the Bidder has read and understands the provisions for liquidated damages, if any, set forth in the form of Agreement between the Owner and Contractor.

§ 2.2 The Bidder is licensed by the State Licensing Board for General Contractors and the amount Bid does not exceed the Bid Limit stipulated in the Bidder's License and by the City of Mobile.

§ 2.3 Each and every Contractor belonging to or comprising a part of any entity that is bidding as a joint venture or association involving two or more contractors is licensed by the State Licensing Board for General Contractors and that the amount Bid does not exceed the Bid limit stipulated in at least one of their licenses.

§ 2.4 Any non-resident Bidder is authorized by the Secretary of State of Alabama and is registered with Alabama Department of Revenue to transact business in Alabama.

§ 2.5 Joint Ventures or Associations of Contractors, whether the same are Bidders or Subcontractors of Bidders, will remain in existence until all insurance and warranty requirements for the Project have been fulfilled.

### **ARTICLE 3 BIDDING DOCUMENTS**

#### **§ 3.1 Distribution**

§ 3.1.1 Bidders shall obtain complete Bidding Documents, as indicated below, from the issuing office designated in the advertisement or invitation to bid, for the deposit sum, if any, stated therein.

*(Paragraphs deleted)*

§ 3.1.2 Any required deposit shall be refunded to Bidders who submit a bona fide Bid and return the paper Bidding Documents in good condition within ten days after receipt of Bids. The cost to replace missing or damaged paper documents will be deducted from the deposit. A Bidder receiving a Contract award may retain the paper Bidding Documents, and the Bidder's deposit will be refunded.

§ 3.1.3 Bidding Documents will not be issued directly to Sub-bidders unless specifically offered in the advertisement or invitation to bid, or in supplementary instructions to bidders.

§ 3.1.4 Bidders shall use complete Bidding Documents in preparing Bids. Neither the Owner nor Architect assumes responsibility for errors or misinterpretations resulting from the use of incomplete Bidding Documents.

§ 3.1.5 The Bidding Documents will be available for the sole purpose of obtaining Bids on the Work. No license or grant of use is conferred by distribution of the Bidding Documents.

#### **§ 3.2 Modification or Interpretation of Bidding Documents**

§ 3.2.1 The Bidder shall carefully study the Bidding Documents, shall examine the site and local conditions, and shall notify the Architect of errors, inconsistencies, or ambiguities discovered and request clarification or interpretation pursuant to Section 3.2.2.

§ 3.2.2 Requests for clarification or interpretation of the Bidding Documents shall be submitted by the Bidder in writing and shall be received by the Architect at least five (5) calendar days prior to the date for receipt of Bids.

*(Paragraphs deleted)*

§ 3.2.3 Modifications and interpretations of the Bidding Documents shall be made by Addendum. Modifications and interpretations of the Bidding Documents made in any other manner shall not be binding, and Bidders shall not rely upon them.

§ 3.2.4 The Contract Drawings and Specifications are intended to cooperate and agree, but should conflicts or difference be found to exist between the requirements within either and clarification has not been obtained in accordance with the above procedure prior to Bidding, then the most costly and/or restrictive interpretation by the decision of the Architectural Engineering Department Director will be final.

#### **§ 3.3 Substitutions**

§ 3.3.1 The materials, products, and equipment described in the Bidding Documents establish a standard of required function, dimension, appearance, and quality to be met by any proposed substitution.

### **§ 3.3.2 Substitution Process**

§ 3.3.2.1 Written requests for substitutions shall be received by the Architect at least fifteen (15) calendar days prior to the date for receipt of Bids. Requests shall be submitted in the same manner as that established for submitting clarifications and interpretations in Section 3.2.2.

§ 3.3.2.2 Bidders shall submit substitution requests on a Substitution Request Form if one is provided in the Bidding Documents.

§ 3.3.2.3 If a Substitution Request Form is not provided, requests shall include (1) the name of the material or equipment specified in the Bidding Documents; (2) the reason for the requested substitution; (3) a complete description of the proposed substitution including the name of the material or equipment proposed as the substitute, performance and test data, and relevant drawings; and (4) any other information necessary for an evaluation. The request shall include a statement setting forth changes in other materials, equipment, or other portions of the Work, including changes in the work of other contracts or the impact on any Project Certifications (such as LEED), that will result from incorporation of the proposed substitution.

§ 3.3.3 The burden of proof of the merit of the proposed substitution is upon the proposer. The Architect's decision of approval or disapproval of a proposed substitution shall be final.

§ 3.3.4 If the Architect approves a proposed substitution prior to receipt of Bids, such approval shall be set forth in an Addendum. Approvals made in any other manner shall not be binding, and Bidders shall not rely upon them.

§ 3.3.5 No substitutions will be considered after the Contract award unless specifically provided for in the Contract Documents.

§ 3.3.6 See Division One Section "Substitution Procedures", if included in Specification.

### **§ 3.4 Addenda**

§ 3.4.1 Addenda will be transmitted to Bidders known by the issuing office to have received complete Bidding Documents.

*(Paragraphs deleted)*

§ 3.4.2 Addenda will be available where Bidding Documents are on file.

§ 3.4.3 Addenda will be issued no later than two (2) days prior to the date for receipt of Bids, except an Addendum withdrawing the request for Bids or one which includes postponement of the date for receipt of Bids.

§ 3.4.4 Prior to submitting a Bid, each Bidder shall ascertain that the Bidder has received all Addenda issued, and the Bidder shall acknowledge their receipt in the Bid.

## **ARTICLE 4 BIDDING PROCEDURES**

### **§ 4.1 Preparation of Bids**

§ 4.1.1 Bids shall be submitted on the forms included with or identified in the Bidding Documents. No bid will be considered unless made out and submitted on a copy of the Bid Form, Section 00410. Additional Bid Forms will be furnished to prospective Bidders upon request.

§ 4.1.2 All blanks on the bid form shall be legibly executed. Paper bid forms shall be executed in a non-erasable medium.

§ 4.1.3 Sums shall be expressed in both words and numbers, unless noted otherwise on the bid form. In case of discrepancy, the amount entered in words shall govern.

§ 4.1.4 Edits to entries made on paper bid forms must be initialed by the signer of the Bid.

§ 4.1.5 All requested Alternates shall be bid. If no change in the Base Bid is required, enter "No Change" or as required by the bid form.

Unit Prices: Supply requested Unit Prices where shown on the Bid Form, Such Unit Prices shall be used to adjust the Contract Amount where the quantities shown on the Drawings and/or Specifications do not reflect amounts required for



completion of the work. Where Completion of the Work requires quantities in excess of those shown on the drawings and specifications, unit prices shall be used to compute an extra payment to the Contractor. Where completion of work required quantities less than those on the Drawings and/or specifications, unit prices shall be used to compute a credit to the Owner.

Contingency Allowance: As shown on the Bid Form, Contractor shall add the amount of the contingency allowance to the Base Bid to derive the Total Bid. The contingency allowance shall cover cost of material, labor, overhead, profit and other expenses for complete installation of items of additional work as required for a complete functional project. The contingency allowance shall be used to fund unforeseen conditions not covered in the construction documents and shall be subject to the provisions of change orders. Upon the completion of work any unused portion of the contingency allowance shall be credited to the Owner by change order.

§ 4.1.6 Where two or more Bids for designated portions of the Work have been requested, the Bidder may, without forfeiture of the bid security, state the Bidder's refusal to accept award of less than the combination of Bids stipulated by the Bidder. The Bidder shall neither make additional stipulations on the bid form nor qualify the Bid in any other manner.

§ 4.1.7 Each copy of the Bid shall state the legal name and legal status of the Bidder. As part of the documentation submitted with the Bid, the Bidder shall provide evidence of its legal authority to perform the Work in the jurisdiction where the Project is located. Each copy of the Bid shall be signed by the person or persons legally authorized to bind the Bidder to a contract. A Bid by a corporation shall further name the state of incorporation and have the corporate seal affixed. A Bid submitted by an agent shall have a current power of attorney attached, certifying the agent's authority to bind the Bidder.

§ 4.1.8 A Bidder shall incur all costs associated with the preparation of its Bid.

#### § 4.2 Bid Security

§ 4.2.1 Each Bid shall be accompanied by the following bid security if so required in the Bidding Documents:  
*(Insert the form and amount of bid security.)*

The Bidder shall provide a Bid Security in the form of a cashier's check drawn on a bank registered to do business in the State of Alabama and which is a member of the Federal Deposit Insurance Corporation, or a Bid Bond. Bid Security is required for bids exceeding \$10,000.00. Bid Security shall be in the amount of 5% of the TOTAL BID, but in no event more than \$10,000.00.

§ 4.2.2 The Bidder pledges to enter into a Contract with the Owner on the terms stated in the Bid and shall, if required, furnish bonds covering the faithful performance of the Contract and payment of all obligations arising thereunder. Should the Bidder refuse to enter into such Contract or fail to furnish such bonds if required, the amount of the bid security shall be forfeited to the Owner as liquidated damages, not as a penalty.

§ 4.2.3 If a surety bond is required as bid security, it shall be written on AIA Document A310™, Bid Bond, unless otherwise provided in the Bidding Documents. The attorney-in-fact who executes the bond on behalf of the surety shall affix to the bond a certified and current copy of an acceptable power of attorney. The Bidder shall provide surety bonds from a company or companies lawfully authorized to issue surety bonds in the jurisdiction where the Project is located.

§ 4.2.4 The Owner will have the right to retain the bid security of Bidders to whom an award is being considered until (a) the Contract has been executed and bonds, if required, have been furnished; (b) the specified time has elapsed so that Bids may be withdrawn; or (c) all Bids have been rejected.

§ 4.2.5 Bonds must be issued by a Surety authorized to do business in the State of Alabama. A Performance Bond and a Labor and Material Payment Bond are required for projects exceeding \$10,000.00. If the project cost is \$50,000.00 or more, the Surety must have a minimum rating of A/Class VI as reported by the latest issue of Best's Key Rating Guide Property-Casualty published by Alfred M. Best Company, Inc.

#### § 4.3 Submission of Bids

§ 4.3.1 A Bidder shall submit its Bid as indicated below:

*(Indicate how, such as by website, host site/platform, paper copy, or other method Bidders shall submit their Bid.)*

Submission of Bid shall be as stated in Section 00100, Invitation to Bid, Paragraph 9, titled "Bid Submittal".

*(Paragraph deleted)*

§ 4.3.3 Bids shall be submitted by the date and time and at the place indicated in the invitation to bid. Bids submitted after the date and time for receipt of Bids, or at an incorrect place, will not be accepted and will be returned unopened.

§ 4.3.4 The Bidder shall assume full responsibility for timely delivery at the location designated for receipt of Bids.

§ 4.3.5 A Bid submitted by any method other than as provided in this Section 4.3 will not be accepted.

#### § 4.4 Modification or Withdrawal of Bid

§ 4.4.1 Prior to the date and time designated for receipt of Bids, a Bidder may submit a new Bid to replace a Bid previously submitted, or withdraw its Bid entirely, by notice to the party designated to receive the Bids. Such notice shall be received and duly recorded by the receiving party on or before the date and time set for receipt of Bids. The receiving party shall verify that replaced or withdrawn Bids are removed from the other submitted Bids and not considered. Notice of submission of a replacement Bid or withdrawal of a Bid shall be worded so as not to reveal the amount of the original Bid.

§ 4.4.2 Withdrawn Bids may be resubmitted up to the date and time designated for the receipt of Bids in the same format as that established in Section 4.3, provided they fully conform with these Instructions to Bidders. Bid security, if required, shall be in an amount sufficient for the Bid as resubmitted.

*(Paragraphs deleted)*

### ARTICLE 5 CONSIDERATION OF BIDS

#### § 5.1 Opening of Bids

If stipulated in an advertisement or invitation to bid, or when otherwise required by law, Bids properly identified and received within the specified time limits will be publicly opened and read aloud. A summary of the Bids may be made available to Bidders.

#### § 5.2 Rejection of Bids

Unless otherwise prohibited by law, the Owner shall have the right to reject any or all Bids.

#### § 5.3 Acceptance of Bid (Award)

§ 5.3.1 It is the intent of the Owner to award a Contract to the lowest responsive and responsible Bidder, provided the Bid has been submitted in accordance with the requirements of the Bidding Documents and does not exceed the funds available. Unless otherwise prohibited by law, the Owner shall have the right to waive informalities and irregularities in a Bid received and to accept the Bid which, in the Owner's judgment, is in the Owner's best interests.

§ 5.3.2 The Owner shall accept Alternates in the order listed on the Bid Form to determine the lowest responsive and responsible Bidder on the basis of the sum of the Base Bid and Alternates accepted.

### ARTICLE 6 POST-BID INFORMATION

#### § 6.1 Contractor's Qualification Statement

Bidders to whom award of a Contract is under consideration shall submit to the Architect, upon request and within the timeframe specified by the Architect, a properly executed AIA Document A305™, Contractor's Qualification Statement, unless such a Statement has been previously required and submitted for this Bid.

*(Paragraphs deleted)*

#### § 6.3 Submittals

§ 6.3.1 After notification of selection for the award of the Contract, the Bidder shall, within three (3) calendar days or as stipulated in the Bidding Documents, submit in writing to the Owner through the Architect:

- .1 a designation of the Work to be performed with the Bidder's own forces;
- .2 names of the principal products and systems proposed for the Work and the manufacturers and suppliers of each; and
- .3 names of persons or entities (including those who are to furnish materials or equipment fabricated to a special design) proposed for the principal portions of the Work.

- .4 The name of the Project Superintendent and Project Manager together with the resume of qualifications of each;
- .5 Nonresident Contractor shall submit a letter from an attorney as required by Subparagraph 11.1.2 below and;
- .6 Engineering Firm or Testing Laboratory for testing as specified.

§ 6.3.2 The Bidder will be required to establish to the satisfaction of the Architect and Owner the reliability and responsibility of the persons or entities proposed to furnish and perform the Work described in the Bidding Documents.

§ 6.3.3 Prior to the execution of the Contract, the Architect will notify the Bidder if either the Owner or Architect, after due investigation, has reasonable objection to a person or entity proposed by the Bidder. If the Owner or Architect has reasonable objection to a proposed person or entity, the Bidder may, at the Bidder's option, withdraw the Bid or submit an acceptable substitute person or entity. The Bidder may also submit any required adjustment in the Base Bid or Alternate Bid to account for the difference in cost occasioned by such substitution. The Owner may accept the adjusted bid price or disqualify the Bidder. In the event of either withdrawal or disqualification, bid security will not be forfeited.

§ 6.3.4 Persons and entities proposed by the Bidder and to whom the Owner and Architect have made no reasonable objection must be used on the Work for which they were proposed and shall not be changed except with the written consent of the Owner and Architect.

§ 6.3.5 The Contractor shall, within ten (10) calendar days of receiving Contract Forms for signature, furnish to the Owner the following items, along with the signed contract, or the Bid Security will be forfeited automatically without further delay:

- .1 A Signed Construction Contract;
- .2 Performance Bond and Labor and Material Payment Bond (originals) on all Bids over \$10,000.00;
- .3 Certificate of Insurance and copy of Builder's Risk Policy (original), as identified in the specifications;
- .4 Schedule of Values; and
- .5 Federal Immigration Law Compliance: E-Verify enrollment documentation.

§ 6.3.6 The Bid Check or Bond of the three (3) lowest Bidders will not be returned until after the Construction Contract is executed.

## **ARTICLE 7 PERFORMANCE BOND AND PAYMENT BOND**

### **§ 7.1 Bond Requirements**

§ 7.1.1 If stipulated in the Bidding Documents, the Bidder shall furnish bonds covering the faithful performance of the Contract and payment of all obligations arising thereunder.

§ 7.1.2 If the furnishing of such bonds is stipulated in the Bidding Documents, the cost shall be included in the Bid. If the furnishing of such bonds is required after receipt of bids and before execution of the Contract, the cost of such bonds shall be added to the Bid in determining the Contract Sum.

§ 7.1.3 The Bidder shall provide surety bonds from a company or companies lawfully authorized to issue surety bonds in the jurisdiction where the Project is located.

§ 7.1.4 Unless otherwise indicated below, the Penal Sum of the Payment and Performance Bonds shall be the amount of the Contract Sum.

§ 7.1.4 A Surety authorized to do business in the State of Alabama shall issue Performance Bond and Labor and Material Payment Bond, as required by the Contract Documents. If the project cost is \$50,000.00 or more, the Surety must have a minimum rating of A/Class VI as reported by the latest issue of Best's Key Rating Guide Property-Casualty, published by Alfred M. Best Company, Inc.

### **§ 7.2 Time of Delivery and Form of Bonds**

§ 7.2.1 The Bidder shall deliver the required bonds to the Owner not later than ten (10) calendar days from receiving the Construction Contract forms for signature.

§ 7.2.2 The bonds shall be written on City's Performance Bond and Labor and Material Payment Bond forms.

§ 7.2.3 The bonds shall be dated on or after the date of the Contract.

§ 7.2.4 The Bidder shall require the attorney-in-fact who executes the required bonds on behalf of the surety to affix to the bond a certified and current copy of the power of attorney.

#### **ARTICLE 8 FORM OF AGREEMENT BETWEEN OWNER AND CONTRACTOR**

Unless otherwise required in the Bidding Documents, the Agreement for the Work will be written on AIA Document A101, Standard Form of Agreement Between Owner and Contractor Where the Basis of Payment Is a Stipulated Sum.

§ 8.1.1 AIA Document A101, Standard Form of Agreement Between Owner and Contractor where the Basis of Payment is a stipulated sum will be edited electronically and include the standard signatures as required by the City of Mobile.

#### **ARTICLE 9 NONDISCRIMINATION**

§9.1.1 Contractor shall comply with all Federal, State and local laws concerning nondiscrimination, including but not limited to City of Mobile Ordinance No. 14-034 which requires, *inter alia*, that all contractors performing work for the City of Mobile not discriminate on the basis of race, creed, color, national origin or disability, require that all subcontractors they engage do the same, and make every reasonable effort to assure that fifteen percent of the work performed under contract be awarded to socially and economically disadvantaged individuals and business entities. Contractor shall provide a completed copy of the City of Mobile Subcontracting and Major Supplier Plan with the Bid Form, for bids of \$250,000.00 or greater.

#### **ARTICLE 10 USE OF DOMESTIC PRODUCTS**

§ 10.1.1 Section 39-3-1 Code of Alabama provides that the Contractor agrees, in the execution of this contract, to use material supplies and products manufactured, mined, processed or otherwise produced in the United States or its territories, if available at reasonable prices, and that breach of this agreement by the Contractor shall result in the assessment of liquidated damages in an amount not less than \$500 nor more than 20 percent of the gross amount of the contract price.

§ 10.1.2 Section 39-3-4, Code of Alabama provides that the Contractor for a municipal construction project, financed by the State of Alabama or any political subdivision thereof, is required to use steel produced within the United States. If the Contractor violates the requirement to use domestic steel, this contract will automatically be revoked and the contractor shall not be entitled to any set-off or recoupment for labor or materials used up to the time of revocation.

#### **ARTICLE 11 PREFERENCE TO RESIDENT CONTRACTORS**

§ 11.1.1 Except for contracts funded in whole or in part with funds received from a federal agency, preference shall be given to Alabama resident contractors, and a nonresident bidder domiciled in a state having laws granting preference to local contractors shall be awarded the contracts only on the same basis as a the nonresident bidder's state awards contracts to Alabama contractors bidding under similar circumstances. In the letting of public contracts in which any state, county or municipal funds are utilized, resident contractors in Alabama, be they corporations, individuals or partnerships, are to be granted preference over nonresidents in awarding of contracts in the same manner and to the same extent as provided by the laws of the state of domicile of the nonresident.

§ 11.1.2 A successful nonresident bidder shall include in his post bid submittals a written opinion of an attorney at law licensed to practice law in such nonresident bidders' state of domicile, as to the preferences, if any or none, granted by the law of that state to its own business entities whose principal places of business are in that state in the letting of any or all public contracts.

#### **ARTICLE 12 PRE-BID REQUIREMENTS**

##### **§ 12.1 STATE OF ALABAMA CONTRACTORS LICENSE**

§ 12.1.1 If the Project total bid amount is \$50,000 or more, a license issued by the State of Alabama Licensing Board for General Contractors is required prior to submitting a bid and the licensed classification and bid limits must cover the type of work in this project. See Invitation to Bid, Section 6 "Bidder Qualifications".

##### **§ 12.2 A NONRESIDENT BIDDER**

§ 12.2.1 Every bidder shall be registered with the Department of Revenue and with the Alabama Secretary of the State

prior to bidding. The Secretary of State's "Business Entity ID" registration number shall be included on the bid form.

**ARTICLE 13 POST-BID REQUIREMENTS**

**§ 13.1 CITY CONTRACTOR'S LICENSE**

**13.1.1** A City of Mobile Contractors License is required and must be current before the Contractor signs the Contract. Contractor must qualify and post \$10,000.00 Surety Bond with the Land Use/Code Administration Department before a Contractors License will be issued by the Revenue Department. Information on the City Contractors License may be obtained by writing or calling:

Land Use/Code Administration  
P. O. Box 1827  
Mobile, Alabama 36633-1827  
Phone: 251.208.7421

Revenue Department  
P. O. Box 1827  
Mobile, Alabama 36633-1827  
251.208.7461

**13.2 E-VERIFY DOCUMENTATION**

**§ 13.2.1** The Contractor agrees that it shall comply with all of the requirements of the State of Alabama Immigration Law (Act. No. 2011-535 as amended by Act. No. 2012-491, Alabama Code (1975) Section 31-13-1, et. Seq., See Section 31-13-9), and the provisions of said Law, including all penalties for violation thereof, are incorporated therein.

**13.3 PUBLIC CONTRACTS WITH ENTITIES ENGAGING IN CERTAIN BOYCOTT ACTIVITIES**

**§ 13.3** The Contractor represents and agrees that it is not currently engaged in, nor will engage in, any boycott of a person or entity based in or doing business with a jurisdiction with which the State of Alabama can enjoy open trade.

*(Table deleted)(Paragraphs deleted)(Paragraphs deleted)*

# Additions and Deletions Report for AIA® Document A701® – 2018

This Additions and Deletions Report, as defined on page 1 of the associated document, reproduces below all text the author has added to the standard form AIA document in order to complete it, as well as any text the author may have added to or deleted from the original AIA text. Added text is shown underlined. Deleted text is indicated with a horizontal line through the original AIA text.

Note: This Additions and Deletions Report is provided for information purposes only and is not incorporated into or constitute any part of the associated AIA document. This Additions and Deletions Report and its associated document were generated simultaneously by AIA software at 14:25:32 ET on 01/30/2025.

## PAGE 1

Pinehill Recycling Center  
308 Pinehill Drive  
Mobile, Alabama 36606  
PW-062-24

...

City of Mobile  
PO Box 1827  
Mobile, Alabama 36633-1827

...

Dorsey & Dorsey Engineering, Inc.  
6051 Airport Blvd  
Mobile, AL 36608

...

**8** ENUMERATION OF THE PROPOSED CONTRACT DOCUMENTS FORM OF AGREEMENT BETWEEN OWNER AND CONTRACTOR

**9** NONDISCRIMINATION

**10** USE OF DOMESTIC PRODUCTS

**11** PREFERENCE TO RESIDENT CONTRACTORS

**12** PRE-BID REQUIREMENTS

**13** POST-BID REQUIREMENTS

## PAGE 2

**§ 1.8** A Bidder is a person or entity who submits a Bid and who meets the requirements set forth in the Bidding Documents. A Bidder must be licensed by the State Licensing Board for General Contractors if the amount for the Contract exceeds the amount established by said Board.

**§ 1.9** A Sub-bidder is a person or entity who submits a bid to a Bidder for materials, equipment, or labor for a portion of the Work. A Sub-bidder performing Work must be licensed by the State Licensing Board for General Contractors if the Sub-bidders' contract amount exceeds that established by said Board.

**1.10** A non-resident Bidder or Sub-bidder is one who

a. Is neither organized nor existing under the laws of the State of Alabama

b. nor maintains its principal place of business in the State of Alabama.

A non-resident contractor who has maintained a permanent branch office within the State of Alabama for at least five (5) continuous years shall not thereafter be deemed to be a non-resident contractor so long as such contractor continues to maintain a branch office within Alabama.

**PAGE 3**

§ 2.2 The Bidder is licensed by the State Licensing Board for General Contractors and the amount Bid does not exceed the Bid Limit stipulated in the Bidder's License and by the City of Mobile.

§ 2.3 Each and every Contractor belonging to or comprising a part of any entity that is bidding as a joint venture or association involving two or more contractors is licensed by the State Licensing Board for General Contractors and that the amount Bid does not exceed the Bid limit stipulated in at least one of their licenses.

§ 2.4 Any non-resident Bidder is authorized by the Secretary of State of Alabama and is registered with Alabama Department of Revenue to transact business in Alabama.

§ 2.5 Joint Ventures or Associations of Contractors, whether the same are Bidders or Subcontractors of Bidders, will remain in existence until all insurance and warranty requirements for the Project have been fulfilled.

...

*(Indicate how, such as by email, website, host site/platform, paper copy, or other method Bidders shall obtain Bidding Documents.)*

...

§ 3.2.2 Requests for clarification or interpretation of the Bidding Documents shall be submitted by the Bidder in writing and shall be received by the Architect at least ~~seven-five (5)~~ calendar days prior to the date for receipt of Bids.  
*(Indicate how, such as by email, website, host site/platform, paper copy, or other method Bidders shall submit requests for clarification and interpretation.)*

...

§ 3.2.4 The Contract Drawings and Specifications are intended to cooperate and agree, but should conflicts or difference be found to exist between the requirements within either and clarification has not been obtained in accordance with the above procedure prior to Bidding, then the most costly and/or restrictive interpretation by the decision of the Architectural Engineering Department Director will be final.

**PAGE 4**

§ 3.3.2.1 Written requests for substitutions shall be received by the Architect at least ~~ten~~ fifteen (15) calendar days prior to the date for receipt of Bids. Requests shall be submitted in the same manner as that established for submitting clarifications and interpretations in Section 3.2.2.

...

§ 3.3.6 See Division One Section "Substitution Procedures", if included in Specification.

...

*(Indicate how, such as by email, website, host site/platform, paper copy, or other method Addenda will be transmitted.)*

...

§ 3.4.3 Addenda will be issued no later than ~~four~~ two (2) days prior to the date for receipt of Bids, except an Addendum withdrawing the request for Bids or one which includes postponement of the date for receipt of Bids.

...

§ 4.1.1 Bids shall be submitted on the forms included with or identified in the Bidding Documents. No bid will be considered unless made out and submitted on a copy of the Bid Form, Section 00410. Additional Bid Forms will be furnished to prospective Bidders upon request.

...

Unit Prices: Supply requested Unit Prices where shown on the Bid Form. Such Unit Prices shall be used to adjust the Contract Amount where the quantities shown on the Drawings and/or Specifications do not reflect amounts required for completion of the work. Where Completion of the Work requires quantities in excess of those shown on the drawings and specifications, unit prices shall be used to compute an extra payment to the Contractor. Where completion of work required quantities less than those on the Drawings and/or specifications, unit prices shall be used to compute a credit to the Owner.

Contingency Allowance: As shown on the Bid Form, Contractor shall add the amount of the contingency allowance to the Base Bid to derive the Total Bid. The contingency allowance shall cover cost of material, labor, overhead, profit and other expenses for complete installation of items of additional work as required for a complete functional project. The contingency allowance shall be used to fund unforeseen conditions not covered in the construction documents and shall be subject to the provisions of change orders. Upon the completion of work any unused portion of the contingency allowance shall be credited to the Owner by change order.

## PAGE 5

§ 4.2.1 Each Bid shall be accompanied by the following bid ~~security~~ security if so required in the Bidding Documents:

...

The Bidder shall provide a Bid Security in the form of a cashier's check drawn on a bank registered to do business in the State of Alabama and which is a member of the Federal Deposit Insurance Corporation, or a Bid Bond. Bid Security is required for bids exceeding \$10,000.00. Bid Security shall be in the amount of 5% of the TOTAL BID, but in no event more than \$10,000.00.

§ 4.2.2 The Bidder pledges to enter into a Contract with the Owner on the terms stated in the Bid and shall, if required, furnish bonds covering the faithful performance of the Contract and payment of all obligations arising thereunder. Should the Bidder refuse to enter into such Contract or fail to furnish such bonds if required, the amount of the bid security shall be forfeited to the Owner as liquidated damages, not as a penalty. ~~In the event the Owner fails to comply with Section 6.2, the amount of the bid security shall not be forfeited to the Owner.~~

...

§ 4.2.4 The Owner will have the right to retain the bid security of Bidders to whom an award is being considered until (a) the Contract has been executed and bonds, if required, have been furnished; (b) the specified time has elapsed so that Bids may be withdrawn; or (c) all Bids have been rejected. ~~However, if no Contract has been awarded or a Bidder~~



has not been notified of the acceptance of its Bid, a Bidder may, beginning days after the opening of Bids, withdraw its Bid and request the return of its bid security.

§ 4.2.5 Bonds must be issued by a Surety authorized to do business in the State of Alabama. A Performance Bond and a Labor and Material Payment Bond are required for projects exceeding \$10,000.00. If the project cost is \$50,000.00 or more, the Surety must have a minimum rating of A/Class VI as reported by the latest issue of Best's Key Rating Guide Property-Casualty published by Alfred M. Best Company, Inc.

**PAGE 6**

Submission of Bid shall be as stated in Section 00100, Invitation to Bid, Paragraph 9, titled "Bid Submittal".

~~§ 4.3.2 Paper copies of the Bid, the bid security, and any other documents required to be submitted with the Bid shall be enclosed in a sealed opaque envelope. The envelope shall be addressed to the party receiving the Bids and shall be identified with the Project name, the Bidder's name and address, and, if applicable, the designated portion of the Work for which the Bid is submitted. If the Bid is sent by mail, the sealed envelope shall be enclosed in a separate mailing envelope with the notation "SEALED BID ENCLOSED" on the face thereof.~~

~~§ 4.3.3 Bids shall be submitted by the date and time and at the place indicated in the invitation to bid. Bids submitted after the date and time for receipt of Bids, or at an incorrect place, will not be ~~accepted~~ accepted and will be returned unopened.~~

...

~~§ 4.4.2 Withdrawn Bids may be resubmitted up to the date and time designated for the receipt of Bids in the same format as that established in Section 4.3, provided they fully conform with these Instructions to Bidders. Bid security security, if required, shall be in an amount sufficient for the Bid as resubmitted.~~

~~§ 4.4.3 After the date and time designated for receipt of Bids, a Bidder who discovers that it made a clerical error in its Bid shall notify the Architect of such error within two days, or pursuant to a timeframe specified by the law of the jurisdiction where the Project is located, requesting withdrawal of its Bid. Upon providing evidence of such error to the reasonable satisfaction of the Architect, the Bid shall be withdrawn and not resubmitted. If a Bid is withdrawn pursuant to this Section 4.4.3, the bid security will be attended to as follows:  
(State the terms and conditions, such as Bid rank, for returning or retaining the bid security.)~~

...

~~§ 5.3.1 It is the intent of the Owner to award a Contract to the lowest responsive and responsible Bidder, provided the Bid has been submitted in accordance with the requirements of the Bidding Documents. Documents and does not exceed the funds available. Unless otherwise prohibited by law, the Owner shall have the right to waive informalities and irregularities in a Bid received and to accept the Bid which, in the Owner's judgment, is in the Owner's best interests.~~

~~§ 5.3.2 Unless otherwise prohibited by law, the Owner shall have the right to accept Alternates in any order or combination, unless otherwise specifically provided in the Bidding Documents, and The Owner shall accept Alternates in the order listed on the Bid Form to determine the lowest responsive and responsible Bidder on the basis of the sum of the Base Bid and Alternates accepted.~~

...

**§ 6.2 Owner's Financial Capability**

~~A Bidder to whom award of a Contract is under consideration may request in writing, fourteen days prior to the expiration of the time for withdrawal of Bids, that the Owner furnish to the Bidder reasonable evidence that financial arrangements have been made to fulfill the Owner's obligations under the Contract. The Owner shall then furnish such~~

~~reasonable evidence to the Bidder no later than seven days prior to the expiration of the time for withdrawal of Bids. Unless such reasonable evidence is furnished within the allotted time, the Bidder will not be required to execute the Agreement between the Owner and Contractor.~~

~~§ 6.3.1 After notification of selection for the award of the Contract, the Bidder shall, as soon as practicable within three (3) calendar days or as stipulated in the Bidding Documents, submit in writing to the Owner through the Architect:~~

~~...~~

- ~~.3 names of persons or entities (including those who are to furnish materials or equipment fabricated to a special design) proposed for the principal portions of the Work.~~
- ~~.4 The name of the Project Superintendent and Project Manager together with the resume of qualifications of each;~~
- ~~.5 Nonresident Contractor shall submit a letter from an attorney as required by Subparagraph 11.1.2 below and;~~
- ~~.6 Engineering Firm or Testing Laboratory for testing as specified.~~

~~PAGE 7~~

~~§ 6.3.5 The Contractor shall, within ten (10) calendar days of receiving Contract Forms for signature, furnish to the Owner the following items, along with the signed contract, or the Bid Security will be forfeited automatically without further delay:~~

- ~~.1 A Signed Construction Contract;~~
- ~~.2 Performance Bond and Labor and Material Payment Bond (originals) on all Bids over \$10,000.00;~~
- ~~.3 Certificate of Insurance and copy of Builder's Risk Policy (original), as identified in the specifications;~~
- ~~.4 Schedule of Values; and~~
- ~~.5 Federal Immigration Law Compliance: E-Verify enrollment documentation.~~

~~§ 6.3.6 The Bid Check or Bond of the three (3) lowest Bidders will not be returned until after the Construction Contract is executed.~~

~~...~~

~~(If Payment or Performance Bonds are to be in an amount other than 100% of the Contract Sum, indicate the dollar amount or percentage of the Contract Sum.)~~

~~§ 7.1.4 A Surety authorized to do business in the State of Alabama shall issue Performance Bond and Labor and Material Payment Bond, as required by the Contract Documents. If the project cost is \$50,000.00 or more, the Surety must have a minimum rating of A/Class VI as reported by the latest issue of Best's Key Rating Guide Property-Casualty, published by Alfred M. Best Company, Inc.~~

~~...~~

~~§ 7.2.1 The Bidder shall deliver the required bonds to the Owner not later than three days following the date of execution of the Contract. If the Work is to commence sooner in response to a letter of intent, the Bidder shall, prior to commencement of the Work, submit evidence satisfactory to the Owner that such bonds will be furnished and delivered in accordance with this Section 7.2.1 ten (10) calendar days from receiving the Construction Contract forms for signature.~~

~~§ 7.2.2 Unless otherwise provided, the bonds shall be written on AIA Document A312, Performance Bond and Payment Bond. The bonds shall be written on City's Performance Bond and Labor and Material Payment Bond forms.~~

~~PAGE 8~~

**ARTICLE 8 — ENUMERATION OF THE PROPOSED CONTRACT DOCUMENTS**

**ARTICLE 8 FORM OF AGREEMENT BETWEEN OWNER AND CONTRACTOR**

Unless otherwise required in the Bidding Documents, the Agreement for the Work will be written on AIA Document A101, Standard Form of Agreement Between Owner and Contractor Where the Basis of Payment Is a Stipulated Sum.

§ 8.1.1 AIA Document A101, Standard Form of Agreement Between Owner and Contractor where the Basis of Payment is a stipulated sum will be edited electronically and include the standard signatures as required by the City of Mobile.

**ARTICLE 9 NONDISCRIMINATION**

§9.1.1 Contractor shall comply with all Federal, State and local laws concerning nondiscrimination, including but not limited to City of Mobile Ordinance No. 14-034 which requires, *inter alia*, that all contractors performing work for the City of Mobile not discriminate on the basis of race, creed, color, national origin or disability, require that all subcontractors they engage do the same, and make every reasonable effort to assure that fifteen percent of the work performed under contract be awarded to socially and economically disadvantaged individuals and business entities. Contractor shall provide a completed copy of the City of Mobile Subcontracting and Major Supplier Plan with the Bid Form, for bids of \$250,000.00 or greater.

**ARTICLE 10 USE OF DOMESTIC PRODUCTS**

§ 10.1.1 Section 39-3-1 Code of Alabama provides that the Contractor agrees, in the execution of this contract, to use material supplies and products manufactured, mined, processed or otherwise produced in the United States or its territories, if available at reasonable prices, and that breach of this agreement by the Contractor shall result in the assessment of liquidated damages in an amount not less than \$500 nor more than 20 percent of the gross amount of the contract price.

§ 10.1.2 Section 39-3-4, Code of Alabama provides that the Contractor for a municipal construction project, financed by the State of Alabama or any political subdivision thereof, is required to use steel produced within the United States. If the Contractor violates the requirement to use domestic steel, this contract will automatically be revoked and the contractor shall not be entitled to any set-off or recoupment for labor or materials used up to the time of revocation.

**ARTICLE 11 PREFERENCE TO RESIDENT CONTRACTORS**

§ 11.1.1 Except for contracts funded in whole or in part with funds received from a federal agency, preference shall be given to Alabama resident contractors, and a nonresident bidder domiciled in a state having laws granting preference to local contractors shall be awarded the contracts only on the same basis as a the nonresident bidder's state awards contracts to Alabama contractors bidding under similar circumstances. In the letting of public contracts in which any state, county or municipal funds are utilized, resident contractors in Alabama, be they corporations, individuals or partnerships, are to be granted preference over nonresidents in awarding of contracts in the same manner and to the same extent as provided by the laws of the state of domicile of the nonresident.

§ 11.1.2 A successful nonresident bidder shall include in his post bid submittals a written opinion of an attorney at law licensed to practice law in such nonresident bidders' state of domicile, as to the preferences, if any or none, granted by the law of that state to its own business entities whose principal places of business are in that state in the letting of any or all public contracts.

**ARTICLE 12 PRE-BID REQUIREMENTS**

**§ 12.1 STATE OF ALABAMA CONTRACTORS LICENSE**

§ 12.1.1 If the Project total bid amount is \$50,000 or more, a license issued by the State of Alabama Licensing Board for General Contractors is required prior to submitting a bid and the licensed classification and bid limits must cover the type of work in this project. See Invitation to Bid, Section 6 "Bidder Qualifications".

**§ 12.2 A NONRESIDENT BIDDER**

§ 12.2.1 Every bidder shall be registered with the Department of Revenue and with the Alabama Secretary of the State prior to bidding. The Secretary of State's "Business Entity ID" registration number shall be included on the bid form.

**ARTICLE 13 POST-BID REQUIREMENTS**

**§ 13.1 CITY CONTRACTOR'S LICENSE**

13.1.1 A City of Mobile Contractors License is required and must be current before the Contractor signs the Contract.

Contractor must qualify and post \$10,000.00 Surety Bond with the Land Use/Code Administration Department before a Contractors License will be issued by the Revenue Department. Information on the City Contractors License may be obtained by writing or calling:

Land Use/Code Administration  
P. O. Box 1827  
Mobile, Alabama 36633-1827  
Phone: 251.208.7421

Revenue Department  
P. O. Box 1827  
Mobile, Alabama 36633-1827  
251.208.7461

**13.2 E-VERIFY DOCUMENTATION**

**§ 13.2.1** The Contractor agrees that it shall comply with all of the requirements of the State of Alabama Immigration Law (Act. No. 2011-535 as amended by Act. No. 2012-491, Alabama Code (1975) Section 31-13-1, et. Seq., See Section 31-13-9), and the provisions of said Law, including all penalties for violation thereof, are incorporated therein.

**13.3 PUBLIC CONTRACTS WITH ENTITIES ENGAGING IN CERTAIN BOYCOTT ACTIVITIES**

**§ 13.3** The Contractor represents and agrees that it is not currently engaged in, nor will engage in, any boycott of a person or entity based in or doing business with a jurisdiction with which the State of Alabama can enjoy open trade.

**§ 8.1** Copies of the proposed Contract Documents have been made available to the Bidder and consist of the following documents:

- .1** — AIA Document A101™ 2017, Standard Form of Agreement Between Owner and Contractor, unless otherwise stated below.  
*(Insert the complete AIA Document number, including year, and Document title.)*
  
- .2** — AIA Document A101™ 2017, Exhibit A, Insurance and Bonds, unless otherwise stated below.  
*(Insert the complete AIA Document number, including year, and Document title.)*
  
- .3** — AIA Document A201™ 2017, General Conditions of the Contract for Construction, unless otherwise stated below.  
*(Insert the complete AIA Document number, including year, and Document title.)*
  
- .4** — Building Information Modeling Exhibit, if completed:
  
- .5** — Drawings

| Number | Title | Date |
|--------|-------|------|
|--------|-------|------|

- .6** — Specifications

| Section | Title | Date | Pages |
|---------|-------|------|-------|
|---------|-------|------|-------|

**.7—Addenda:**

| <b>Number</b> | <b>Date</b> | <b>Pages</b> |
|---------------|-------------|--------------|
|---------------|-------------|--------------|

**.8—Other Exhibits:**

*(Check all boxes that apply and include appropriate information identifying the exhibit where required.)*

AIA Document E204™-2017, Sustainable Projects Exhibit, dated as indicated below:  
*(Insert the date of the E204-2017.)*

—

The Sustainability Plan:

| <b>Title</b> | <b>Date</b> | <b>Pages</b> |
|--------------|-------------|--------------|
|--------------|-------------|--------------|

Supplementary and other Conditions of the Contract:

| <b>Document</b> | <b>Title</b> | <b>Date</b> | <b>Pages</b> |
|-----------------|--------------|-------------|--------------|
|-----------------|--------------|-------------|--------------|

**.9—Other documents listed below:**

*(List here any additional documents that are intended to form part of the Proposed Contract Documents.)*

## **Certification of Document's Authenticity**

**AIA® Document D401™ – 2003**

I, \_\_\_\_\_, hereby certify, to the best of my knowledge, information and belief, that I created the attached final document simultaneously with its associated Additions and Deletions Report and this certification at 14:25:32 ET on 01/30/2025 under Order No. 3104238820 from AIA Contract Documents software and that in preparing the attached final document I made no changes to the original text of AIA® Document A701™ – 2018, Instructions to Bidders, other than those additions and deletions shown in the associated Additions and Deletions Report.

\_\_\_\_\_  
*(Signed)*

\_\_\_\_\_  
*(Title)*

\_\_\_\_\_  
*(Dated)*

**SECTION 00300**  
**SUPPLEMENTARY INSTRUCTIONS TO BIDDERS**

**THE ATTENTION OF ALL BIDDERS IS CALLED TO THE FOLLOWING INSTRUCTIONS AND CONDITIONS:**

I. BIDDING DOCUMENTS:

- A. Bidders may obtain complete sets of Bid Documents and Specifications (Project Manual) from the Department of Architectural Engineering as listed in the Invitation to Bid.
- B. Bidders shall use the complete set of documents in preparing their bid. Neither the City of Mobile nor the Engineer (Architect) assume responsibility for errors or misinterpretations resulting from use of an incomplete set of documents.

2. INTERPRETATION OF BID DOCUMENTS:

- A. Bidders shall carefully study and compare the Bidding Documents and compare various components of the Bidding Documents with each other, shall examine the site and local conditions and shall at once report to the Project Manager any errors, inconsistencies or ambiguities discovered.
- B. Bidders requiring clarification or interpretation of the Bidding Documents shall make a written request to the Project Manager by 3:00 PM at least five (5) calendar days prior to the date for receipt of Bids. E-mail requests are required and should be addressed to [roger.washington@cityofmobile.org](mailto:roger.washington@cityofmobile.org). Interpretations, corrections and changes to the Bidding Documents will be made by a formal, written Addendum. Interpretations, corrections and changes to the Bidding Documents made in any other manner will not be binding, and Bidders shall not rely on them.
- C. Any discrepancy not resolved prior to Bidding shall be bid by the Contractor to provide for the most costly and/or restrictive interpretation of the documents.

3. BIDDING PROCEDURES:

- A. No Bid will be considered unless made out and submitted on a copy of the Bid Form as set forth by the Bid Documents.
- B. All blanks on the Bid Form shall be legibly executed in a non-erasable medium.
- C. Sums shall be expressed in both words and figures. In case of discrepancy, the amount written in words shall govern.
- D. Interlineations, alterations and erasures must be initialed by the signer of the Bid.
- E. All requested Alternates, Unit Prices and Allowances shall be bid as indicated on the Bid Form and the Bid Documents.
- F. Addenda shall be considered as a part of the Bid Documents and those issued

prior to the opening of Bids shall be acknowledged on the Bid Form and any adjustment in cost shall be included in the Contract Sum.

4. BID SECURITY:

- A. A Cashier's Check drawn on a bank registered to do business in the State of Alabama and which is a member of the Federal Deposit Insurance Corporation, or Bid Bond payable to Owner, City of Mobile, in the amount of 5% of the Base Bid, but in no event more than \$10,000.00, must accompany bid. By submitting a Bid Security, the Bidder pledges to enter into a Contract with the City of Mobile on the terms stated in the Bid, and will, if required, furnish bonds covering faithful performance of the Contract and required insurance certificate. Should the Bidder refuse to enter into such Contract or fail to furnish such bonds or insurance or any other required document, the amount of the Bid security shall be forfeited to the Owner as liquidated damages, not as a penalty.
- B. Bid Bond shall be valid for a minimum of sixty (60) days from the date of the Bid. The Owner reserves the right to retain the security of all Bidders until the successful Bidder enters into the Contract or until (60) days after Bid opening, whichever is sooner.
- C. Bonds must be issued by a Surety licensed to do business in the State of Alabama. If the project cost is more than \$50,000.00 the Surety must have a minimum rating of A/Class VI as reported by the latest issue of Best's Key Rating Guide Property-Casualty published by Alfred M. Best Company, Inc.
- D. Power of Attorney is required for all Bonds.
- E. The Surety company shall be required to execute AIA Document G-707, "Consent of Surety to Final Payment" prior to Final Payment of retainage being made to the Contractor.

5. EXAMINATION OF DOCUMENTS AND SITE WORK:

- A. Before submitting a Bid, Bidders should carefully examine the Bid Documents, visit the site of the Work, including attendance at the Pre-Bid conference, fully inform themselves as to existing conditions and limitations, and include in the Bid a sum to cover the cost of all items included in the Contract and necessary to perform the Work. The submission of a Bid will be considered as conclusive evidence that the Bidder has made such examination.

6. SUBMISSION OF BIDS:

- A. Bid, with Bid Security, Sales Tax Form C-3A, City of Mobile Subcontracting & Major Supplier Plan and other supporting data specified, shall be contained in a sealed, opaque envelope, approximately 9 x 12 inches or larger and be marked on the outside with the words "SEALED BID FOR PINEHILL RECYCLING CENTER - PROJECT NUMBER: PW-064-24", the Bid Date, and Contractor's name, address, and City of Mobile Business License number. And, if bidding in an amount \$50,000 or greater, the State of Alabama General Contractor's



License number and classification of the Bidder issued by the State of Alabama Licensing Board for General Contractors shall be written on the envelope.

- B. Bids shall be deposited at the designated location prior to the time and date for receipt of Bids. Bids received after the time and date specified in the Invitation to Bid, or as modified by Addendum, will not be considered. Late Bids will be returned to the Bidder unopened.
- C. The Bidder shall assume full responsibility for timely delivery at the location designated for receipt of Bids.
- D. Oral, telephonic, facsimile or other electronically transmitted bids will not be considered.

7. MODIFICATION OR WITHDRAWAL OF BIDS:

- A. A Bid may not be modified, withdrawn, or canceled by the Bidder for a period of sixty (60) days following the time and date designated for receipt of bids, and each Bidder so agrees in submitting a Bid.

8. CONSIDERATION AND AWARD OF BIDS:

- A. At the discretion of the City, the properly identified Bids received on time will be publicly opened and will be read aloud.
- B. The City shall have the right to reject any and all Bids. A Bid not accompanied by a required Bid security or a Bid which is in any way incomplete or irregular is subject to rejection.
- C. It is the intent of the City to award a Contract to the lowest qualified Bidder provided the Bid has been submitted in accordance with the requirements of the Bidding Documents and does not exceed the funds available. The City shall have the right to waive informalities and irregularities in a Bid received and to accept the Bid which, in the City's judgment, is in the City's best interest.
- D. The award shall be based on the lowest Total Bid for the Base Bid and any allowances, plus any alternates and/or options that may be accepted, as listed on the Bid Form.

9. PROOF OF COMPETENCY OF BIDDER:

- A. Bidders may be required to furnish evidence satisfactory to the City of Mobile that they have sufficient means and experience in the types of work called for to assure the completion of the Contract in a satisfactory manner.

10. SIGNING OF CONTRACT:

- A. The Standard Agreement between the City of Mobile and the Contractor, included herein, shall serve as the Agreement between the City and the Contractor.
- B. The Bidder to whom the Contract is awarded shall, within ten (10) calendar days of receiving the Contract Forms, properly execute and deliver to the Owner, the following items with the signed Agreement:
  - (1). Performance Bond and Labor and Material Payment Bond (originals);

- (2). Certificate of Insurance (original) with endorsements to City of Mobile;
  - (3). Evidence of enrollment in the E-Verify program.
  - (4). Other documentation as required by the Contract Documents.
- C. Failure or refusal to sign the Agreement or to provide Certificates of Insurance in a form satisfactory to the City of Mobile, E-Verify verification, or other required documentation, shall subject the Bidder to immediate forfeiture of Bid Security.
- D. On all documents: City of Mobile Business License, the Alabama Secretary of State Business Identity, the Alabama Secretary of State Certificate of Authority (out of state contractors), E-verify documentation, and ACORD Insurance Form, the Contractor's name shall be EXACTLY the same.

11. NONDISCRIMINATION:

- A. Contractor shall comply with all Federal, State and local laws concerning nondiscrimination, including but not limited to City of Mobile Ordinance No. 14-034 which requires, inter alia, that all contractors performing work for the City of Mobile not discriminate on the basis of race, creed, color, national origin or disability, require that all subcontractors they engage do the same, and make every reasonable effort to assure that fifteen percent of the work performed under contract be awarded to socially and economically disadvantaged individuals and business entities.

12. AMERICANS WITH DISABILITIES ACT (ADA):

- A. Bidders shall comply with the provisions of the Americans with Disabilities Act (ADA) of 1990 which prohibits discrimination against individuals with disabilities.

13. USE OF DOMESTIC PRODUCTS:

- A. Section 39-3-1, Alabama Code, 1975, provides that the Contractor agree, in the execution of this Contract, to use materials, supplies and products manufactured, mined, processed or otherwise produced in the United States or its territories, if available at reasonable prices, and that breach of this Agreement by the Contractor shall result in the assessment of liquidated damages in an amount not less than \$500.00 nor more than twenty (20) percent of gross amount of the Contract Price.

14. NON-RESIDENT (OUT OF STATE) CONTRACTORS:

- A. Preference to Resident Contractors: Section 39-3-5, Code of Alabama, 1975, provides that a non-resident (out of State) bidder domiciled in a state which grants a preference to local Contractors is to be awarded a public contract on the same basis as the non-resident bidder's state awards contracts to Alabama bidders. Alabama bidders are given a preference to the same extent that a non-resident bidder receives a preference in his home state. A non-resident bidder must include with any written bid documents a written opinion of an attorney licensed to practice in the non-resident bidder's state declaring what preferences, if any, exists in the non-resident's state.

- B. Certificate of Authority: All non-resident (out of State) bidders shall be registered with the Alabama Secretary of State and the Alabama Department of Revenue prior to submitting a Bid. Provide the Secretary of State Business "Entity ID Number" on the Bid Form in the space provided.

15. ALABAMA IMMIGRATION ACT:

- A. The State of Alabama Immigration Law (Act No. 2011-535 as amended by Act No. 2012-491), requires that Contractors not violate federal immigration law or knowingly employ, hire for employment, or continue to employ an unauthorized alien within the State of Alabama. In addition, Contractors are required to enroll in the federal E-Verify program and submit verification of enrollment to the City of Mobile within ten (10) days of receiving the contract forms (see Section 00600).

16. CITY OF MOBILE BUSINESS LICENSE:

- A. A City of Mobile Business License is required and must be current at time of contract award and throughout contract period.

17. CITY OF MOBILE CONTRACTOR'S BUSINESS LICENSE:

- A. A City of Mobile Contractor's Business License is required and must be current when contractor signs the contract and throughout contract period.
- B. Contractor must qualify and post a \$10,000 surety bond with the Land Use/Code Administration Department before a Contractor's Business License will be issued by the Revenue Department. Information on the City Contractor's License may be obtained by writing or calling:

Land Use/Code Administration  
P.O. Box 1827  
Mobile, Alabama 36633-1827  
Phone: 251-208-7421

Revenue Department  
P.O. Box 1827  
Mobile, Alabama 36633-1827  
Phone: 251-208-7461

18. CITY OF MOBILE BUILDING PERMIT:

- A. A City of Mobile Building Permit/Electrical Permit/Plumbing Permit/HVAC Permit/Whatever Permit is required and shall be obtained from the Land Use/Code Administration Department, but at no cost to the Contractor.
- B. Contractor is responsible for ensuring that all inspections are successfully performed in accordance with City of Mobile regulations.

19. CONSTRUCTION SCHEDULE AND ACCESS:

- A. The project shall be completed within seventy (60) calendar days from the date indicated by the Notice to Proceed.
- B. At all buildings that will remain in use throughout the Construction period, the Contractor is directed to coordinate all areas of work and scheduling of work with

the Owner. Within five days of the bid opening, the Apparent Low Bidder shall meet with the Owner to discuss Owner scheduling and priorities. Apparent Low Bidder shall then provide a proposed schedule within 5 calendar days of the initial meeting for Owner review and approval.

- C. Contractor shall have access to the construction site seven days a week, from dawn to dusk.
- D. The Contractor may be allowed additional construction days due to inclement conditions (“rain days”) only as such are appropriately documented and are in excess of the NOAA/National Weather Service average (previous 5 years) for the given month. A “rain day” is defined as more than a “trace” (0.10”) of rain falling within a given 24 hour period. The Contractor shall provide documentation and formally request any “rain days” they feel are legitimately due. Documentation shall be submitted to the Project Manager, in writing, within ten (10) calendar days of the rain event. Claim shall include documentation of trades adversely impacted and the impacted activities of each trade.

## 20. SITE CONSIDERATIONS:

- A. It is the Contractor’s responsibility to carefully remove and store any items not permanently installed within the work areas. We strongly recommend that the Contractor photograph, videotape or in some manner document any features to be removed and their condition, prior to removal.
- B. Noise and strong smells shall be isolated or kept to a minimum when adjacent portions of the site are occupied.
- C. Contractor shall be responsible to leave the work area and adjacent site clear of equipment and debris, etc. at the end of each work day. All final cleaning is the responsibility of the Contractor and shall be executed prior to acceptance for reuse of any portion of the site.
- D. A dumpster and lay down area for Contractor materials and staging may be located at the site and located per the direction of the Owner. The Contractor is responsible for the removal of the dumpster, any storage containers and any security fencing, temporary erosion control (BMPs), etc. as soon as practical after their use by the Contractor or the work is complete.

## 21. SALES AND USE TAX EXEMPTION:

- A. As per the State of Alabama ACT 2013-205, the Alabama Department of Revenue (ADOR) has been granted the authority to issue a “Certificate of Exemption from Sales and Use Tax for Governmental Entities” on construction projects. Therefore, this project shall qualify for State of Alabama Sales and Use Tax Exemptions under this ACT. It is the responsibility of the Bidder to confirm the potential tax exempt status of their bid with the ADOR and include any such savings in their bid, as well as accounting for same on their bid form attachment Sales Tax Form C-3A.
- B. The full text of ACT 2013-205 is available on the State of Alabama Building Commission web-site at [www.bc.alabama.gov](http://www.bc.alabama.gov) .

22. SUBMISSION OF LIEN WAIVERS AND DBE COMPLIANCE, UTILIZATION REPORTS:

- A. At each monthly Application for Payment submitted to the owner, the Contractor shall provide completed "City of Mobile DBE Compliance, Utilization Reports" and lien waivers, including those from Subcontractors and material suppliers.

23. NOTICE OF COMPLETION:

- A. For Contracts \$50,000 or greater:  
Contractor shall provide proof of publication of Advertisement of Completion for four consecutive weeks in a local newspaper, as required in the Title 39, Section 39-1-1, Subsection (f), of the Code of Alabama. This Advertisement shall not begin until the Project has been accepted by the City of Mobile.
- B. Notice of Completion advertisement shall read as follows:

STATE OF ALABAMA  
COUNTY OF MOBILE  
NOTICE OF COMPLETION

In accordance with Chapter 1, Title 39, Code of Alabama, 1975, NOTICE IS HEREBY given that (COMPANY NAME) has completed the contract for Pinehill Recycling Center - PW-064-24, Mobile, Alabama 36602. All persons having any claims for labor, material or otherwise in connection with this project should immediately notify the Architectural Engineering Department, City of Mobile, P.O. Box 1827, Mobile, Alabama 36633-1827.

- C. Advertisement shall not begin until the Project has been accepted by the City of Mobile as Substantially Complete.

24. CONTRACTOR WARRANTY AND CERTIFICATION:

- A. Upon completion of the contract, the Contractor shall certify under oath that all bills have been paid in full.
- B. Contractor shall provide a one year Labor and Materials Warranty on company letterhead in addition to other warranties required by the Bid Documents.

25. LIQUIDATED DAMAGES

- A. A time charge equal to Two Hundred Fifty Dollars (\$250.00) per calendar day will be made against the Contractor for the entire period that any part of the Work remains uncompleted, or any required closeout documents are not acceptably submitted, for more than thirty (30) calendar days after the time specified for the Substantial Completion for the Work, the amount of which shall be deducted by the owner, and shall be retained by the Owner out of monies otherwise due the Contractor in the final payment, not as a penalty, but as liquidated damages sustained.

END OF SECTION

**SECTION 00400**

**BID FORM**

Copies of the following Bid Forms shall be used. Bids submitted on alternate forms may be rejected. Fill in all blank spaces with an appropriate entry. Bid Form must be signed by an officer of the company and notarized.

**TO: City of Mobile, 205 Government St., P.O. Box 1827, Mobile, AL, 36633**

**REF: PROJECT NO.: PW-062-24**  
**PROJECT NAME: Pinehill Recycling Center**  
**PROJECT LOCATION: 308 Pinehill Drive**  
**Mobile, Alabama 36606**

In compliance with the Bid Documents and having carefully and thoroughly examined said documents for the subject Work prepared by the City of Mobile, Architectural Engineering Department and Dorsey & Dorsey Engineering, Inc. dated January 23, 2025; and all Addendum (a) Number(s) \_\_\_\_\_, dated \_\_\_\_\_, 2025 (CAUTION: before submitting any bid it is the Bidder's responsibility to check with the Architectural Engineering Department for all Addenda or special instructions that may impact the Bid) thereto, receipt of which is hereby acknowledged, the premises and all conditions affecting the Work prior to making this Proposal, the Undersigned Bidder, hereby

**COMPANY NAME:** \_\_\_\_\_

**ADDRESS:** \_\_\_\_\_ **PHONE** \_\_\_\_\_

**ALABAMA GENERAL CONTRACTOR LICENSE NO.** \_\_\_\_\_

**CITY OF MOBILE BUSINESS LICENSE NO.** \_\_\_\_\_

**SECRETARY OF STATE OF ALABAMA BUSINESS IDENTITY NO.** \_\_\_\_\_

**SECRETARY OF STATE OF ALABAMA ACCOUNT NO.** \_\_\_\_\_

(Note: Secretary of State Account Number shall be filled in only by non-resident bidders)

(Check one)  A Corporation  A Partnership  An Individual Doing Business

hereby proposes to furnish all labor, materials, tools, equipment, and supplies and to sustain all the expenses incurred in performing the Work on the above captioned Project in accordance with the terms of the Contract Documents, and all applicable laws and regulations for the sum listed below. The initial term of the Contract shall extend for sixty (60) calendar days from the date of the Notice to Proceed.

**Base Bid:** \$ \_\_\_\_\_ .00

**Contingency Allowance:** + \$ 10,000.00

**Total Base Bid:** \$ \_\_\_\_\_ .00

(Fill in here and in Total Bid below)

**TOTAL BASE BID:** \_\_\_\_\_

\_\_\_\_\_ Dollars, (\$ \_\_\_\_\_ .00)  
(Amount in Words) (Amount in Figures)

Unit Price #1: Provide labor and all other necessary construction components for installation of 1 Square Foot of asphalt surfacing.

\$ \_\_\_\_\_ SF

Unit Price #2: Provide labor and all other necessary construction components for installation of 1 Square Foot of concrete surfacing.

\$ \_\_\_\_\_ SF

(Note: Show amount in both words and figures. In case of discrepancy, the amount in words shall govern). **Bids shall be provided in whole dollar amount with no cents.**

**CONTINGENCY ALLOWANCE:** \$10,000.00 lump sum Contingency Allowance shall be included in the Total Bid for work related to unforeseen conditions as approved by the Owner.

**BID SECURITY:** The undersigned Bidder agrees that the attached Bid Security, as a Cashier's Check drawn on a bank registered to do business in the State of Alabama and which is a member of the Federal Deposit Insurance Corporation, or a Bid Bond, made payable to the City of Mobile, in the amount of 5% of the bid amount, but in no event more than \$10,000, as the proper measure of liquidated damages which the City will sustain by the failure of the undersigned to execute the Contract. Said Bid Security shall become the property of the City of Mobile as liquidated damages as specified in the Contract Documents.

**AMERICANS WITH DISABILITIES ACT (ADA):** The undersigned Bidder agrees to fully comply with all requirements of the Americans with Disabilities Act of 1990 and the Amendment Act.

**NONDISCRIMINATION:** Contractor shall comply with all Federal, State and local laws concerning nondiscrimination, including but not limited to City of Mobile Ordinance No. 14-034 which requires, *inter alia*, that all contractors performing work for the City of Mobile not discriminate on the basis of race, creed, color, national origin or disability, require that all subcontractors they engage do the same, and make every reasonable effort to assure that fifteen percent of the work performed under contract be awarded to socially and economically disadvantaged individuals and business entities.

**SIGNATURE:** If the undersigned Bidder is incorporated, the entire legal title of the company followed by "a corporation" should be used. If Bidder is an individual, then that individual's full legal name followed by doing business as (d/b/a) and name of firm, if any, should be used. If Bidder is a partnership, then full name of each partner should be listed followed by "d/b/a" and name of firm, if any.

Ensure that name and exact arrangement thereof is the same on all forms submitted with this Bid. If a word is abbreviated in the official company name, such as "Co.", then use that abbreviation. If not abbreviated in the official name, spell out.

Bidder agrees not to revoke or withdraw this Bid until sixty (60) calendar days following the time and date for receipt of bids. If notified in writing of the acceptance of this Bid within this time period, Bidder agrees to execute a Contract based on this Bid on the proscribed form within ten (10) calendar days of said notification and to furnish Performance Bond and Materials and Payment Bond as specified.

**COMPANY NAME:** \_\_\_\_\_  
(Printed or Typed)

**BY:** \_\_\_\_\_  
(Signature of Company Officer)

**COMPANY OFFICER:** \_\_\_\_\_  
(Printed or Typed)

**TITLE** \_\_\_\_\_ **DATE** \_\_\_\_\_, 2025  
(Printed or Typed)

Sworn to and subscribed before me this \_\_\_\_\_ day of \_\_\_\_\_ 2025

\_\_\_\_\_  
Notary Public

- Attachments: 1. Bid Security, with Power of Attorney  
2. Secretary of State Authorization (Out of state bidders only)  
3. Sales Tax Form C-3A  
4. Supplier Diversity Subcontracting & Major Supplier Plan

END OF BID FORM



**ACCOUNTING OF SALES TAX  
ATTACHMENT TO BID FORM SECTION 00400  
SALES TAX FORM C-3A**

To: City of Mobile

Date: \_\_\_\_\_

Name of Project: PINEHILL RECYCLING CENTER  
Project Number: PW-062-24

**SALES TAX ACCOUNTING**

Pursuant to Act 2013-205, Section 1(g) the Contractor accounts for the sales tax NOT included in the bid proposal form as follows:

ESTIMATED SALES TAX AMOUNT

**OPTION ONE BASE BID:** \$ \_\_\_\_\_

**Failure to provide an accounting of sales tax shall render the bid non-responsive. Other than determining responsiveness, sales tax accounting shall not affect the bid pricing nor be considered in the determination of the lowest responsible and responsive bidder.**

Legal Name of Bidder \_\_\_\_\_

Mailing Address \_\_\_\_\_

\*By (Legal Signature) \_\_\_\_\_

\*Name (type or print) \_\_\_\_\_ (Seal)

\*Title \_\_\_\_\_

Telephone Number \_\_\_\_\_



OFFICE OF SUPPLIER DIVERSITY  
**CITY OF MOBILE**  
Subcontracting and Major Supplier Plan

Contact Office of Supplier Diversity for  
questions on completing this form.  
Via email: Archnique.kidd@cityofmobile.org  
251.208.7967  
205 Government Street, 5<sup>th</sup> Floor

**Bidders and Proposers – Please complete and submit these forms as required by your City of Mobile Bid or Proposal Specification.**

If you are submitting a proposal in response to a Request for Qualifications, Request for Proposal, or other solicitation (“Solicitations”) issued by the City of Mobile, the bid specification may require you to utilize disadvantaged business enterprise (“DBE”) subcontractors and suppliers. If DBE participation is required, you must complete and submit these forms with your proposal. If required, failure to submit this form will render your bid non-responsive. NOTE: To satisfy participation requirements for a federally funded project, you must utilize DBEs certified through the Alabama Unified Certification Program.

If DBE participation is required, and you fail to satisfy the participation requirement, you must show that you made a good faith effort to include such participation; you will be required to submit DBE Compliance Form 2 and include additional information if needed. When so required, failure to address adequately the good faith effort factors on Form 2 will render your bid or proposal non-responsive. The “good faith effort” factors on Form 2 are not intended to be a mandatory, exhaustive, or exclusive.

You are encouraged to work with the City of Mobile Supplier Diversity Manager when preparing this form. Please consult with the City Supplier Diversity Manager for a list of eligible DBEs. The “good faith effort” factors on **Form 2** are not intended to be mandatory, exhaustive, or exclusive; they are a tool to help you, and the City of Mobile, determine whether you made efforts which, by their scope, intensity, and appropriateness to the objective, would reasonably be expected to fulfill the participation requirement.

About “**DBEs**”: Disadvantaged business enterprise or DBE means a for-profit small business concern (1) That is at least 51 percent owned by one or more individuals who are both socially and economically disadvantaged or, in the case of a corporation, in which 51 percent of the stock is owned by one or more such individuals; and (2) whose management and daily business operations are controlled by one or more of the socially and economically disadvantaged individuals who own it.

About “**Good Faith**” **Effort**: Good faith efforts means efforts to achieve a DBE goal or other requirement of this part which, by their scope, intensity, and appropriateness to the objective, can reasonably be expected to fulfill the program requirement. The City of Mobile expects contractors holding large contracts to recruit and engage DBEs to be a part of their team.

Failure to submit this form, when so required by the bid or proposal specification, will render your bid non-responsive.



OFFICE OF SUPPLIER DIVERSITY  
**CITY OF MOBILE**  
Subcontracting and Major Supplier Plan

Contact Office of Supplier Diversity for  
questions on completing this form.  
Via email: Archnique.kidd@cityofmobile.org  
251.208.7967  
205 Government Street, 5<sup>th</sup> Floor

**FORM 1: Background and Plan**

**Section I. Information about your company**

|           |  |
|-----------|--|
| Company   |  |
| Address   |  |
| Telephone |  |
| E-Mail    |  |

|                                |   |
|--------------------------------|---|
| RFP/RFQ Solicitation Number    |   |
| Project Description            |   |
| Is your company a DBE company? | Yes <input type="checkbox"/> No <input type="checkbox"/>  |
| Work force demographics        | Male _____ Female _____ Minority _____ Non-minority _____ SDVO _____<br>Total #of Employees _____ |

**Subcontractor/Major Supplier Plan submitted by:**

Printed Name: \_\_\_\_\_

Signature: \_\_\_\_\_ Date: \_\_\_\_\_

Title: \_\_\_\_\_

The following employee will be designated as the **DBE Liaison** for all communication regarding DBE participation including documentation for DBE participation and maintenance of records of Good Faith Efforts for this contract award:

Name: \_\_\_\_\_ Title: \_\_\_\_\_

Email: \_\_\_\_\_ Phone: \_\_\_\_\_





OFFICE OF SUPPLIER DIVERSITY  
**CITY OF MOBILE**  
Subcontracting and Major Supplier Plan

**Form 2: Good Faith Effort Documentation**

Name of Bidder: \_\_\_\_\_

Contact Person: \_\_\_\_\_ Phone \_\_\_\_\_ Email \_\_\_\_\_

Please complete this form if you are unable to identify DBE subcontractors or suppliers to reach 15% of the value of your bid.

| YES ( <input type="checkbox"/> ) | NO ( <input type="checkbox"/> ) | <b>Did you do these suggested areas for DBE recruitment and engagement</b>  |
|----------------------------------|---------------------------------|---|
|                                  |                                 | <b>PRE-BID MEETING(S):</b> The bidder attended all pre-bid meetings scheduled by the City to inform DBEs of contracting and subcontracting opportunities.   |
|                                  |                                 | <b>CMDBE/ALDOT DBE LIST(S):</b> The bidder utilized the Office of Supplier Diversity's list or lists of certified through the Alabama Department of Transportation UCP DBE Listing  |
|                                  |                                 | <b>SMALL CONTRACT(S):</b> The bidder selected specific portions of the work to be performed by DBEs in order to increase the likelihood of meeting the DBE goals (including breaking down contracts into smaller units to facilitate DBE participation). Consider support services, including insurance, accounting, temporary labor, and transportation, landscaping, and janitorial as potential areas for DBE use.   |
|                                  |                                 | <b>FOLLOW-UP:</b> The bidder followed-up initial indications of interest by DBEs by contacting those DBEs to determine with certainty if they remained interested in bidding.   |
|                                  |                                 | <b>GOOD FAITH NEGOTIATIONS:</b> The bidder negotiated in good faith with interested DBEs and did not reject DBEs as unqualified without sound business reasons based on a thorough investigation of their capabilities. Bidders are not expected to engage unqualified subcontractors or subcontractors whose pricing, after negotiation, remains excessive or unreasonable. (Please document qualification deficiencies or unreasonable pricing if it prevented your engagement of specific DBE subcontractors.) |
|                                  |                                 | <b>ADVERTISEMENT:</b> The bidder advertised in general circulation and/or trade association publications concerning subcontracting opportunities and allowed DBEs reasonable time to respond.   |
|                                  |                                 | <b>INTERNET ADVERTISING:</b> The bidder advertised DBE and/or subcontracting opportunities in the newspaper or other internet portals that are accessible to DBEs and/or potential subcontractors.  |



OFFICE OF SUPPLIER DIVERSITY  
**CITY OF MOBILE**  
 Subcontracting and Major Supplier Plan

|  |  |  |
|--|--|--|
|  |  |  |
|  |  | <b>INFORMATION:</b> The bidder provided interested DBEs with adequate information about the plans, specifications and requirements of the subcontract.   |
|  |  | <b>WRITTEN NOTICE(S):</b> The bidder/proposer took the necessary steps to provide written notice in a manner reasonably calculated to inform DBEs of subcontracting opportunities and allowed sufficient time for them to participate effectively.             |
|  |  | <b>COMMUNITY RESOURCES:</b> The bidder/proposer used the services of available community organizations, small and/or disadvantaged business assistance offices and other organizations that provided assistance in the recruitment and placement of DBE firms. |

**CONTRACT RECORDS:**

The bidder/proposer has maintained the following records for each DBE that has bid on the subcontracting opportunity:

1. Name, address, email address and telephone number
2. A description of information provided by the bidder/proposer or subcontractor; and
3. A statement of whether an agreement was reached, and if not, why not, including any reasons for concluding that the DBE was unqualified to perform the job.

**Section 2(B)**

\_\_\_\_\_ There are not ways to break out 15% of the value of this contract for subcontractors / suppliers. Provide further detail in Section 2(c) if the inability to break-out 15% of the value of the contract was the reason, or a reason, you could not meet the participation requirements.

\_\_\_\_\_ Could not find sufficient DBEs to provide subcontracting or supplier services.

\_\_\_\_\_ DBEs were available but did not have sufficient qualifications or experience to meet the needs of this contract.

Please indicate additional efforts you have taken to recruit and engage DBEs. \_\_\_\_\_

\_\_\_\_\_  
 \_\_\_\_\_

**SECTION 00500**  
**STANDARD FORM OF AGREEMENT BETWEEN OWNER AND CONTRACTOR**

**PART 1 GENERAL**

- A. This section includes the STANDARD FORM OF AGREEMENT BETWEEN OWNER and CONTRACTOR, AIA Document A101, wherein the basis of payment is a Stipulated Sum; the document has been electronically modified to meet the Owner's requirements and shall be used for the Project.

# DRAFT AIA® Document A101® - 2017

## Standard Form of Agreement Between Owner and Contractor where the basis of payment is a Stipulated Sum

**AGREEMENT** made as of the « » day of « » in the year « »  
(In words, indicate day, month and year.)

**BETWEEN** the Owner:  
(Name, legal status, address and other information)

«City of Mobile »« »  
«P.O. Box 1827 »  
«Mobile, Alabama 36633-1827 »  
« »

and the Contractor:  
(Name, legal status, address and other information)

«Contractor company name »  
« Contractor company Address »  
« »  
« City of Mobile Business License Number: »  
«Secretary of State Registration Number: »

for the following Project:  
(Name, location and detailed description)

«Pinehill Recycling Center »  
«308 Pinehill Drive »  
«Mobile, Alabama 36606 »  
«PW-062-24 »  
«Contractor shall provide all labor and materials necessary for preparation of site work for placement of a modular office space to be installed by others.»

The Architect:  
(Name, legal status, address and other information)

«Architectural Engineering Department »  
«P.O. Box 1827 »  
«Mobile, Alabama 36633-182702 »  
«Dorsey & Dorsey Engineering, Inc. »  
«6051 Airport Blvd »  
«Mobile, AL 36608 »

The Owner and Contractor agree as follows.

**ADDITIONS AND DELETIONS:**  
The author of this document has added information needed for its completion. The author may also have revised the text of the original AIA standard form. An *Additions and Deletions Report* that notes added information as well as revisions to the standard form text is available from the author and should be reviewed.

This document has important legal consequences. Consultation with an attorney is encouraged with respect to its completion or modification.

The parties should complete A101®-2017, Exhibit A, Insurance and Bonds, contemporaneously with this Agreement. AIA Document A201®-2017, General Conditions of the Contract for Construction, is adopted in this document by reference. Do not use with other general conditions unless this document is modified.

**ELECTRONIC COPYING** of any portion of this AIA® Document to another electronic file is prohibited and constitutes a violation of copyright laws as set forth in the footer of this document.



## TABLE OF ARTICLES

|   |  |
|---|--|
| 1 | THE CONTRACT DOCUMENTS                                 |
| 2 | THE WORK OF THIS CONTRACT                              |
| 3 | DATE OF COMMENCEMENT AND SUBSTANTIAL COMPLETION        |
| 4 | CONTRACT SUM   |
| 5 | PAYMENTS   |
| 6 | DISPUTE RESOLUTION                                     |
| 7 | TERMINATION OR SUSPENSION                              |
| 8 | MISCELLANEOUS PROVISIONS                               |
| 9 | ENUMERATION OF CONTRACT DOCUMENTS, INSURANCE AND BONDS |

### ARTICLE 1 THE CONTRACT DOCUMENTS

The Contract Documents consist of this Agreement, Conditions of the Contract (General, Supplementary, and other Conditions), Drawings, Specifications, Addenda issued prior to execution of this Agreement, other documents listed in this Agreement, and Modifications issued after execution of this Agreement, all of which form the Contract, and are as fully a part of the Contract as if attached to this Agreement or repeated herein. The Contract represents the entire and integrated agreement between the parties hereto and supersedes prior negotiations, representations, or agreements, either written or oral. An enumeration of the Contract Documents, other than a Modification, appears in Article 9.

### ARTICLE 2 THE WORK OF THIS CONTRACT

The Contractor shall fully execute the Work described in the Contract Documents, except as specifically indicated in the Contract Documents to be the responsibility of others.

### ARTICLE 3 DATE OF COMMENCEMENT AND SUBSTANTIAL COMPLETION

§ 3.1 The date of commencement of the Work shall be:

*(Check one of the following boxes.)*

[  ] A date set forth in a notice to proceed issued by the Owner.

§ 3.2 The Contract Time shall be measured from the date of commencement of the Work.

#### § 3.3 Substantial Completion

§ 3.3.1 Subject to adjustments of the Contract Time as provided in the Contract Documents, the Contractor shall achieve Substantial Completion of the entire Work:

*(Check one of the following boxes and complete the necessary information.)*

[  ] Not later than  (  ) calendar days from the date of the Notice to Proceed for commencement of the Work.

§ 3.3.2 If the Contractor fails to achieve Substantial Completion as provided in this Section 3.3, liquidated damages, if any, shall be assessed as set forth in Section 4.5.

### ARTICLE 4 CONTRACT SUM

§ 4.1 The Owner shall pay the Contractor the Contract Sum in current funds for the Contractor's performance of the Contract. The Contract Sum shall be  "and 00/100" (\$  ), subject to additions and deductions as provided in the Contract Documents.

Base Bid:

Contingency Allowance:

Total Bid:

Alternate: NA

Total Contract Sum:

**§ 4.2 Alternates**

**§ 4.2.1** Alternates, if any, included in the Contract Sum:

| Item | Price |
|------|-------|
| N/A  | N/A   |

**§ 4.3** Allowances, if any, included in the Contract Sum:

*(Identify each allowance.)*

Contingency Allowance: « Ten Thousand and 00/100 » ( «\$10,000.00 » )

- A. Contingency Allowance shall cover cost of material, labor, overhead, profit and other expenses for complete installation of items of additional work as required for a complete, functional project.
- B. Contingency Allowance shall be used for unforeseen conditions not covered in the construction documents.
- C. All extra work under this section must be authorized by the Owner, in writing, prior to materials or undertaking work.
- D. Upon completion of the Work, the unused portion of the Allowance shall be credited back to the Owner in the form of a Change Order.
- E. Allowances are subject to the same provision of AIA 201 Article 7.3.7.

**§ 4.4** Unit prices, if any:

*(Identify the item and state the unit price and quantity limitations, if any, to which the unit price will be applicable.)*

| Item   | Units and Limitations               | Price per Unit (\$0.00) |
|--|-------------------------------------|-------------------------|
| Unit description<br>1. Provide labor and all other necessary construction components for installation of 1 Square Foot of drive surfacing. | Type of unit ex. Sf, Lf, yard<br>SF |                         |
| 2. Provide labor and all other necessary construction components for installation of 1 Square Foot of concrete surfacing.                  | SF                                  |                         |

**§ 4.5** Liquidated damages:

*(Insert terms and conditions for liquidated damages, if any.)*

« A time charge equal to Two Hundred Fifty and 00/100 Dollars (\$250.00) per calendar day will be made against the Contractor for the entire period that any part of the Work remains uncompleted or any required closeouts documents are not acceptably submitted for more than thirty (30) days after the date specified for the substantial Completion of the Work, the amount of which shall be deducted by the owner, and shall be retained by the Owner out of monies otherwise due the Contractor in the final payment, not as a penalty, but as liquidated damages sustained. »

**ARTICLE 5 PAYMENTS**

**§ 5.1 Progress Payments**

**§ 5.1.1** Based upon Applications for Payment submitted to the Architect by the Contractor and Certificates for Payment issued by the Architect, the Owner shall make progress payments on account of the Contract Sum to the Contractor as provided below and elsewhere in the Contract Documents.

**§ 5.1.2** The period covered by each Application for Payment shall be one calendar month ending on the 25<sup>th</sup> of the month.

**§ 5.1.3** Provided that an Application for Payment in acceptable format is received by the Architect not later than the first «1<sup>st</sup>» day of a month, the Owner shall make payment of the amount certified to the Contractor not later than the

tenth «10<sup>th</sup>» day of the «following» month. If an Application for Payment in acceptable format is received by the Architect after the application date fixed above, payment of the amount certified shall be made by the Owner not later than «Forty» («40») days after the Architect receives the Application for Payment.  
(Federal, state or local laws may require payment within a certain period of time.)

§ 5.1.4 Each Application for Payment shall be based on the most recent schedule of values submitted by the Contractor in accordance with the Contract Documents. The schedule of values shall allocate the entire Contract Sum among the various portions of the Work. The schedule of values shall be prepared in such form, and supported by such data to substantiate its accuracy, as the Architect may require. This accepted schedule of values shall be used as a basis for reviewing the Contractor's Applications for Payment.

§ 5.1.5 Applications for Payment shall show the percentage of completion of each portion of the Work as of the end of the period covered by the Application for Payment.

§ 5.1.6 In accordance with AIA Document A201, General Conditions of the Contract for Construction (including Owner's then current Modifications), and subject to other provisions of the Contract Documents, the amount of each progress payment shall be computed as follows:

§ 5.1.6.1 The amount of each progress payment shall first include:

- .1 That portion of the Contract Sum properly allocable to completed Work;
- .2 That portion of the Contract Sum properly allocable to materials and equipment delivered and suitably stored at the site for subsequent incorporation in the completed construction, or, if approved in advance by the Owner, suitably stored off the site at a location agreed upon in writing and insured as specified.
- .3 Completed work shall be determined by multiplying the percentage completion of each portion of the Work by the share of the Contract Sum allocated to that portion of the Work in the schedule of values.

§ 5.1.6.2 The amount of each progress payment shall then be reduced by:

- .1 The aggregate of any amounts previously paid by the Owner;
- .2 The amount, if any, for Work that remains uncorrected and for which the Architect has previously withheld a Certificate for Payment as provided in Article 9 of AIA Document A201-2017;
- .3 Any amount for which the Contractor does not intend to pay a Subcontractor or material supplier, unless the Work has been performed by others the Contractor intends to pay;
- .4 For Work performed or defects discovered since the last payment application, any amount for which the Architect may withhold payment, or nullify a Certificate of Payment in whole or in part, as provided in Article 9 of AIA Document A201-2017; and
- .5 Retainage withheld pursuant to Section 5.1.7.

§ 5.1.6.3 Any Progress Payment shall include partial release of liens for material and labor for previous application for payment amount approved and paid. The DBE Utilization Report shall be included with the pay application.

### § 5.1.7 Retainage

§ 5.1.7.1 For each progress payment made prior to Substantial Completion of the Work, the Owner may withhold the following amount, as retainage, from the payment otherwise due:

*(Insert a percentage or amount to be withheld as retainage from each Application for Payment. The amount of retainage may be limited by governing law.)*

«Five percent (5%) of the first fifty percent (50%) of the completed work and after fifty percent (50%) completion has been accomplished, no further retainage shall be held from the original Contract Sum. Increases in the contract sum by Change Order shall also be subject to retainage.»

§ 5.1.7.1.1 The following items are not subject to retainage:

*(Insert any items not subject to the withholding of retainage, such as general conditions, insurance, etc.)*

«N/A»

§ 5.1.7.2 Except as set forth in this Section 5.1.7.3, upon Substantial Completion of the Work, the Contractor may submit an Application for Payment that includes the retainage withheld from prior Applications for Payment

pursuant to this Section 5.1.7. The Application for Payment submitted at Substantial Completion shall not include retainage as follows:

*(Insert any other conditions for release of retainage upon Substantial Completion.)*

«The net amount of the Retainage shall be equal to two and one half percent (2.5%) of total Contract Sum, as increased or decreased by Change Order. »

§ 5.1.8 If final completion of the Work is materially delayed through no fault of the Contractor, the Owner shall pay the Contractor any additional amounts in accordance with Article 9 of AIA Document A201–2017.

§ 5.1.9 Except with the Owner’s prior approval, the Contractor shall not make advance payments to suppliers for materials or equipment which have not been delivered and stored at the site.

## § 5.2 Final Payment

§ 5.2.1 Final monthly progress payment, constituting the entire unpaid balance of the Contract Sum, less retainage, shall be made by the Owner to the Contractor when

- .1 the Contractor has fully performed the Contract except for the Contractor’s responsibility to correct Work as provided in Article 12 of AIA Document A201 (including Owner’s then-current modifications which may be obtained from the Owner or, alternatively, a copy of which is incorporated in the Project Manual and incorporated by reference herein as a part thereof), and to satisfy other requirements, if any, which extend beyond final payment; and
- .2 a Certificate of Substantial Completion has been issued by the Architect/Owner and the project accepted.

§ 5.2.2 The Owner’s final payment to the Contractor of retainage shall be made as follows:

« The final two and one half percent (2.5%) of the total Contract Sum retained will not be paid until proof of publication is submitted and all written claims paid in full. Contractor to submit the following:

- Contractor’s Affidavit of Payment of Debts and Claims (AIA form G706, included in contract documents) with
  - a.) Contractor’s Release or Waiver of Liens
  - b.) Releases or Waivers of Liens from Subcontractors and Material and Equipment Suppliers;
- Contractor’s Affidavit of Release of Liens (AIA form G706A, included in contract documents);
- Consent of Surety, if any, to final payment (AIA form G707, included in contract documents);
- Any additional close out requirements per the contract documents; and
- Notarized Affidavit of Notice of Completion advertisement from publisher.

Contractor shall provide proof of publication of Notice of Completion in a local newspaper once per week for four (4) consecutive weeks, as required in the Title 39, Section 39-1-1, Subsection (f), of the Code of Alabama quoted below. “The Contractor shall, immediately after the completion of the contract, give notice of Completion by an advertisement in a newspaper of general circulation published within the city or county in which the work has been done, for a period of four (4) consecutive weeks. A final settlement shall not be made upon the contract until the expiration of thirty (30) days after the completion of the notice. Proof of publication of the notice shall be made by the contractor to the authority by whom the contract was made by affidavit of the publisher and a printed copy of the notice published. If no newspaper is published in the county in which the work is done, the notice may be given by the contract.” (Acts 1927, No. 39, 9.37; Acts 1935, No. 39, 9. 70; Code 1940, T. 50, Section 16; Acts 1983, No. 83-737, 9.1203; Acts 1989, No. 89-650m 9. 1284, Section 1; Acts 1994, No. 94-207, p. 270, Section 1; Acts 1997, No. 97-225, p. 348, Section 1.)

The Notice of Completion shall read as follows:

STATE OF ALABAMA  
COUNTY OF MOBILE  
NOTICE OF COMPLETION

In accordance with Chapter I, Title 39, Code of Alabama, 1975, NOTICE IS HEREBY given that <contractor name> has completed the contract for PW-062-24, Pinehill Recycling Center, 308 Pinehill Drive, Mobile, Alabama 36606. All persons having any claims for labor, material or otherwise in connection with this project should immediately notify the Architectural Engineering Department, City of Mobile, P. O. Box 1827, Mobile, Alabama 36633-1827.

Publication of the Notice of Completion shall not begin until the Project has been accepted as Substantially Complete by the City of Mobile.

»

## ARTICLE 6 DISPUTE RESOLUTION

### § 6.1 Initial Decision Maker

The Engineer will serve as the Initial Decision Maker pursuant to Article 15 of AIA Document A201, unless the parties appoint below another individual, not a party to this Agreement, to serve as the Initial Decision Maker.

*(If the parties mutually agree, insert the name, address and other contact information of the Initial Decision Maker, if other than the Architect.)*

«N/A »

### § 6.2 Binding Dispute Resolution

For any Claim, the method of binding dispute resolution shall be as follows:

*(Check the appropriate box.)*

[  ] Litigation in a court of competent jurisdiction

### § 6.3 Governing Law and Venue

This Agreement shall be governed by the laws of the State of Alabama, and the appropriate venue of any actions arising out of this Agreement shall be a court of proper jurisdiction in Mobile, Alabama.

## ARTICLE 7 TERMINATION OR SUSPENSION

§ 7.1 The Contract may be terminated by the Owner or the Contractor as provided in Article 14 of AIA Document A201, General Conditions of the Contract for Construction, including Owner's then-current modifications, a copy of which is incorporated in the contract documents and incorporated by reference herein as a part thereof.

§ 7.2 The Work may be suspended by the Owner as provided in Article 14 of AIA Document A201, General Conditions of the Contract for Construction, including Owner's then-current modifications, a copy of which is incorporated in the contract documents and incorporated by reference herein as a part thereof.

## ARTICLE 8 MISCELLANEOUS PROVISIONS

§ 8.1 Where reference is made in this Agreement to a provision of AIA Document A201 or another Contract Document, the reference refers to that provision as amended or supplemented by other provisions of the Contract Documents. A copy of such amended, revised or supplemental provision is incorporated in the contract documents and hereby incorporated by reference herein as a part thereof.

§ 8.2 The Owner's representative:

*(Name, address, email address, and other information)*

«Director, REAM»

«P.O. Box 1827»

«Mobile, Alabama 36633-1827 »

§ 8.3 The Contractor's representative:

*(Name, address, email address, and other information)*

« name »

« address »

« email »

« other »

§ 8.4 Neither the Owner's nor the Contractor's representative shall be changed without ten (10) days' prior notice to the other party.

## § 8.5 Insurance and Bonds

### § 8.5.1 The Owner and the Contractor shall purchase and maintain insurance as set forth below:

The Contractor shall purchase and maintain from a company or companies lawfully authorized to do business in the jurisdiction in which the Project is located such insurance as will protect the Contractor from claims set forth below which may arise out of or result from the Contractor's operations be by the Contractor or by a Subcontractor or by anyone directly or indirectly employed by any of them, or by anyone for whose acts any of them may be liable:

- .1 Claims under workers' compensation, disability benefit and other similar employee benefit acts that are applicable to the Work to be performed;
- .2 Claims for damages because of bodily injury, occupational sickness or disease, or death of the Contractor's employees;
- .3 Claims for damages because of bodily injury, sickness or disease, or death of any person other than the Contractor's employees;
- .4 Claims for damages insured by usual personal injury liability coverage;
- .5 Claims for damages, because of injury to or destruction of tangible property, including loss of use resulting therefrom;
- .6 Claims for damages because of bodily injury, death of a person or property damage arising out of ownership, maintenance or use of a motor vehicle;
- .7 Claims for bodily injury or property damage arising out of completed operations; and
- .8 Claims involving contractual liability insurance applicable to the Contractor's obligations under Section 3.18 of the General Conditions of the Contract for Construction.

The Contractor shall take out and maintain during the life of the Contract no less than the following amounts of insurance with the City of Mobile named as an additional insured. Contractor shall submit a Certificate of Insurance. Insurance companies listed as the "Companies Affording Coverage" shall be authorized by the Secretary of the State of Alabama. Insurance produced out of the State of Alabama must be signed or counter signed by a licensed Agent of Alabama, with the Agent's name, address and telephone number typed or printed on the face of the Certificate of Insurance.

- .1 Workmen's Compensation Insurance: - Statutory-amount and coverage as required by all applicable laws, rules or regulations of the State of Alabama and the United States of America, Including the U. S. Longshore and Harbor Workers Act and the Jones Act, if applicable.
- .2 Employee's Liability Insurance shall be provided for limits of liability not less than:
  - A. Bodily Injury by Accident \$1,000,000 each accident
  - B. Bodily Injury by Disease \$1,000,000 each employee
  - C. Bodily Injury by Disease \$1,000,000 each policy
- .3 United States Longshoreman's Harbor Worker's Act.
- .4 Jones Act Coverage (if applicable) placed either in the Workers Compensation or through the Marine General Liability.
- .5 The Contractor shall provide Broad Form (commonly termed Comprehensive) General Liability Insurance (including premises-product-completed operations, independent contractors, and blanket contractual liability), specifically covering the obligations assumed by the Contractor for limits of liability not less than:
  - A. Bodily Injury \$1,000,000 each person  
\$1,000,000 each occurrence
  - B. Property Damage \$1,000,000 each occurrence; or
  - C. Bodily Injury and Property Damage \$1,000,000 combined single limit
  - D. Damage to Rented Premises \$1,000,000 each occurrence

- .6 Such comprehensive policy shall include the following:
- A. All liability of the Contractor, for the Contractor’s Direct Operations.
  - B. Subcontractor’s Operations.
  - C. Completed Operations Cover, thereby meaning any loss which shall occur after the contract has been completed, but which can be traced back to the Contract.
  - D. General Aggregate Limit of \$2,000,000 shall apply on a "Per Project" Basis.
  - E. Contractual Liability, meaning thereby; any risk assumed by the Contractor under Hold Harmless Agreements or any other assumption of liability, but specifically items 11.1.1.8.3G herein below
  - F. Broad Form Property Damage Coverage, including Completed Operations.
  - G. Personal Injury Liability, with employee’s exclusions removed.
  - H. Explosion and Collapse Hazard:  
    - Included or  Not Applicable.
  - I. Underground Hazard:  
    - Included or  Not Applicable.
  - J. Marine General Liability shall include Premises and Operations, Personal and Advertising Injury, Products and Completed Operations, Protection and Indemnity including vessel and crew (if applicable).
  - K. Deletion of watercraft exclusion with respect to non-owned vessels and contractual Liability for watercraft exposure not covered by Protection and Indemnity policy.
  - L. The Marine General Liability policy must include an endorsement to cover “Sudden And Accidental Pollution.”
- .7 The Contractor shall carry for himself and shall require that all Subcontractors and all Owners of Automobiles or trucks rented or hired on the contract carry, until the Contracts is completed, Comprehensive Automobile Liability Coverage for Bodily Injury and property. Damage for any auto in amounts not less than the minimum amounts as indicated. The Contractor and Subcontractor shall also carry for themselves insurance for all non-owned and hired automobile at the limits of liability as indicated below:
- |    |                                      |  |
|----|--------------------------------------|--|
| A. | Bodily Injury                        | \$1,000,000 each person<br>\$1,000,000 each occurrence |
| B. | Property damage                      | \$1,000,000 each occurrence; or,                       |
| C. | Bodily Injury and<br>Property damage | \$1,000,000 combined single limit                      |
- .8 Umbrella/Excess Liability: <\$2,000,000 combined single limit each occurrence for bodily injury and/or property damage> “confirm with PM”
- .9 Builder’s Risk Coverage (Property Insurance): The Contractor shall carry for the Owner, himself, and all Subcontractors a Builder’s Risk Policy to cover the full amount of the Contract during construction, fabrication or erection of any equipment.
- A. The Contractor shall purchase and maintain, in a company or companies lawfully authorized to do business in the jurisdiction in which the Project is located, property insurance written on a builder’s risk “all-risk” or equivalent policy form in the amount of the initial Contract Sum, plus value of subsequent Contract Modifications and cost of materials supplied or installed by others, comprising total value for the entire Project at the site on a replacement cost basis. Such property insurance shall be maintained, unless otherwise provided in the Contract Documents or otherwise agreed in writing by all persons and entities who are beneficiaries of such insurance, until final payment has been made as provided in Section 9.10 or until no person or entity other than the Owner has an insurable interest in the

property, whichever is later. This insurance shall include interests of the Owner, the Contractor, Subcontractors, Sub-subcontractors, and the Design Professionals in the Project.

- B. Property insurance shall be on an “all-risk” or equivalent policy form and shall include, without limitation, insurance against the perils of fire (with extended coverage) and physical loss or damage including, without duplication of coverage, theft, vandalism, malicious mischief, collapse, windstorm, falsework, testing and startup, temporary buildings and debris removal including demolition occasioned by enforcement of any applicable legal requirements, and shall cover reasonable compensation for Architect’s and Contractor’s services and expenses required as a result of such insured loss.
  - C. If the property insurance requires deductibles, the Contractor shall pay costs not covered because of such deductibles. Deductibles shall be limited to a maximum of \$2,500.00 unless the loss is caused by windstorm; then deductible shall be a maximum of three percent (3%) of the insured value.
  - D. This property insurance shall cover the full value of equipment, material, and other portions of the Work stored off the site, and also portions of the Work in transit. There shall be no limits on the value of loss per occurrence.
  - E. A named storm endorsement is required. The deductible shall be a maximum of three percent (3%) of the insured value.
- .10 A Surety authorized to do business in the State of Alabama shall furnish the required Insurance.
  - .11 The standard ACORD™ format shall be provided. The ACORD™ Certificate must be signed or countersigned by a Licensed Resident Agent of the State of Alabama and the agent’s name, address and telephone number must appear on the face of the certificate.
  - .12 The Surety must have a minimum rating of A/Class VI as reported in the latest issue of Best’s Key Rating Guide Property-Casualty, published by Alfred M. Best Company, Inc. if the bid price exceeds \$50,000.00.
  - .13 “In Rem” endorsement.

The insurance shall be written for not less than limits of liability specified in the Contract Documents or required by law, whichever coverage is greater. Coverages, whether written on an occurrence or claims-made basis, shall be maintained without interruption from the date of commencement of the Work until the date of final payment and termination of any coverage required to be maintained after final payment, and, with respect to the Contractor’s completed operations coverage, until the expiration of the period for correction of Work or for such other period for maintenance of completed operations coverage as specified in the Contract Documents.

Certificates of insurance acceptable to the Owner shall be filed with the Owner within ten (10) calendar days from date of issuance of contract forms for execution. Contractor shall deliver to the City of Mobile, certificates of insurance certifying the existence and limits of the insurance coverages along with separate policy endorsements. Contractor shall also be responsible for delivering policy renewal certificates to the City of Mobile, and thereafter upon renewal or replacement of each required policy of insurance. These certificates and the insurance policies shall contain a provision that coverages afforded under the policies will not be cancelled subject to non-renewal nor material change, or allowed to expire without at least thirty (30) days’ (except ten (10) days from non-payment) prior written notice has been given to the Owner. An additional certificate evidencing continuation of liability coverage, including coverage for completed operations, shall be submitted with the final Application for Payment and thereafter upon renewal or replacement of such coverage until the expiration of the time. Information concerning reduction of coverage on account of revised limits or claims paid under the General Aggregate, or both, shall be furnished by the Contractor with reasonable promptness.



All policies of insurance, except worker's compensation, shall be endorsed to provide that all such insurances are primary and non-contributing with any other insurance maintained by the City of Mobile and endorsed to waive rights of subrogation in favor of the City of Mobile.

The Contractor shall cause the commercial liability coverage required by the Contract Documents to include (1) the Owner, the Architect and the Architect's Consultants as additional insureds for claims caused in whole or in part by the Contractor's negligent acts or omissions during the Contractor's operations; and (2) the Owner as an additional insured for claims caused in whole or in part by the Contractor's negligent acts or omissions during the Contractor's completed operations.

**§ 8.5.2** The Contractor shall provide bonds as set forth below:

Contractor shall furnish bonds covering faithful performance of the Contract and payment of obligations arising thereunder.

Upon the request of any person or entity appearing to be a potential beneficiary of bonds covering payment of obligations arising under the Contract, the Contractor shall promptly furnish a copy of the bonds or shall authorize a copy to be furnished.

The Labor and Material Payment Bond and the Performance Bond shall each be for one hundred percent (100%) of the Contract Sum.

1. Bond shall be submitted with the executed agreement on provided form(s).
2. Power of Attorney is required for both bonds.
3. A Surety authorized to do business in the State of Alabama shall furnish both bonds.
4. A Surety licensed to do business in the State of Alabama must execute the bonds.
5. The Surety must have a minimum rating of A/Class VI as reported in the latest issue of Best's Key Rating Guide Property-Casualty, published by Alfred M. Best Company, Inc., if the bid price exceeds \$50,000.00.
6. The Surety company shall be required to execute AIA Document G-707, "Consent of Surety to Final Payment" prior to Final Payment being made to the Contractor.

**§ 8.6** Indemnification:

Contractor shall indemnify, defend and hold harmless City and its officers, elected officials, agents, representatives, and employees in respect of any and all claims, injuries, losses, diminution in value, damages, liabilities, whether or not currently due, and related expenses (including without limitation, settlement costs and any legal or other expenses for investigating or defending any actions or threatened actions) arising from or in connection with Contractor's performance under this agreement, including but not limited to, environmental laws, regulations, orders and decrees of whatever character or nature and damage or injury to persons or property. Contractor hereby confirms and agrees that Contractor is not a 'design professional' as defined in Alabama Act 2021-318, and not required to carry professional liability insurance for the performance or obligations of this contract.

**§ 8.7** Other provisions:

« Contractor shall provide a minimum one (1) years warranty from the date of substantial completion of all Labor and Materials for the Work covered by this contract, unless otherwise specified. Labor and Material warranties required by other sections of the construction document shall not conflict with this provision. The most stringent warranty provision shall apply. »

**§ 8.8** Force Majeure:

In the event that either party hereto shall be delayed or hindered in or prevented from the performance of any act required hereunder by reason of strikes, lockouts, labor troubles, inability to procure materials, failure of power, restrictive governmental laws or regulations, riots, insurrection, war, Act of God, or other reason of a like nature not the fault of the party delayed in performing work or doing acts required under the terms of this Agreement, then

performance of such act shall be excused for the period of the delay and the period for the performance of any such act shall be extended for a period equivalent to the period of such delay.

**ARTICLE 9 ENUMERATION OF CONTRACT DOCUMENTS**

§ 9.1 This Agreement is comprised of the following documents:

- .1 AIA Document A101™–2017, Standard Form of Agreement Between Owner and Contractor
- .2 AIA Document A201, General Conditions of the Contract for Construction, including Owner’s then-current modifications, a copy of which is incorporated in the contract documents and incorporated by reference herein as a part thereof.

.3 Drawings

| Number      | Title                                | Date      |
|-------------|--------------------------------------|-----------|
| Title Sheet | Title Sheet                          | 11/1/2024 |
| C101        | Existing Site & Best Management Plan | 11/1/2024 |
| C102        | Project Scope                        | 11/1/2024 |
| C301        | Concrete Pad                         | 11/1/2024 |
| C501        | Miscellaneous Details                | 11/1/2024 |
| C502        | Environmental Control Plan & Details | 11/1/2024 |
| C503        | Supplemental Environmental Controls  | 11/1/2024 |

.4 Specifications

| Section        | Title                               | Date      |
|----------------|-------------------------------------|-----------|
| Section 01010  | Summary of Work                     | 1/30/2025 |
| Section 01210  | Allowances                          | 1/30/2025 |
| Section 01220  | Unit Prices                         | 1/30/2025 |
| Section 01310  | Project Management & Co-ordination  | 1/30/2025 |
| Section 01320  | Construction Progress Documentation | 1/30/2025 |
| Section 01330  | Submittal Procedures                | 1/30/2025 |
| Section 01700  | Execution Requirements              | 1/30/2025 |
| Section 01731  | Cutting and Patching                | 1/30/2025 |
| Section 01770  | Close out Procedures                | 1/30/2025 |
| Section 017839 | Project Record Documents            | 1/30/2025 |
| Section 017823 | Operation and Maintenance Data      | 1/30/2025 |

.5 Addenda, if any:

| Number | Date |
|--------|------|
|        |      |

Portions of Addenda relating to bidding or proposal requirements are not part of the Contract Documents unless the bidding or proposal requirements are also enumerated in this Article 9.

.6 Other Exhibits:

§ 9.2

Supplementary and other Conditions of the Contract:

| Document | Title | Date | Pages |
|----------|-------|------|-------|
| N/A      |       |      |       |

§ 9.2.1 Other documents, if any, listed below:

*(List here any additional documents that are intended to form part of the Contract Documents. AIA Document A201™–2017 provides that the advertisement or invitation to bid, Instructions to Bidders, sample forms, the Contractor’s bid or proposal, portions of Addenda relating to bidding or proposal requirements, and other information furnished by the Owner in anticipation of receiving bids or*

proposals, are not part of the Contract Documents unless enumerated in this Agreement. Any such documents should be listed here only if intended to be part of the Contract Documents.)

#### **BIDDING AND CONTRACT REQUIREMENTS**

|               |  |
|---------------|--|
| Section 00100 | Invitation to Bid  |
| Section 00200 | Instructions to Bidders-AIA Document A701-2018   |
| Section 00300 | Supplementary Instructions to Bidders  |
| Section 00400 | Bid Form   |
|               | Accounting of Sales Tax Form C-3A  |
|               | Office of Supplier Diversity Subcontracting and Major Supplier Plan  |
| Section 00500 | Standard Form of Agreement Between Owner and Contractor<br>AIA Document A101   |
| Section 00600 | Bonds, Certificates and Affidavits   |
|               | Performance Bond   |
|               | Labor and Material Payment Bond  |
|               | E-Verify Documentation (Sample)  |
|               | Application and Certificate for Payment-AIA Document G702and G703<br>with DBE Utilization Report                       |
|               | Certificate of Substantial Completion-AIA Document G704  |
|               | Contractor's Affidavit of Payment of Debts and Claims-<br>AIA Document G706  |
|               | Contractor's Affidavit of Release of Liens-AIA Document G706A  |
|               | Consent of Surety to Final Payment-AIA Document G707   |
|               | Request for Taxpayer Identification Number and Certification W9 Tax<br>Form and City of Mobile Vendor Information Form |
| Section 00700 | General Conditions of the Contract for Construction-<br>AIA Document A201»   |

**§ 9.2.2** Best Management Practices (BMPs): The Contractor shall be responsible for providing, implementing and maintaining BMPs for sediment and erosion control in full compliance with all applicable Local, State and Federal Codes and Ordinances throughout the contract period. All Work shall be in accordance with the Clean Water Act; the Alabama Water Pollution Control Act; the current version of the Alabama Handbook for Erosion Control, Sediment Control Storm water Management on Construction sites and Urban Areas; and the current version of the Mobile, Alabama City Code Chapter 17 Storm water Management and Flood Control. All Wastewater with oils, grease, paint, mortar, etc., shall be properly contained and disposed of.

**§ 9.2.3** Contractor shall comply with all Federal, State and local laws concerning nondiscrimination, including but not limited to City of Mobile Ordinance No. 14-034 which requires, *inter alia*, that all contractors performing work for the City of Mobile not discriminate on the basis of race, creed, color, national origin or disability, require that all subcontractors they engage do the same, and make every reasonable effort to assure that fifteen percent of the work performed under contract be awarded to socially and economically disadvantaged individuals and business entities.

**§ 9.2.4** By signing this contract, the contracting parties affirm, for the duration of the agreement, that they will not violate federal immigration law or knowingly employ, hire for employment, or continue to employ an unauthorized alien within the State of Alabama. Furthermore, a contracting party found to be in violation of this provision shall be deemed in breach of the agreement and shall be responsible for all damages resulting therefrom.

**§ 9.2.5** Public Contracts with Entities Engaging in certain Boycott Activities:  
By signing this contract, the Contractor further represents and agrees that it is not currently engaged in, nor will it engage in, any boycott of a person or entity based in or doing business with a jurisdiction with which the State of Alabama can enjoy open trade.

**§ 9.2.6** Severability Clause:  
In case any one or more of the provisions contained in this Agreement shall for any reason be held to be invalid, illegal or unenforceable in any respect, such invalidity, illegality or unenforceability shall not affect any other provisions of this Agreement, but this Agreement shall be construed as if such invalid or illegal

or unenforceable provision had never been contained herein. Upon such determination that any term or other provision is invalid, illegal or unenforceable, the court or other tribunal making such determination is authorized and instructed to modify this Agreement so as to effect the original intent of the parties as closely as possible so that the transactions and agreements contemplated herein are consummated as originally contemplated to the fullest extent possible.

**§ 9.2.7 Non-Agency Clause:**

Contractor, in the performance of its operations and obligations hereunder, shall not be deemed to be an agent of City but shall be deemed to be an independent Contractor in every respect and shall take all steps at its own expense, as City may from time to time request, to indicate that it is an independent Contractor. City does not and will not assume any responsibility for the means by which or the manner in which the services by Contractor provided for herein are performed, but on the contrary, Contractor shall be wholly responsible therefore.

**REMAINDER OF PAGE INTENTIONALLY LEFT BLANK**



This Agreement entered into as of the day and year first written above.

Owner: City of Mobile

Legal Name of Party to Contract:  
Contractor: <name of contractor>

\_\_\_\_\_  
**OWNER** *(Signature)*

\_\_\_\_\_  
**CONTRACTOR** *(By Signature)*

\_\_\_\_\_  
William S. Stimpson, Mayor  
*(Printed name and title)*

\_\_\_\_\_  
<Name of person signing form>  
*(Printed name and title)*

ATTEST:

\_\_\_\_\_  
City Clerk

STATE OF \_\_\_\_\_  
COUNTY OF \_\_\_\_\_

Before me, the undersigned a Notary Public in and for said County and State, personally appeared <Individual NAME> as <Title within Company> of <Company Legal Name> and after being duly sworn, did depose and say that he, as such officer and with full authority, signed the above and foregoing voluntarily as the act of said corporation on the day the same bears date.  
Sworn to and subscribed for me this \_\_\_\_\_ day of \_\_\_\_\_, 20\_\_\_\_\_.

\_\_\_\_\_  
NOTARY PUBLIC  
My Commission Expires: \_\_\_\_\_



**SECTION 00600**  
**BONDS, CERTIFICATES AND AFFIDAVITS**

**PART 1 GENERAL**

This section includes the Bond Forms and Certificates that are to be used on this Project. No other forms will be accepted. Forms may be obtained from the Architectural Engineering Department, City of Mobile, telephone number 251-208-7454.

1.1 FORMS

- A. PERFORMANCE BOND. Owner's modified Performance Bond form.
- B. LABOR AND MATERIAL PAYMENT BOND. Owner's modified Payment Bond form.
- C. E-Verify Documentation (Sample)
- D. APPLICATION AND CERTIFICATION FOR PAYMENT - AIA Document G702 and AIA Document G703 and DBE Utilization Report
- E. CERTIFICATE of SUBSTANTIAL COMPLETION – AIA Document G704-2017
- F. CONTRACTOR'S AFFIDAVIT OF PAYMENT OF DEBTS AND CLAIMS - AIA Document G706
- G. CONTRACTOR'S AFFIDAVIT OF RELEASE OF LIENS - AIA Document G706A.
- H. CONSENT OF SURETY TO FINAL PAYMENT - AIA Document G707
- I. Request for Taxpayer Identification Number and Certification, W-9 Form, and City of Mobile Vendor Information Form

# PERFORMANCE BOND

Any singular reference to Contractor, Surety, Owner or other Party shall be considered plural where applicable.

**KNOW ALL MEN BY THESE PRESENTS:** That the Contractor, \_\_\_\_\_, \_\_\_\_\_, hereinafter called the Principal, and \_\_\_\_\_, hereinafter called the Surety, are held and firmly bound unto the **City of Mobile, P. O. Box 1827, Mobile, AL 36633**, hereinafter called the Owner, in the penal sum of \_\_\_\_\_ and xx/100 Dollars (\$\_\_\_\_\_.\_\_) for payment of which we bind ourselves, our heirs, executors, administrators, successors, and assigns for the faithful performance of a certain written Contract dated the \_\_\_\_ day of \_\_\_\_\_, 2025 entered into between the Principal and the City of Mobile for furnishing all labor, material, equipment and insurance and performing all Work required to properly complete Pinehill Recycling Center, 308 Pinehill Drive, Mobile, Alabama 36606, a copy of which said Contract is incorporated herein by reference and is made a part hereof as if fully copied herein.

**NOW, THEREFORE**, the condition of this obligation is such that if the Principal shall faithfully perform the terms and conditions of the Contract in all respects on its part and shall fully pay all obligations incurred in connection with the performance of such Contract on account of labor and materials used in connection therewith, and all such other obligations of every form, nature and character, and shall save harmless the Owner from all and any liability of every nature, kind and character which may be incurred in connection with the performance or fulfillment of such Contract or other such and liability resulting from negligence or otherwise on the part of such Principal and further save harmless the Owner from all cost and damage which may be suffered by reason of the failure to fully and completely perform said contract and shall fully reimburse and repay the Owner for all expenditures of every kind, character, and description which may be incurred by the Owner in making good any and every default which may exist on the part of the Principal in connection with the performance of said Contract; and further that the Principal shall pay all lawful claims of all persons, firms, partnerships, or corporations for all labor performed and material furnished in connection with the performance of the Contract, and that the failure to do so with such persons, firms, partnerships or corporations shall give them a direct obligation; and provided, however, that no suit, action, or proceedings by reason of any default whatever shall be brought on this bond after two years from the date on which the final payment on the Contract falls due, and provided, further, that if any alterations or additions which may be made under the Contract, or in the work to be done under it, or the giving by the Owner of any extensions of time for the performance of the Contract or any other forbearance being expressly waived. This obligation shall remain in full force and effect until the performance of all covenants, terms and conditions herein stipulated and after such performance, it shall become null and void.

In addition to any other legal mode of service, service of summons, and other process in civil actions brought in Mobile County may be had on the Contractor or the Surety on the bond by leaving a copy of the summons and complaint or other pleading or process with the Mayor of the City of Mobile which shall bind the principal Contractor and Surety to the mode of service above described and that the service shall be the same as personal service on the contractor or surety. This Bond is given pursuant to the terms of Alabama Code, Title 39-1-1, et. al., As Amended.

## EXECUTED IN FOUR (4) COUNTERPARTS.

SIGNED, SEALED AND DELIVERED this \_\_\_\_ day of \_\_\_\_\_, 2025.

**CONTRACTOR AS PRINCIPAL**

Company: \_\_\_\_\_  
(Corporate Seal)

By: \_\_\_\_\_  
(Signature)

Name and Title: \_\_\_\_\_

**SURETY**

Company: \_\_\_\_\_  
(Corporate Seal)

By: \_\_\_\_\_  
(Signature)

Name and Title: \_\_\_\_\_

Resident Agent: \_\_\_\_\_  
(Signature)

Name and Title: \_\_\_\_\_  
Company Name: \_\_\_\_\_  
Address: \_\_\_\_\_  
Phone and Fax: \_\_\_\_\_

Owner's Representative: Cassie Boatwright  
REAM Director  
PO Box 1827  
Mobile, AL 36633  
251-208-7454

# LABOR AND MATERIAL PAYMENT BOND

Any singular reference to Contractor, Surety, Owner or other Party shall be considered plural where applicable.

**KNOW ALL MEN BY THESE PRESENTS:** That the Contractor, \_\_\_\_\_, \_\_\_\_\_, \_\_\_\_\_, as Principal, and \_\_\_\_\_, \_\_\_\_\_, \_\_\_\_\_, as Surety, are held and firmly bound unto the **City of Mobile, P. O. Box 1827, Mobile, AL 36633** (hereinafter called the "Obligee") in the penal sum of \_\_\_\_\_ and xx/100 Dollars (\$\_\_\_\_\_) lawful money of the United States, for the payment of which sum well and truly to be made we bind ourselves, our heirs, personal representatives, successors, and assigns, jointly and severally, firmly by these presents.

**WHEREAS**, said Principal has entered into a certain Contract with said Obligee, dated the \_\_\_\_ day of \_\_\_\_\_, 2024 (hereinafter called the "Contract") for furnishing all labor, material, equipment and insurance and perform all work required to properly complete Pinehill Recycling Center, 308 Pinehill Drive, Mobile, Alabama 36606, which, **THEREFORE, THE CONDITION OF THIS OBLIGATION IS SUCH** that if said Principal and all subcontractors to whom any portion of work provided for in said Contract is sublet and all assignees of said Principal and of such subcontractors shall promptly make payments to all persons supplying him or them with labor, materials or supplies for or in the prosecution of the work provided for in such Contract, or in any amendment or extension of or additions to said Contract, and for the payment of reasonable attorney's fees, incurred by the claimant or claimants in suits on each bond, then the above obligations shall be void; otherwise to remain in full force and effect.

**PROVIDED**, however, that this bond is subject to the following conditions and limitations.

- (a) Any person, firm or corporation that has furnished labor, materials or supplies for or in the prosecution of the work provided for in said contract shall have a direct right of action against the Principal and Surety on this bond, which right of action shall be asserted in a proceeding instituted in the County in which the work provided for in said Contract is to be performed or in any county in which said Principal and Surety does business. Such right of action shall be asserted in a proceeding instituted in the name of the claimant or claimants for his or their use and benefit against said Principal and Surety or either of them (but not later than one year after the final settlement of said Contract) in which action such claim or claims shall be adjudicated and judgment rendered thereon.
- (b) The Principal and Surety hereby designate and appoint \_\_\_\_\_ **Attorney-In-Fact**, as the agent of each of them to receive and accept service of process or other pleading issued or filed in any proceeding instituted on this bond and hereby consent that such service shall be the same as personal service on the Principal and/or Surety. In addition to any other legal mode of service, service of summons, and other process in civil actions brought in Mobile County may be had on the Contractor or the Surety on the bond by leaving a copy of the summons and complaint or other pleading or process with the Mayor of the City of Mobile which shall bind the principal Contractor and Surety to the mode of service above described and that the service shall be the same as personal service on the contractor or surety.
- (c) The Surety shall not be liable hereunder for damage or compensation recoverable under any Workmen's Compensation or Employer's Liability Statute.
- (d) In no event shall the Surety be liable for a greater sum than the penalty of this bond, or subject to any suit, action or proceeding thereon that is instituted later than two years after the final settlement of said Contract.
- (e) This bond is given pursuant to the terms of Alabama Code, Title 39-1-1, et. al., As Amended.

## EXECUTED IN FOUR (4) COUNTERPARTS.

SIGNED, SEALED AND DELIVERED this \_\_\_\_ day of \_\_\_\_\_, 2025

**CONTRACTOR AS PRINCIPAL**  
Company: \_\_\_\_\_  
(Corporate Seal)

**SURETY**  
Company: \_\_\_\_\_  
(Corporate Seal)

By: \_\_\_\_\_  
(Signature)

By: \_\_\_\_\_  
(Signature)

Name and Title: \_\_\_\_\_  
\_\_\_\_\_

Name and Title: \_\_\_\_\_  
\_\_\_\_\_

Resident Agent: \_\_\_\_\_  
(Signature)

Name and Title: \_\_\_\_\_  
Company Name: \_\_\_\_\_  
Address: \_\_\_\_\_  
\_\_\_\_\_  
Phone and Fax: \_\_\_\_\_

Owner's Representative: Cassie Boatwright  
REAM Director  
PO Box 1827  
Mobile, AL 36633  
251-208-7454



Company ID Number:

Approved by:

|   |       |
|---|-------|
| Employer                                  |       |
| Name (Please Type or Print)               |       |
| Signature                                 | Date  |
| Department of Homeland Security, Division |       |
| Name (Please Type or Print)               | Title |
| Signature                                 | Date  |

**SAMPLE**

Company ID Number:

| Information Required for the E-Verify Program       |  |
|---|--|
| Information relating to your Company:               |  |
| Company Name  |  |
| Company Facility Address                            |  |
| Company Alternate Address                           |  |
| County or Parish                                    |  |
| Employer Identification Number                      |  |
| North American Industry Classification Systems Code |  |
| Parent Company                                      |  |
| Number of Employees                                 |  |
| Number of Sites Verified for                        |  |

**SAMPLE**

TO OWNER City of Mobile  
P. O. Box 1827  
Mobile, Alabama 36633-1827

PROJECT:

APPLICATION NO:

Distribution to:

|                          |            |
|--------------------------|------------|
| <input type="checkbox"/> | OWNER      |
| <input type="checkbox"/> | ARCHITECT  |
| <input type="checkbox"/> | CONTRACTOR |
| <input type="checkbox"/> |            |
| <input type="checkbox"/> |            |

PERIOD TO:

FROM CONTRACTOR:

VIA ARCHITECT:

PROJECT NO:

CONTRACT FOR:

CONTRACT DATE:

**CONTRACTOR'S APPLICATION FOR PAYMENT**

Application is made for payment, as shown below, in connection with the Contract. Continuation Sheet, AIA Document G703, is attached.

The undersigned Contractor certifies that to the best of the Contractor's knowledge, information and belief the Work covered by this Application for Payment has been completed in accordance with the Contract Documents, that all amounts have been paid by the Contractor for Work for which previous Certificates for Payment were issued and payments received from the Owner, and that current payment shown herein is now due.

- 1. ORIGINAL CONTRACT SUM \$ \_\_\_\_\_
- 2. Net change by Change Orders \$ \_\_\_\_\_
- 3. CONTRACT SUM TO DATE (Line 1 ± 2) \$ \_\_\_\_\_
- 4. TOTAL COMPLETED & STORED TO DATE (Column G on G703) \$ \_\_\_\_\_
- 5. RETAINAGE:
  - a. \_\_\_\_\_ % of Completed Work \$ \_\_\_\_\_  
(Column D + E on G703)
  - b. \_\_\_\_\_ % of Stored Material \$ \_\_\_\_\_  
(Column F on G703)
  - Total Retainage (Lines 5a + 5b or Total in Column I of G703) \$ \_\_\_\_\_
- 6. TOTAL EARNED LESS RETAINAGE \$ \_\_\_\_\_  
(Line 4 Less Line 5 Total)
- 7. LESS PREVIOUS CERTIFICATES FOR PAYMENT (Line 6 from prior Certificate) \$ \_\_\_\_\_
- 8. CURRENT PAYMENT DUE \$ \_\_\_\_\_
- 9. BALANCE TO FINISH, INCLUDING RETAINAGE \$ \_\_\_\_\_  
(Line 3 less Line 6)

CONTRACTOR:

By: \_\_\_\_\_ Date: \_\_\_\_\_

State of: \_\_\_\_\_ County of: \_\_\_\_\_  
Subscribed and sworn to before me this \_\_\_\_\_ day of \_\_\_\_\_  
Notary Public:  
My Commission expires: \_\_\_\_\_

**ARCHITECT'S CERTIFICATE FOR PAYMENT**

In accordance with the Contract Documents, based on on-site observations and the data comprising the application, the Architect certifies to the Owner that to the best of the Architect's knowledge, information and belief the Work has progressed as indicated, the quality of the Work is in accordance with the Contract Documents, and the Contractor is entitled to payment of the AMOUNT CERTIFIED.

AMOUNT CERTIFIED . . . . . \$ \_\_\_\_\_

*(Attach explanation if amount certified differs from the amount applied. Initial all figures on this Application and on the Continuation Sheet that are changed to conform with the amount certified.)*  
ARCHITECT:

By: \_\_\_\_\_ Date: \_\_\_\_\_

This Certificate is not negotiable. The AMOUNT CERTIFIED is payable only to the Contractor named herein. Issuance, payment and acceptance of payment are without prejudice to any rights of the Owner or Contractor under this Contract.

| CHANGE ORDER SUMMARY                               | ADDITIONS | DEDUCTIONS |
|--|-----------|------------|
| Total changes approved in previous months by Owner |           |            |
| Total approved this Month                          |           |            |
| <b>TOTALS</b>                                      |           |            |
| NET CHANGES by Change Order                        |           |            |

OFFICE OF SUPPLIER DIVERSITY

**CITY OF MOBILE**

**DBE Compliance  
DBE UTILIZATION REPORT**

**Return to Office of Supplier Diversity**  
Via email: [archnique.kidd@cityofmobile.org](mailto:archnique.kidd@cityofmobile.org)  
or  
P.O. Box 1948  
Mobile, AL 36633

|                    |                       |            |           |                             |
|--------------------|-----------------------|------------|-----------|-----------------------------|
| <b>CONTRACTOR:</b> | <b>Certified DBE:</b> | <b>YES</b> | <b>NO</b> | <b>Contract Start Date:</b> |
|--------------------|-----------------------|------------|-----------|-----------------------------|

|                     |                                   |
|---------------------|-----------------------------------|
| <b>DESCRIPTION:</b> | <b>Estimated Completion Date:</b> |
|---------------------|-----------------------------------|

|  |   |  |   |   |                    |
|--|---|--|---|---|--------------------|
| <b>This report is for the month of:</b><br><b>(CHECK ONE):</b> | <input type="checkbox"/> <b>JAN</b><br><input type="checkbox"/> <b>FEB</b><br><input type="checkbox"/> <b>MARCH</b> | <input type="checkbox"/> <b>APR</b><br><input type="checkbox"/> <b>MAY</b><br><input type="checkbox"/> <b>JUNE</b> | <input type="checkbox"/> <b>JULY</b><br><input type="checkbox"/> <b>AUG</b><br><input type="checkbox"/> <b>SEPT</b> | <input type="checkbox"/> <b>OCT</b><br><input type="checkbox"/> <b>NOV</b><br><input type="checkbox"/> <b>DEC</b> | <b>FINAL</b> _____ |
|--|---|--|---|---|--------------------|

| Original Contract Amount | Total Amount of Contract Changes<br>(change orders or amendments) | Final Contract Amount<br>(include contract changes) | Payments to Date from<br>City of Mobile | <b>OFFICE USE ONLY<br/>(Verification)</b> |
|--------------------------|---|---|---|---|
| \$                       | \$  | \$  | \$                                      |   |

**Instructions:** List all DBEs utilized on the contract, whether or not the firms were originally listed for DBE goal credit. List actual amount paid to each DBE firm. If the established Percentage is not being met, please include a narrative description of the progress being made in DBE participation.

| DBE SUBCONTRACTOR | DBE DESCRIPTION OF WORK | DBE SUBCONTRACT AMOUNT | DBE PAYMENTS THIS REPORT | PAYMENTS TO DATE | <b>OFFICE USE ONLY<br/>(Verification)</b> |
|-------------------|-------------------------|------------------------|--------------------------|------------------|---|
|                   |                         | \$                     | \$                       | \$               |   |
|                   |                         | \$                     | \$                       | \$               |   |
|                   |                         | \$                     | \$                       | \$               |   |
|                   |                         | \$                     | \$                       | \$               |   |
| <b>TOTALS</b>     |                         | \$                     | \$                       | \$               |   |

**I HEREBY CERTIFY THAT THE INFORMATION CONTAINED HEREIN IS TRUE AND CORRECT. SUPPORTING DOCUMENTATION IS ON FILE AND IS AVAILABLE FOR INSPECTION BY CITY OF MOBILE OFFICE OF SUPPLIER DIVERSITY PERSONNEL AT ANY TIME.**

PRINT NAME: \_\_\_\_\_

SIGNATURE: \_\_\_\_\_ /\_\_\_\_\_/\_\_\_\_\_  
(Title) (Date)

DBE Utilization Report



TO OWNER City of Mobile
P. O. Box 1827
Mobile, AL 36633-1827

PROJECT:

APPLICATION NO:

Distribution to:

Form with checkboxes for OWNER, ARCHITECT, CONTRACTOR and two empty boxes.

PERIOD TO:

FROM CONTRACTOR:

VIA ARCHITECT:

PROJECT NO:

CONTRACT FOR:

CONTRACT DATE:

CONTRACTOR'S APPLICATION FOR PAYMENT

Application is made for payment, as shown below, in connection with the Contract. Continuation Sheet, AIA Document G703, is attached.

The undersigned Contractor certifies that to the best of the Contractor's knowledge, application and belief the Work covered by this Application for Payment has been completed in accordance with the Contract Documents, that all amounts have been paid by the Contractor for Work for which previous Certificates for Payment were issued and payments received from the Owner, and that current payment shown herein is now due.

- 1. ORIGINAL CONTRACT SUM \$
2. Net change by Change Orders \$
3. CONTRACT SUM TO DATE (Line 1 ± 2) \$
4. TOTAL COMPLETED & STORED TO DATE (Column G on G703) \$
5. RETAINAGE:
a. % of Completed Work (Column D + E on G703) \$
b. % of Stored Material (Column F on G703) \$
Total Retainage (Lines 5a + 5b or Total in Column I of G703) \$
6. TOTAL EARNED LESS RETAINAGE (Line 4 Less Line 5 Total) \$
7. LESS PREVIOUS CERTIFICATES FOR PAYMENT (Line 6 from prior Certificate) \$
8. CURRENT PAYMENT DUE \$
9. BALANCE TO FINISH, INCLUDING RETAINAGE (Line 3 less Line 6) \$

CONTRACTOR:

By: Date:

State of: County of:
Subscribed and sworn to before me this day of
Notary Public:
My Commission expires:

ARCHITECT'S CERTIFICATE FOR PAYMENT

In accordance with the Contract Documents, based on on-site observations and the data comprising the application, the Architect certifies to the Owner that to the best of the Architect's knowledge, information and belief the Work has progressed as indicated, the quality of the Work is in accordance with the Contract Documents, and the Contractor is entitled to payment of the AMOUNT CERTIFIED.

AMOUNT CERTIFIED \$

(Attach explanation if amount certified differs from the amount applied. Initial all figures on this Application and on the Continuation Sheet that are changed to conform with the amount certified.)

ARCHITECT:

By: Date:

This Certificate is not negotiable. The AMOUNT CERTIFIED is payable only to the Contractor named herein. Issuance, payment and acceptance of payment are without prejudice to any rights of the Owner or Contractor under this Contract.

Table with 3 columns: CHANGE ORDER SUMMARY, ADDITIONS, DEDUCTIONS. Rows include Total changes approved in previous months by Owner, Total approved this Month, TOTALS, and NET CHANGES by Change Order.

# CONTINUATION SHEET

AIA DOCUMENT G703

PAGE OF PAGES

AIA Document G702, APPLICATION AND CERTIFICATION FOR PAYMENT, containing Contractor's signed certification is attached.

APPLICATION NO:  
APPLICATION DATE:

In tabulations below, amounts are stated to the nearest dollar.

PERIOD TO:

Use Column I on Contracts where variable retainage for line items may apply.

ARCHITECT'S PROJECT NO:

| A<br>ITEM<br>NO.    | B<br>DESCRIPTION OF WORK | C<br>SCHEDULED<br>VALUE | D<br>WORK COMPLETED                     |             | F<br>MATERIALS<br>PRESENTLY<br>STORED<br>(NOT IN<br>D OR E) | G  |              | H<br>BALANCE<br>TO FINISH<br>(C - G) | I<br>RETAINAGE<br>(IF VARIABLE<br>RATE) |
|---------------------|--------------------------|-------------------------|---|-------------|---|--|--------------|--------------------------------------|---|
|                     |                          |                         | FROM PREVIOUS<br>APPLICATION<br>(D + E) | THIS PERIOD |   | TOTAL<br>COMPLETED<br>AND STORED<br>TO DATE<br>(D+E+F) | %<br>(G ÷ C) |                                      |   |
|                     |                          |                         |   |             |   |  |              |                                      |   |
| <b>GRAND TOTALS</b> |                          |                         |   |             |   |  |              |                                      |   |

Users may obtain validation of this document by requesting of the license a completed AIA Document D401 - Certification of Document's Authenticity

# CONTINUATION SHEET

AIA DOCUMENT G703

PAGE OF PAGES

AIA Document G702, APPLICATION AND CERTIFICATION FOR PAYMENT, containing Contractor's signed certification is attached.

APPLICATION NO:  
APPLICATION DATE:

In tabulations below, amounts are stated to the nearest dollar.

PERIOD TO:

Use Column I on Contracts where variable retainage for line items may apply.

ARCHITECT'S PROJECT NO:

| A<br>ITEM<br>NO.    | B<br>DESCRIPTION OF WORK | C<br>SCHEDULED<br>VALUE | D<br>WORK COMPLETED                     |             | F<br>MATERIALS<br>PRESENTLY<br>STORED<br>(NOT IN<br>D OR E) | G  |              | H<br>BALANCE<br>TO FINISH<br>(C - G) | I<br>RETAINAGE<br>(IF VARIABLE<br>RATE) |
|---------------------|--------------------------|-------------------------|---|-------------|---|--|--------------|--------------------------------------|---|
|                     |                          |                         | FROM PREVIOUS<br>APPLICATION<br>(D + E) | THIS PERIOD |   | TOTAL<br>COMPLETED<br>AND STORED<br>TO DATE<br>(D+E+F) | %<br>(G ÷ C) |                                      |   |
|                     |                          |                         |   |             |   |  |              |                                      |   |
| <b>GRAND TOTALS</b> |                          |                         |   |             |   |  |              |                                      |   |

Users may obtain validation of this document by requesting of the license a completed AIA Document D401 - Certification of Document's Authenticity





# AIA Document G704™ – 2017

## Certificate of Substantial Completion

**PROJECT:** *(name and address)*

**CONTRACT INFORMATION:**

**CERTIFICATE INFORMATION:**

Contract For: Construction

Certificate Number: 001

Date:

Date:

Contract #

**OWNER:** *(name and address)*

**ARCHITECT:** *(name and address)*

**CONTRACTOR:** *(name and address)*

City of Mobile - AE Department

P. O. Box 1827

Mobile, Alabama 36633

The Work identified below has been reviewed and found, to the Architect's best knowledge, information, and belief, to be substantially complete. Substantial Completion is the stage in the progress of the Work when the Work or designated portion is sufficiently complete in accordance with the Contract Documents so that the Owner can occupy or utilize the Work for its intended use. The date of Substantial Completion of the Project or portion designated below is the date established by this Certificate.

*(Identify the Work, or portion thereof, that is substantially complete.)*

Work of the Contract for Construction.

| ARCHITECT <i>(Firm Name)</i> | SIGNATURE | PRINTED NAME AND TITLE | DATE OF SUBSTANTIAL COMPLETION |
|------------------------------|-----------|------------------------|--------------------------------|
|------------------------------|-----------|------------------------|--------------------------------|

### WARRANTIES

The date of Substantial Completion of the Project or portion designated above is also the date of commencement of applicable warranties required by the Contract Documents, except as stated below:

*(Identify warranties that do not commence on the date of Substantial Completion, if any, and indicate their date of commencement.)*

### WORK TO BE COMPLETED OR CORRECTED

A list of items to be completed or corrected is attached hereto, or transmitted as agreed upon by the parties, and identified as follows:

*(Identify the list of Work to be completed or corrected.)*

See attached punch list.

The failure to include any items on such list does not alter the responsibility of the Contractor to complete all Work in accordance with the Contract Documents. Unless otherwise agreed to in writing, the date of commencement of warranties for items on the attached list will be the date of issuance of the final Certificate of Payment or the date of final payment, whichever occurs first. The Contractor will complete or correct the Work on the list of items attached hereto within ( ) days from the above date of Substantial Completion.

Cost estimate of Work to be completed or corrected: \$

The responsibilities of the Owner and Contractor for security, maintenance, heat, utilities, damage to the Work, insurance, and other items identified below shall be as follows:

*(Note: Owner's and Contractor's legal and insurance counsel should review insurance requirements and coverage.)*

Per the Contract Documents, the Contractor shall be responsible for damages to the Work and providing all Insurance required under the AIA A101-Agreement Between Owner and the Contractor for a Stipulated Sum, Article 8.5.1, until Final Payment. The Contractor shall also be responsible for labor and materials as required to provide repairs to the work for one calendar year following the substantial completion date. The Owner shall be responsible for general security, heat, and utilities at the facility.

The Owner and Contractor hereby accept the responsibilities assigned to them in this Certificate of Substantial Completion:

|                                      |                  |  |             |
|--------------------------------------|------------------|--|-------------|
| <b>CONTRACTOR</b> <i>(Firm Name)</i> | <b>SIGNATURE</b> | <b>PRINTED NAME AND TITLE</b>                | <b>DATE</b> |
| City of Mobile                       |                  | Cynthia L. Klotz, AIA,<br>Assistant Director |             |
| <b>OWNER</b> <i>(Firm Name)</i>      | <b>SIGNATURE</b> | <b>PRINTED NAME AND TITLE</b>                | <b>DATE</b> |



**AIA**<sup>®</sup>

# Document G706™ – 1994

## Contractor's Affidavit of Payment of Debts and Claims

PROJECT: *(Name and address)*

ARCHITECT'S PROJECT NUMBER:

OWNER:

ARCHITECT:

TO OWNER: *(Name and address)*

CONTRACT FOR: General Construction

CONTRACTOR:

CONTRACT DATED:

SURETY:

OTHER:

STATE OF:

COUNTY OF:

The undersigned hereby certifies that, except as listed below, payment has been made in full and all obligations have otherwise been satisfied for all materials and equipment furnished, for all work, labor, and services performed, and for all known indebtedness and claims against the Contractor for damages arising in any manner in connection with the performance of the Contract referenced above for which the Owner or Owner's property might in any way be held responsible or encumbered.

### EXCEPTIONS:

#### SUPPORTING DOCUMENTS ATTACHED HERETO:

1. Consent of Surety to Final Payment. Whenever Surety is involved, Consent of Surety is required. AIA Document G707, Consent of Surety, may be used for this purpose

Indicate Attachment  Yes  No

CONTRACTOR: *(Name and address)*

BY:

*(Signature of authorized representative)*

*(Printed name and title)*

*The following supporting documents should be attached hereto if required by the Owner:*

1. Contractor's Release or Waiver of Liens, conditional upon receipt of final payment.
2. Separate Releases or Waivers of Liens from Subcontractors and material and equipment suppliers, to the extent required by the Owner, accompanied by a list thereof.
3. Contractor's Affidavit of Release of Liens (AIA Document G706A).

Subscribed and sworn to before me on this date:

Notary Public:

My Commission Expires:



**AIA**<sup>®</sup>

# Document G706A™ – 1994

## Contractor's Affidavit of Release of Liens

|                                     |                                       |                                      |
|-------------------------------------|---------------------------------------|--------------------------------------|
| PROJECT: <i>(Name and address)</i>  | ARCHITECT'S PROJECT NUMBER:           | OWNER: <input type="checkbox"/>      |
|                                     | CONTRACT FOR: General<br>Construction | ARCHITECT: <input type="checkbox"/>  |
| TO OWNER: <i>(Name and address)</i> | CONTRACT DATED:                       | CONTRACTOR: <input type="checkbox"/> |
|                                     |                                       | SURETY: <input type="checkbox"/>     |
|                                     |                                       | OTHER: <input type="checkbox"/>      |

STATE OF:  
COUNTY OF:

The undersigned hereby certifies that to the best of the undersigned's knowledge, information and belief, except as listed below, the Releases or Waivers of Lien attached hereto include the Contractor, all Subcontractors, all suppliers of materials and equipment, and all performers of Work, labor or services who have or may have liens or encumbrances or the right to assert liens or encumbrances against any property of the Owner arising in any manner out of the performance of the Contract referenced above.

**EXCEPTIONS:**

**SUPPORTING DOCUMENTS ATTACHED HERETO:**

1. Contractor's Release or Waiver of Liens, conditional upon receipt of final payment.
2. Separate Releases or Waivers of Liens from Subcontractors and material and equipment suppliers, to the extent required by the Owner, accompanied by a list thereof.

**CONTRACTOR:** *(Name and address)*

BY:

\_\_\_\_\_  
*(Signature of authorized representative)*

\_\_\_\_\_  
*(Printed name and title)*

Subscribed and sworn to before me on this date:

Notary Public:

My Commission Expires:



# AIA<sup>®</sup> Document G707<sup>™</sup> – 1994

## Consent Of Surety to Final Payment

PROJECT: *(Name and address)*

ARCHITECT'S PROJECT NUMBER:

OWNER:

CONTRACT FOR: General Construction

ARCHITECT:

TO OWNER: *(Name and address)*

CONTRACT DATED:

CONTRACTOR:

SURETY:

OTHER:

In accordance with the provisions of the Contract between the Owner and the Contractor as indicated above, the  
*(Insert name and address of Surety)*

on bond of  
*(Insert name and address of Contractor)*

, SURETY,

hereby approves of the final payment to the Contractor, and agrees that final payment to the Contractor shall not relieve the  
Surety of any of its obligations to  
*(Insert name and address of Owner)*

, CONTRACTOR,

as set forth in said Surety's bond.

, OWNER,

IN WITNESS WHEREOF, the Surety has hereunto set its hand on this date:  
*(Insert in writing the month followed by the numeric date and year.)*

\_\_\_\_\_  
*(Surety)*

\_\_\_\_\_  
*(Signature of authorized representative)*

Attest:  
*(Seal):*

\_\_\_\_\_  
*(Printed name and title)*



**CITY OF MOBILE, AL  
VENDOR INFORMATION FORM**

*Company Information:*

1. City Vendor Number:

2. Name of Company:

3. Company D.B.A. Name, if any:

4. Mailing Address:

5. Remittance Address:

6. Telephone:

7. Fax

8. Main Email:

*Primary Contact:*

9. Contact Name and Title:

10. Contact Phone:

11. Contact Fax:

12. Contact Email:

*Alternate Contact (if applicable):*

13. Alt. Contact Name and Title:

14. Alt. Contact Phone:

15. Alt. Contact Fax:

16. Alt. Contact Email:

*City of Mobile Business License Information:*

17. City of Mobile Business License No. (if required):

*Please attach additional sheets if necessary.*

## Request for Taxpayer Identification Number and Certification

**Give Form to the  
 requester. Do not  
 send to the IRS.**

|   |  |   |
|---|--|---|
| Print or type<br>See Specific Instructions on page 2. | Name (as shown on your income tax return)  |   |
|   | Business name/disregarded entity name, if different from above   |   |
|   | Check appropriate box for federal tax classification:<br><input type="checkbox"/> Individual/sole proprietor <input type="checkbox"/> C Corporation <input type="checkbox"/> S Corporation <input type="checkbox"/> Partnership <input type="checkbox"/> Trust/estate<br><br><input type="checkbox"/> Limited liability company. Enter the tax classification (C=C corporation, S=S corporation, P=partnership) ▶ _____<br><br><input type="checkbox"/> Other (see instructions) ▶ _____ |   |
|   | <input type="checkbox"/> Exempt payee  |   |
|   | Address (number, street, and apt. or suite no.)  | Requester's name and address (optional) |
| City, state, and ZIP code                             |  |   |
| List account number(s) here (optional)                |  |   |

### Part I Taxpayer Identification Number (TIN)

Enter your TIN in the appropriate box. The TIN provided must match the name given on the "Name" line to avoid backup withholding. For individuals, this is your social security number (SSN). However, for a resident alien, sole proprietor, or disregarded entity, see the Part I instructions on page 3. For other entities, it is your employer identification number (EIN). If you do not have a number, see *How to get a TIN* on page 3.

| Social security number |  |  |  |  |  |  |  |  |  |
|------------------------|--|--|--|--|--|--|--|--|--|
|                        |  |  |  |  |  |  |  |  |  |

**Note.** If the account is in more than one name, see the chart on page 4 for guidelines on whose number to enter.

| Employer identification number |  |  |  |  |  |  |  |  |  |
|--------------------------------|--|--|--|--|--|--|--|--|--|
|                                |  |  |  |  |  |  |  |  |  |

### Part II Certification

Under penalties of perjury, I certify that:

1. The number shown on this form is my correct taxpayer identification number (or I am waiting for a number to be issued to me), and
2. I am not subject to backup withholding because: (a) I am exempt from backup withholding, or (b) I have not been notified by the Internal Revenue Service (IRS) that I am subject to backup withholding as a result of a failure to report all interest or dividends, or (c) the IRS has notified me that I am no longer subject to backup withholding, and
3. I am a U.S. citizen or other U.S. person (defined below).

**Certification instructions.** You must cross out item 2 above if you have been notified by the IRS that you are currently subject to backup withholding because you have failed to report all interest and dividends on your tax return. For real estate transactions, item 2 does not apply. For mortgage interest paid, acquisition or abandonment of secured property, cancellation of debt, contributions to an individual retirement arrangement (IRA), and generally, payments other than interest and dividends, you are not required to sign the certification, but you must provide your correct TIN. See the instructions on page 4.

|                  |                            |        |
|------------------|----------------------------|--------|
| <b>Sign Here</b> | Signature of U.S. person ▶ | Date ▶ |
|------------------|----------------------------|--------|

### General Instructions

Section references are to the Internal Revenue Code unless otherwise noted.

#### Purpose of Form

A person who is required to file an information return with the IRS must obtain your correct taxpayer identification number (TIN) to report, for example, income paid to you, real estate transactions, mortgage interest you paid, acquisition or abandonment of secured property, cancellation of debt, or contributions you made to an IRA.

Use Form W-9 only if you are a U.S. person (including a resident alien), to provide your correct TIN to the person requesting it (the requester) and, when applicable, to:

1. Certify that the TIN you are giving is correct (or you are waiting for a number to be issued),
2. Certify that you are not subject to backup withholding, or
3. Claim exemption from backup withholding if you are a U.S. exempt payee. If applicable, you are also certifying that as a U.S. person, your allocable share of any partnership income from a U.S. trade or business is not subject to the withholding tax on foreign partners' share of effectively connected income.

**Note.** If a requester gives you a form other than Form W-9 to request your TIN, you must use the requester's form if it is substantially similar to this Form W-9.

**Definition of a U.S. person.** For federal tax purposes, you are considered a U.S. person if you are:

- An individual who is a U.S. citizen or U.S. resident alien,
- A partnership, corporation, company, or association created or organized in the United States or under the laws of the United States,
- An estate (other than a foreign estate), or
- A domestic trust (as defined in Regulations section 301.7701-7).

**Special rules for partnerships.** Partnerships that conduct a trade or business in the United States are generally required to pay a withholding tax on any foreign partners' share of income from such business. Further, in certain cases where a Form W-9 has not been received, a partnership is required to presume that a partner is a foreign person, and pay the withholding tax. Therefore, if you are a U.S. person that is a partner in a partnership conducting a trade or business in the United States, provide Form W-9 to the partnership to establish your U.S. status and avoid withholding on your share of partnership income.

## SECTION 00700

### GENERAL CONDITIONS OF THE CONTRACT FOR CONSTRUCTION, AIA DOCUMENT A201 - 2007

#### **PART 1 GENERAL**

This section includes the GENERAL CONDITIONS OF THE CONTRACT FOR CONSTRUCTION, AIA Document A-201, that is to be used for this Project. The document has been electronically modified to meet the City of Mobile's requirements and shall be used for the project.



# AIA<sup>®</sup>

# Document A201<sup>™</sup> – 2007

## General Conditions of the Contract for Construction

for the following PROJECT:  
*(Name and location or address)*

**THE OWNER:**

*(Name, legal status and address)*

City of Mobile

Architectural Engineering Department

P. O. Box 1827

Mobile, Alabama 36633-1827

**THE ARCHITECT:**

*(Name, legal status and address)*

This document has important legal consequences.

Consultation with an attorney is encouraged with respect to its completion or modification.

### TABLE OF ARTICLES

- |    |  |
|----|--|
| 1  | GENERAL PROVISIONS                               |
| 2  | OWNER  |
| 3  | CONTRACTOR                                       |
| 4  | ARCHITECT  |
| 5  | SUBCONTRACTORS                                   |
| 6  | CONSTRUCTION BY OWNER OR BY SEPARATE CONTRACTORS |
| 7  | CHANGES IN THE WORK                              |
| 8  | TIME   |
| 9  | PAYMENTS AND COMPLETION                          |
| 10 | PROTECTION OF PERSONS AND PROPERTY               |
| 11 | INSURANCE AND BONDS                              |
| 12 | UNCOVERING AND CORRECTION OF WORK                |
| 13 | MISCELLANEOUS PROVISIONS                         |
| 14 | TERMINATION OR SUSPENSION OF THE CONTRACT        |
| 15 | CLAIMS AND DISPUTES                              |

Init.

AIA Document A201<sup>™</sup> – 2007. Copyright © 1911, 1915, 1918, 1925, 1937, 1951, 1958, 1961, 1963, 1966, 1970, 1976, 1987, 1997 and 2007 by The American Institute of Architects. All rights reserved. WARNING: This AIA<sup>®</sup> Document is protected by U.S. Copyright Law and International Treaties. Unauthorized reproduction or distribution of this AIA<sup>®</sup> Document, or any portion of it, may result in severe civil and criminal penalties, and will be prosecuted to the maximum extent possible under the law. This document was produced by AIA software at 15:13:02 on 07/19/2017 under Order No.7986168957\_1 which expires on 08/01/2017, and is not for resale.

User Notes:

(1383216234)



## INDEX

(Topics and numbers in bold are section headings.)  
(Numbers and Topics in Bold are Section Headings)

### Acceptance of Nonconforming Work

9.6.6, 9.9.3, **12.3**

#### Acceptance of Work

9.6.6, 9.8.2, 9.9.3, 9.10.1, 9.10.3, 12.3

### Access to Work

**3.16**, 6.2.1, **12.1**

#### Accident Prevention

10

#### Acts and Omissions

3.2, 3.3.2, 3.12.8, 3.18, 4.2.3, 8.3.1, 9.5.1, 10.2.5,  
10.2.8, 13.4.2, ~~13.7~~, 13.7.1, 14.1, 15.2

#### Addenda

1.1.1, ~~3.11.3~~, 11.1

#### Additional Costs, Claims for

3.7.4, 3.7.5, 6.1.1, 7.3.7.5, 10.3, 15.1.4

### Additional Inspections and Testing

9.4.2, 9.8.3, 12.2.1, **13.5**

#### Additional Insured

11.1.4

#### Additional Time, Claims for

3.2.4, 3.7.4, 3.7.5, 3.10.2, 8.3.2, **15.1.5**

### Administration of the Contract

3.1.3, 4.2, 9.4, 9.5

#### Advertisement or Invitation to Bid

1.1.1

#### Aesthetic Effect

4.2.13

### Allowances

**3.8**, 7.3.8

#### All-risk Insurance

11.3.1, 11.3.1.1

### Applications for Payment

4.2.5, 7.3.9, 9.2, **9.3**, 9.4, 9.5.1, 9.6.3, ~~9.7~~, 9.7.1, 9.10,  
11.1.3

#### Approvals

2.1.1, 2.2.2, 2.4, 3.1.3, 3.10.2, 3.12.8, 3.12.9, 3.12.10,  
4.2.7, 9.3.2, 13.5.1

### Arbitration

8.3.1, 11.3.10, ~~13.1~~, 13.1.1, 15.3.2, **15.4**

## ARCHITECT

**4**

### Architect, Definition of

**4.1.1**

#### Architect, Extent of Authority

~~2.4~~, 2.4.1, 3.12.7, 4.1, 4.2, 5.2, ~~6.3~~, 6.3.1, 7.1.2, 7.3.7,  
7.4, ~~9.2~~, 9.2.1, 9.3.1, 9.4, 9.5, 9.6.3, 9.8, 9.10.1,  
9.10.3, 12.1, 12.2.1, 13.5.1, 13.5.2, 14.2.2, 14.2.4,  
15.1.3, 15.2.1

### Architect, Limitations of Authority and Responsibility

2.1.1, 3.12.4, 3.12.8, 3.12.10, 4.1.2, 4.2.1, 4.2.2,  
4.2.3, 4.2.6, 4.2.7, 4.2.10, 4.2.12, 4.2.13, 5.2.1, ~~7.4~~,  
7.4.1, 9.4.2, 9.5.3, 9.6.4, 15.1.3, 15.2

#### Architect's Additional Services and Expenses

~~2.4~~, 2.4.1, 11.3.1.1, 12.2.1, 13.5.2, 13.5.3, 14.2.4

#### Architect's Administration of the Contract

3.1.3, 4.2, 3.7.4, 15.2, 9.4.1, 9.5

#### Architect's Approvals

~~2.4~~, ~~3.1.3~~, ~~3.5~~, 2.4.1, 3.1.3, 3.5.1, 3.10.2, 4.2.7

#### Architect's Authority to Reject Work

~~3.5~~, 3.5.1, 4.2.6, 12.1.2, 12.2.1

#### Architect's Copyright

1.1.7, 1.5

#### Architect's Decisions

3.7.4, 4.2.6, 4.2.7, 4.2.11, 4.2.12, 4.2.13, 4.2.14, ~~6.3~~,  
6.3.1, 7.3.7, 7.3.9, 8.1.3, 8.3.1, ~~9.2~~, 9.2.1, 9.4.1, 9.5,  
9.8.4, 9.9.1, 13.5.2, 15.2, 15.3

#### Architect's Inspections

3.7.4, 4.2.2, 4.2.9, 9.4.2, 9.8.3, 9.9.2, 9.10.1, 13.5

#### Architect's Instructions

3.2.4, 3.3.1, 4.2.6, 4.2.7, 13.5.2

#### Architect's Interpretations

4.2.11, 4.2.12

#### Architect's Project Representative

4.2.10

#### Architect's Relationship with Contractor

1.1.2, 1.5, 3.1.3, 3.2.2, 3.2.3, 3.2.4, 3.3.1, 3.4.2, ~~3.5~~,  
3.5.1, 3.7.4, 3.7.5, 3.9.2, 3.9.3, 3.10, 3.11, 3.12, 3.16,  
3.18, 4.1.2, 4.1.3, 4.2, 5.2, 6.2.2, 7, 8.3.1, 9.2, 9.3,  
9.4, 9.5, 9.7, 9.8, 9.9, 10.2.6, 10.3, 11.3.7, 12, 13.4.2,  
13.5, 15.2

#### Architect's Relationship with Subcontractors

1.1.2, 4.2.3, 4.2.4, 4.2.6, 9.6.3, 9.6.4, 11.3.7

#### Architect's Representations

9.4.2, 9.5.1, 9.10.1

#### Architect's Site Visits

3.7.4, 4.2.2, 4.2.9, 9.4.2, 9.5.1, 9.9.2, 9.10.1, 13.5

#### Asbestos

10.3.1

#### Attorneys' Fees

3.18.1, 9.10.2, 10.3.3

#### Award of Separate Contracts

6.1.1, 6.1.2

### Award of Subcontracts and Other Contracts for Portions of the Work

**5.2**

### Basic Definitions

**1.1**

#### Bidding Requirements

1.1.1, 5.2.1, 11.4.1

#### Binding Dispute Resolution

~~9.7~~, 9.7.1, 11.3.9, 11.3.10, ~~13.1~~, 13.1.1, 15.2.5,  
15.2.6.1, 15.3.1, 15.3.2, 15.4.1

Int.

## **Boiler and Machinery Insurance**

### **11.3.2**

Bonds, Lien

7.3.7.4, 9.10.2, 9.10.3

### **Bonds, Performance, and Payment**

7.3.7.4, 9.6.7, 9.10.3, 11.3.9, 11.4

Building Permit

3.7.1

### **Capitalization**

#### **1.3**

Certificate of Substantial Completion

9.8.3, 9.8.4, 9.8.5

### **Certificates for Payment**

4.2.1, 4.2.5, 4.2.9, 9.3.3, 9.4, 9.5, 9.6.1, 9.6.6, 9.7,

9.7.1, 9.10.1, 9.10.3, 14.1.1.3, 14.2.4, 15.1.3

Certificates of Inspection, Testing or Approval

13.5.4

Certificates of Insurance

9.10.2, 11.1.3

### **Change Orders**

1.1.1, 2.4, 2.4.1, 3.4.2, 3.7.4, 3.8.2.3, 3.11, 3.11.1,

3.12.8, 4.2.8, 5.2.3, 7.1.2, 7.1.3, 7.2, 7.3.2, 7.3.6,

7.3.9, 7.3.10, 8.3.1, 9.3.1.1, 9.10.3, 10.3.2, 11.3.1.2,

11.3.4, 11.3.9, 12.1.2, 15.1.3

Change Orders, Definition of

7.2.1

### **CHANGES IN THE WORK**

2.2.1, 3.11, 4.2.8, 7, 7.2.1, 7.3.1, 7.4, 7.4.1, 8.3.1,

9.3.1.1, 11.3.9

Claims, Definition of

15.1.1

### **CLAIMS AND DISPUTES**

3.2.4, 6.1.1, 6.3, 6.3.1, 7.3.9, 9.3.3, 9.10.4, 10.3.3, 15,

15.4

Claims and Timely Assertion of Claims

15.4.1

Claims for Additional Cost

3.2.4, 3.7.4, 6.1.1, 7.3.9, 10.3.2, 15.1.4

Claims for Additional Time

3.2.4, 3.7.4, 6.1.1, 3.7.46.1.1, 8.3.2, 10.3.2, 15.1.5

Concealed or Unknown Conditions, Claims for

3.7.4

Claims for Damages

3.2.4, 3.18, 6.1.1, 8.3.3, 9.5.1, 9.6.7, 10.3.3, 11.1.1,

11.3.5, 11.3.7, 14.1.3, 14.2.4, 15.1.6

Claims Subject to Arbitration

15.3.1, 15.4.1

### **Cleaning Up**

3.15, 6.3

Commencement of the Work, Conditions Relating to

2.2.1, 3.2.2, 3.4.1, 3.7.1, 3.10.1, 3.12.6, 5.2.1, 5.2.3,

6.2.2, 8.1.2, 8.2.2, 8.3.1, 11.1, 11.3.1, 11.3.6, 11.4.1,

15.1.4

Commencement of the Work, Definition of

8.1.2

## **Communications Facilitating Contract**

### **Administration**

3.9.1, 4.2.4

Completion, Conditions Relating to

3.4.1, 3.11, 3.15, 4.2.2, 4.2.9, 8.2, 9.4.2, 9.8, 9.9.1,

9.10, 12.2, 13.7, 14.1.2

### **COMPLETION, PAYMENTS AND**

**9**

Completion, Substantial

4.2.9, 8.1.1, 8.1.3, 8.2.3, 9.4.2, 9.8, 9.9.1, 9.10.3,

12.2, 13.7

Compliance with Laws

1.6, 1.6.1, 3.2.3, 3.6, 3.7, 3.12.10, 3.13, 4.1.1, 9.6.4,

10.2.2, 11.1, 11.3, 13.1, 13.4, 13.5.1, 13.5.2, 13.6,

14.1.1, 14.2.1.3, 15.2.8, 15.4.2, 15.4.3

Concealed or Unknown Conditions

3.7.4, 4.2.8, 8.3.1, 10.3

Conditions of the Contract

1.1.1, 6.1.1, 6.1.4

Consent, Written

3.4.2, 3.7.4, 3.12.8, 3.14.2, 4.1.2, 9.3.2, 9.8.5, 9.9.1,

9.10.2, 9.10.3, 11.3.1, 13.2, 13.4.2, 15.4.4.2

Consolidation or Joinder

15.4.4

### **CONSTRUCTION BY OWNER OR BY**

#### **SEPARATE CONTRACTORS**

1.1.4, 6

Construction Change Directive, Definition of

7.3.1

Construction Change Directives

1.1.1, 3.4.2, 3.12.8, 4.2.8, 7.1.1, 7.1.2, 7.1.3, 7.3,

9.3.1.1

Construction Schedules, Contractor's

3.10, 3.12.1, 3.12.2, 6.1.3, 15.1.5.2

Contingent Assignment of Subcontracts

5.4, 14.2.2.2

Continuing Contract Performance

15.1.3

Contract, Definition of

1.1.2

### **CONTRACT, TERMINATION OR**

#### **SUSPENSION OF THE**

5.4.1.1, 11.3.9, 14

Contract Administration

3.1.3, 4, 9.4, 9.5

Contract Award and Execution, Conditions Relating

to

3.7.1, 3.10, 5.2, 6.1, 11.1.3, 11.3.6, 11.4.1

Contract Documents, The

1.1.1

Contract Documents, Copies Furnished and Use of

1.5.2, 2.2.5, 5.3

Contract Documents, Definition of

1.1.1

**Contract Sum**

3.7.4, 3.8, 5.2.3, 7.2, 7.3, 7.4, 9.1, 9.4.2, 9.5.1.4, 9.6.7, 9.7, 10.3.2, 11.3.1, 14.2.4, 14.3.2, 15.1.4, 15.2.5

**Contract Sum, Definition of****9.1****Contract Time**

3.7.4, 3.7.5, 3.10.2, 5.2.3, 7.2.1.3, 7.3.1, 7.3.5, 7.4, 8.1.1, 8.2.1, 8.3.1, 9.5.1, ~~9.7~~, ~~9.7.1~~, 10.3.2, 12.1.1, 14.3.2, 15.1.5.1, 15.2.5

**Contract Time, Definition of****8.1.1****CONTRACTOR****3****Contractor, Definition of****3.1, 6.1.2****Contractor's Construction Schedules**

3.10, 3.12.1, 3.12.2, 6.1.3, 15.1.5.2

**Contractor's Employees**

3.3.2, 3.4.3, 3.8.1, 3.9, 3.18.2, 4.2.3, 4.2.6, 10.2, 10.3, 11.1.1, 11.3.7, 14.1, ~~14.2.1~~, 14.2.1.1

**Contractor's Liability Insurance****11.1****Contractor's Relationship with Separate Contractors and Owner's Forces**

3.12.5, 3.14.2, 4.2.4, 6, 11.3.7, 12.1.2, 12.2.4

**Contractor's Relationship with Subcontractors**

1.2.2, 3.3.2, 3.18.1, 3.18.2, 5, 9.6.2, 9.6.7, 9.10.2, 11.3.1.2, 11.3.7, 11.3.8

**Contractor's Relationship with the Architect**

1.1.2, 1.5, 3.1.3, 3.2.2, 3.2.3, 3.2.4, 3.3.1, 3.4.2, ~~3.5~~, ~~3.5.1~~, 3.7.4, 3.10, 3.11, 3.12, 3.16, 3.18, 4.1.3, 4.2, 5.2, 6.2.2, 7, 8.3.1, 9.2, 9.3, 9.4, 9.5, 9.7, 9.8, 9.9, 10.2.6, 10.3, 11.3.7, 12, 13.5, 15.1.2, 15.2.1

**Contractor's Representations**

3.2.1, 3.2.2, ~~3.5~~, ~~3.5.1~~, 3.12.6, 6.2.2, 8.2.1, 9.3.3, 9.8.2

**Contractor's Responsibility for Those Performing the Work**

3.3.2, 3.18, ~~5.3~~, ~~5.3.1~~, 6.1.3, 6.2, 9.5.1, 10.2.8

**Contractor's Review of Contract Documents****3.2****Contractor's Right to Stop the Work****9.7****Contractor's Right to Terminate the Contract**

14.1, 15.1.6

**Contractor's Submittals**

3.10, 3.11, 3.12.4, 4.2.7, 5.2.1, 5.2.3, 9.2, 9.3, 9.8.2, 9.8.3, 9.9.1, 9.10.2, 9.10.3, 11.1.3, 11.4.2

**Contractor's Superintendent**

3.9, 10.2.6

**Contractor's Supervision and Construction****Procedures**

1.2.2, 3.3, 3.4, 3.12.10, 4.2.2, 4.2.7, 6.1.3, 6.2.4, 7.1.3, 7.3.5, 7.3.7, 8.2, 10, 12, 14, 15.1.3

**Contractual Liability Insurance**

11.1.1.8, 11.2

**Coordination and Correlation**

1.2, 3.2.1, 3.3.1, 3.10, 3.12.6, 6.1.3, 6.2.1

**Copies Furnished of Drawings and Specifications**

1.5, 2.2.5, 3.11

**Copyrights**

1.5, 3.17

**Correction of Work**

2.3, 2.4, 3.7.3, 9.4.2, 9.8.2, 9.8.3, 9.9.1, 12.1.2, 12.2

**Correlation and Intent of the Contract Documents****1.2****Cost, Definition of****7.3.7****Costs**

~~2.4~~, ~~2.4.1~~, 3.2.4, 3.7.3, 3.8.2, 3.15.2, 5.4.2, 6.1.1, 6.2.3, 7.3.3.3, 7.3.7, 7.3.8, 7.3.9, 9.10.2, 10.3.2, 10.3.6, 11.3, 12.1.2, 12.2.1, 12.2.4, 13.5, 14

**Cutting and Patching****3.14, 6.2.5****Damage to Construction of Owner or Separate Contractors**

3.14.2, 6.2.4, 10.2.1.2, 10.2.5, 10.4, 11.1.1, 11.3, 12.2.4

**Damage to the Work**

3.14.2, 9.9.1, 10.2.1.2, 10.2.5, ~~10.4~~, 10.4.1, 11.3.1, 12.2.4

**Damages, Claims for**

3.2.4, 3.18, 6.1.1, 8.3.3, 9.5.1, 9.6.7, 10.3.3, 11.1.1, 11.3.5, 11.3.7, 14.1.3, 14.2.4, 15.1.6

**Damages for Delay**

6.1.1, 8.3.3, 9.5.1.6, 9.7, 10.3.2

**Date of Commencement of the Work, Definition of****8.1.2****Date of Substantial Completion, Definition of****8.1.3****Day, Definition of****8.1.4****Decisions of the Architect**

3.7.4, 4.2.6, 4.2.7, 4.2.11, 4.2.12, 4.2.13, 15.2, 6.3, 7.3.7, 7.3.9, 8.1.3, 8.3.1, ~~9.2~~, ~~9.2.1~~, 9.4, 9.5.1, 9.8.4, 9.9.1, 13.5.2, 14.2.2, 14.2.4, 15.1, 15.2

**Decisions to Withhold Certification**

9.4.1, 9.5, 9.7, 14.1.1.3

**Defective or Nonconforming Work, Acceptance, Rejection and Correction of**

~~2.3~~, ~~2.4~~, ~~3.5~~, ~~2.3.1~~, ~~2.4.1~~, ~~3.5.1~~, 4.2.6, 6.2.5, 9.5.1, 9.5.2, 9.6.6, 9.8.2, 9.9.3, 9.10.4, 12.2.1

**Defective Work, Definition of****3.5.1****Definitions**

1.1, 2.1.1, 3.1.1, ~~3.5~~, ~~3.5.1~~, 3.12.1, 3.12.2, 3.12.3, 4.1.1, 15.1.1, 5.1, 6.1.2, 7.2.1, 7.3.1, 8.1, 9.1, 9.8.1

**Delays and Extensions of Time**

~~3.2~~, ~~3.2.1~~, 3.7.4, 5.2.3, 7.2.1, 7.3.1, ~~7.4~~, ~~7.4.1~~, 8.3, 9.5.1, ~~9.7~~, ~~10.3.2~~, ~~10.4~~, ~~9.7.1~~, 10.3.2, 10.4.1, 14.3.2, 15.1.5, 15.2.5

**Disputes**

~~6.3~~, ~~6.3.1~~, 7.3.9, 15.1, 15.2

## Documents and Samples at the Site

### 3.11

#### Drawings, Definition of

##### 1.1.5

Drawings and Specifications, Use and Ownership of  
3.11

#### Effective Date of Insurance

8.2.2, 11.1.2

#### Emergencies

10.4, 14.1.1.2, 15.1.4

#### Employees, Contractor's

3.3.2, 3.4.3, 3.8.1, 3.9, 3.18.2, 4.2.3, 4.2.6, 10.2,  
10.3.3, 11.1.1, 11.3.7, 14.1, 14.2.1.1

#### Equipment, Labor, Materials or

1.1.3, 1.1.6, 3.4, ~~3.5~~, ~~3.5.1~~, 3.8.2, 3.8.3, 3.12, ~~3.13~~,  
3.13.1, 3.15.1, 4.2.6, 4.2.7, 5.2.1, 6.2.1, 7.3.7, 9.3.2,  
9.3.3, 9.5.1.3, 9.10.2, 10.2.1, 10.2.4, 14.2.1.1,  
14.2.1.2

#### Execution and Progress of the Work

1.1.3, 1.2.1, 1.2.2, 2.2.3, 2.2.5, 3.1, 3.3.1, 3.4.1, ~~3.5~~,  
~~3.5.1~~, 3.7.1, 3.10.1, 3.12, 3.14, 4.2, 6.2.2, 7.1.3, 7.3.5,  
8.2, 9.5.1, 9.9.1, 10.2, 10.3, 12.2, 14.2, 14.3.1, 15.1.3

#### Extensions of Time

3.2.4, 3.7.4, 5.2.3, 7.2.1, 7.3, 7.4, 9.5.1, 9.7, ~~10.3.2~~,  
~~10.4~~, ~~7.4.1~~, ~~9.5.1~~, ~~9.7.1~~, ~~10.3.2~~, ~~10.4.1~~, 14.3, 15.1.5,  
15.2.5

#### Failure of Payment

9.5.1.3, 9.7, 9.10.2, 13.6, 14.1.1.3, 14.2.1.2

#### Faulty Work

(See Defective or Nonconforming Work)

#### Final Completion and Final Payment

4.2.1, 4.2.9, 9.8.2, ~~9.10~~, 11.1.2, 11.1.3, 11.3.1, 11.3.5,  
~~12.3~~, ~~12.3.1~~, 14.2.4, 14.4.3

#### Financial Arrangements, Owner's

2.2.1, 13.2.2, 14.1.1.4

#### Fire and Extended Coverage Insurance

11.3.1.1

## GENERAL PROVISIONS

1

#### Governing Law

13.1

#### Guarantees (See Warranty)

#### Hazardous Materials

10.2.4, 10.3

#### Identification of Subcontractors and Suppliers

5.2.1

#### Indemnification

~~3.17~~, ~~3.17.1~~, 3.18, 9.10.2, 10.3.3, 10.3.5, 10.3.6,  
11.3.1.2, 11.3.7

#### Information and Services Required of the Owner

2.1.2, 2.2, 3.2.2, 3.12.4, 3.12.10, 6.1.3, 6.1.4, 6.2.5,  
9.6.1, 9.6.4, 9.9.2, 9.10.3, 10.3.3, 11.2, 11.4, 13.5.1,  
13.5.2, 14.1.1.4, 14.1.4, 15.1.3

#### Initial Decision

15.2

#### Initial Decision Maker, Definition of

1.1.8

#### Initial Decision Maker, Decisions

14.2.2, 14.2.4, 15.2.1, 15.2.2, 15.2.3, 15.2.4, 15.2.5

#### Initial Decision Maker, Extent of Authority

14.2.2, 14.2.4, 15.1.3, 15.2.1, 15.2.2, 15.2.3, 15.2.4,  
15.2.5

#### Injury or Damage to Person or Property

10.2.8, ~~10.4~~10.4.1

#### Inspections

3.1.3, 3.3.3, 3.7.1, 4.2.2, 4.2.6, 4.2.9, 9.4.2, 9.8.3,  
9.9.2, 9.10.1, 12.2.1, 13.5

#### Instructions to Bidders

1.1.1

#### Instructions to the Contractor

3.2.4, 3.3.1, 3.8.1, 5.2.1, 7, 8.2.2, 12, 13.5.2

#### Instruments of Service, Definition of

1.1.7

#### Insurance

3.18.1, 6.1.1, 7.3.7, 9.3.2, 9.8.4, 9.9.1, 9.10.2, 11

#### Insurance, Boiler and Machinery

11.3.2

#### Insurance, Contractor's Liability

11.1

#### Insurance, Effective Date of

8.2.2, 11.1.2

#### Insurance, Loss of Use

11.3.3

#### Insurance, Owner's Liability

11.2

#### Insurance, Property

10.2.5, 11.3

#### Insurance, Stored Materials

~~9.3.2~~9.3.2, 11.4.1.4

## INSURANCE AND BONDS

11

#### Insurance Companies, Consent to Partial Occupancy

~~9.9.1~~9.9.1, 11.4.1.5

#### Insurance Companies, Settlement with

11.4.10

#### Intent of the Contract Documents

1.2.1, 4.2.7, 4.2.12, 4.2.13, 7.4

#### Interest

13.6

#### Interpretation

1.2.3, 1.4, 4.1.1, 5.1, 6.1.2, 15.1.1

#### Interpretations, Written

4.2.11, 4.2.12, 15.1.4

#### Judgment on Final Award

15.4.2

#### Labor and Materials, Equipment

1.1.3, 1.1.6, 3.4, ~~3.5~~, ~~3.5.1~~, 3.8.2, 3.8.3, 3.12, 3.13,  
3.15.1, 4.2.6, 4.2.7, 5.2.1, 6.2.1, 7.3.7, 9.3.2, 9.3.3,  
9.5.1.3, 9.10.2, 10.2.1, 10.2.4, 14.2.1.1, 14.2.1.2

#### Labor Disputes

8.3.1

## Laws and Regulations

1.5, 3.2.3, 3.6, 3.7, 3.12.10, ~~3.13~~, ~~3.13.1~~, 4.1.1, 9.6.4, 9.9.1, 10.2.2, 11.1.1, 11.3, ~~13.1~~, ~~13.1.1~~, 13.4, 13.5.1, 13.5.2, ~~13.6~~, ~~13.6.1~~, 14, 15.2.8, 15.4

## Liens

2.1.2, 9.3.3, 9.10.2, 9.10.4, 15.2.8

## Limitations, Statutes of

12.2.5, 13.7, 15.4.1.1

## Limitations of Liability

~~2.3~~, ~~3.2.2~~, ~~3.5~~, ~~3.12.10~~, ~~3.17~~, ~~2.3.1~~, ~~3.2.2~~, ~~3.5.1~~, ~~3.12.10~~, ~~3.17.1~~, 3.18.1, 4.2.6, 4.2.7, 4.2.12, 6.2.2, 9.4.2, 9.6.4, 9.6.7, 10.2.5, 10.3.3, 11.1.2, 11.2, 11.3.7, 12.2.5, 13.4.2

## Limitations of Time

2.1.2, 2.2, 2.4, 3.2.2, 3.10, 3.11, 3.12.5, 3.15.1, 4.2.7, 5.2, ~~5.3~~, ~~5.3.1~~, 5.4.1, 6.2.4, 7.3, 7.4, 8.2, ~~9.2~~, ~~9.2.1~~, 9.3.1, 9.3.3, 9.4.1, 9.5, 9.6, ~~9.7~~, ~~9.7.1~~, 9.8, 9.9, 9.10, 11.1.3, 11.3.1.5, 11.3.6, 11.3.10, 12.2, 13.5, 13.7, 14, 15

## Loss of Use Insurance

11.3.3

## Material Suppliers

1.5, 3.12.1, 4.2.4, 4.2.6, 5.2.1, 9.3, 9.4.2, 9.6, 9.10.5

## Materials, Hazardous

10.2.4, 10.3

## Materials, Labor, Equipment and

1.1.3, 1.1.6, 1.5.1, 3.4.1, ~~3.5~~, ~~3.5.1~~, 3.8.2, 3.8.3, 3.12, ~~3.13~~, ~~3.13.1~~, 3.15.1, 4.2.6, 4.2.7, 5.2.1, 6.2.1, 7.3.7, 9.3.2, 9.3.3, 9.5.1.3, 9.10.2, 10.2.1.2, 10.2.4, 14.2.1.1, 14.2.1.2

## Means, Methods, Techniques, Sequences and

## Procedures of Construction

3.3.1, 3.12.10, 4.2.2, 4.2.7, 9.4.2

## Mechanic's Lien

2.1.2, 15.2.8

## Mediation

8.3.1, 10.3.5, 10.3.6, 15.2.1, 15.2.5, 15.2.6, 15.3, 15.4.1

## Minor Changes in the Work

1.1.1, 3.12.8, 4.2.8, 7.1, 7.4

## MISCELLANEOUS PROVISIONS

13

## Modifications, Definition of

1.1.1

## Modifications to the Contract

1.1.1, 1.1.2, 3.11, 4.1.2, 4.2.1, 5.2.3, 7, 8.3.1, ~~9.7~~, ~~9.7.1~~, 10.3.2, 11.3.1

## Mutual Responsibility

6.2

## Nonconforming Work, Acceptance of

9.6.6, 9.9.3, 12.3

## Nonconforming Work, Rejection and Correction of

~~2.3~~, ~~2.4~~, ~~3.5~~, ~~2.3.1~~, ~~2.4.1~~, ~~3.5.1~~, 4.2.6, 6.2.4, 9.5.1, 9.8.2, 9.9.3, 9.10.4, 12.2.1

## Notice

2.2.1, ~~2.3~~, ~~2.4~~, ~~2.3.1~~, ~~2.4.1~~, 3.2.4, 3.3.1, 3.7.2, 3.12.9, 5.2.1, ~~9.7~~, ~~9.7.1~~, 9.10, 10.2.2, 11.1.3, ~~11.4.6~~, 12.2.2.1, 13.3, 13.5.1, 13.5.2, 14.1, 14.2, 15.2.8, 15.4.1

## Notice, Written

~~2.3~~, ~~2.4~~, ~~2.3.1~~, ~~2.4.1~~, 3.3.1, 3.9.2, 3.12.9, 3.12.10, 5.2.1, ~~9.7~~, ~~9.7.1~~, 9.10, 10.2.2, 10.3, 11.1.3, 11.3.6, 12.2.2.1, 13.3, 14, 15.2.8, 15.4.1

## Notice of Claims

3.7.4, 4.5, 10.2.8, 15.1.2, 15.4

## Notice of Testing and Inspections

13.5.1, 13.5.2

## Observations, Contractor's

3.2, 3.7.4

## Occupancy

2.2.2, 9.6.6, 9.8, 11.3.1.5

## Orders, Written

1.1.1, 2.3, 3.9.2, 7, 8.2.2, 11.3.9, 12.1, 12.2.2.1, 13.5.2, 14.3.1

## OWNER

2

## Owner, Definition of

2.1.1

## Owner, Information and Services Required of the

2.1.2, 2.2, 3.2.2, 3.12.10, 6.1.3, 6.1.4, 6.2.5, 9.3.2, 9.6.1, 9.6.4, 9.9.2, 9.10.3, 10.3.3, 11.2, 11.3, 13.5.1, 13.5.2, 14.1.1.4, 14.1.4, 15.1.3

## Owner's Authority

1.5, 2.1.1, ~~2.3~~, ~~2.4~~, ~~2.3.1~~, ~~2.4.1~~, 3.4.2, 3.8.1, 3.12.10, 3.14.2, 4.1.2, 4.1.3, 4.2.4, 4.2.9, 5.2.1, 5.2.4, 5.4.1, 6.1, ~~6.3~~, ~~6.3.1~~, 7.2.1, 7.3.1, 8.2.2, 8.3.1, 9.3.1, 9.3.2, 9.5.1, 9.6.4, 9.9.1, 9.10.2, 10.3.2, 11.1.3, 11.3.3, 11.3.10, 12.2.2, ~~12.3~~, ~~12.3.1~~, 13.2.2, 14.3, 14.4, 15.2.7

## Owner's Financial Capability

2.2.1, 13.2.2, 14.1.1.4

## Owner's Liability Insurance

11.2

## Owner's Loss of Use Insurance

11.3.3

## Owner's Relationship with Subcontractors

1.1.2, 5.2, 5.3, 5.4, 9.6.4, 9.10.2, 14.2.2

## Owner's Right to Carry Out the Work

2.4, 14.2.2

## Owner's Right to Clean Up

6.3

## Owner's Right to Perform Construction and to Award Separate Contracts

6.1

## Owner's Right to Stop the Work

2.3

## Owner's Right to Suspend the Work

14.3

## Owner's Right to Terminate the Contract

14.2

init.

AIA Document A201™ - 2007. Copyright © 1911, 1915, 1918, 1925, 1937, 1951, 1958, 1961, 1963, 1966, 1970, 1976, 1987, 1997 and 2007 by The American Institute of Architects. All rights reserved. WARNING: This AIA® Document is protected by U.S. Copyright Law and International Treaties. Unauthorized reproduction or distribution of this AIA® Document, or any portion of it, may result in severe civil and criminal penalties, and will be prosecuted to the maximum extent possible under the law. This document was produced by AIA software at 15:13:02 on 07/19/2017 under Order No.7986168957\_1 which expires on 08/01/2017, and is not for resale.

User Notes:

(1383216234)

**Ownership and Use of Drawings, Specifications and Other Instruments of Service**

1.1.1, 1.1.6, 1.1.7, 1.5, 2.2.5, 3.2.2, ~~3.11, 3.17, 4.2.12, 5.3.11.1, 3.17.1, 4.2.12, 5.3.1~~

**Partial Occupancy or Use**

9.6.6, 9.9, 11.3.1.5

**Patching, Cutting and**

3.14, 6.2.5

**Patents**

3.17

**Payment, Applications for**

4.2.5, 7.3.9, ~~9.2, 9.2.1, 9.3, 9.4, 9.5, 9.6.3, 9.7, 9.7.1, 9.8.5, 9.10.1, 14.2.3, 14.2.4, 14.4.3~~

**Payment, Certificates for**

4.2.5, 4.2.9, 9.3.3, 9.4, 9.5, 9.6.1, 9.6.6, ~~9.7, 9.7.1, 9.10.1, 9.10.3, 13.7, 14.1.1.3, 14.2.4~~

**Payment, Failure of**

9.5.1.3, 9.7, 9.10.2, 13.6, 14.1.1.3, 14.2.1.2

**Payment, Final**

4.2.1, 4.2.9, 9.8.2, 9.10, 11.1.2, 11.1.3, 11.4.1, ~~12.3, 11.4.5, 12.3.1, 13.7, 14.2.4, 14.4.3~~

**Payment Bond, Performance Bond and**

7.3.7.4, 9.6.7, 9.10.3, ~~11.4.9, 11.4~~

**Payments, Progress**

9.3, 9.6, 9.8.5, 9.10.3, 13.6, 14.2.3, 15.1.3

**PAYMENTS AND COMPLETION**

9

**Payments to Subcontractors**

5.4.2, 9.5.1.3, 9.6.2, 9.6.3, 9.6.4, 9.6.7, ~~11.4.8, 14.2.1.2~~

**PCB**

10.3.1

**Performance Bond and Payment Bond**

7.3.7.4, 9.6.7, 9.10.3, ~~11.4.9, 11.4~~

**Permits, Fees, Notices and Compliance with Laws**

2.2.2, 3.7, 3.13, 7.3.7.4, 10.2.2

**PERSONS AND PROPERTY PROTECTION OF**

10

**Polychlorinated Biphenyl**

10.3.1

**Product Data, Definition of**

3.12.2

**Product Data and Samples, Shop Drawings**

3.11, 3.12, 4.2.7

**Progress and Completion**

4.2.2, 8.2, 9.8, 9.9.1, 14.1.4, 15.1.3

**Progress Payments**

9.3, 9.6, 9.8.5, 9.10.3, 13.6, 14.2.3, 15.1.3

**Project, Definition of the**

1.1.4

**Project Representatives**

4.2.10

**Property Insurance**

10.2.5, 11.3

**PROTECTION OF PERSONS AND PROPERTY**

10

**Regulations and Laws**

1.5, 3.2.3, 3.6, 3.7, 3.12.10, 3.13, 4.1.1, 9.6.4, 9.9.1, 10.2.2, 11.1, 11.4, 13.1, 13.4, 13.5.1, 13.5.2, 13.6, 14, 15.2.8, 15.4

**Rejection of Work**

~~3.5, 3.5.1, 4.2.6, 12.2.1~~

**Releases and Waivers of Liens**

9.10.2

**Representations**

3.2.1, ~~3.5, 3.5.1, 3.12.6, 6.2.2, 8.2.1, 9.3.3, 9.4.2, 9.5.1, 9.8.2, 9.10.1~~

**Representatives**

2.1.1, 3.1.1, 3.9, 4.1.1, 4.2.1, 4.2.2, 4.2.10, 5.1.1, 5.1.2, 13.2.1

**Responsibility for Those Performing the Work**

3.3.2, 3.18, 4.2.3, ~~5.3, 5.3.1, 6.1.3, 6.2, 6.3, 9.5.1, 10~~

**Retainage**

9.3.1, 9.6.2, 9.8.5, 9.9.1, 9.10.2, 9.10.3

**Review of Contract Documents and Field**

**Conditions by Contractor**

3.2, 3.12.7, 6.1.3

**Review of Contractor's Submittals by Owner and Architect**

3.10.1, 3.10.2, 3.11, 3.12, 4.2, 5.2, 6.1.3, 9.2, 9.8.2

**Review of Shop Drawings, Product Data and**

**Samples by Contractor**

3.12

**Rights and Remedies**

1.1.2, 2.3, 2.4, ~~3.5, 3.5.1, 3.7.4, 3.15.2, 4.2.6, 4.5, 5.3, 5.4, 6.1, 6.3, 7.3.1, 8.3, 9.5.1, 9.7, 10.2.5, 10.3, 12.2.2, 12.2.4, 13.4, 14, 15.4~~

**Royalties, Patents and Copyrights**

3.17

**Rules and Notices for Arbitration**

15.4.1

**Safety of Persons and Property**

10.2, 10.4

**Safety Precautions and Programs**

3.3.1, 4.2.2, 4.2.7, ~~5.3, 5.3.1, 10.1, 10.2, 10.4~~

**Samples, Definition of**

3.12.3

**Samples, Shop Drawings, Product Data and**

3.11, 3.12, 4.2.7

**Samples at the Site, Documents and**

3.11

**Schedule of Values**

9.2, 9.3.1

**Schedules, Construction**

3.10, 3.12.1, 3.12.2, 6.1.3, 15.1.5.2

**Separate Contracts and Contractors**

1.1.4, 3.12.5, 3.14.2, 4.2.4, 4.2.7, 6, 8.3.1, ~~11.4.7, 12.1.2~~

**Shop Drawings, Definition of**

3.12.1

**Shop Drawings, Product Data and Samples**

3.11, 3.12, 4.2.7

Init.

AIA Document A201™ – 2007. Copyright © 1911, 1915, 1918, 1925, 1937, 1951, 1958, 1961, 1963, 1966, 1970, 1976, 1987, 1997 and 2007 by The American Institute of Architects. All rights reserved. WARNING: This AIA® Document is protected by U.S. Copyright Law and International Treaties. Unauthorized reproduction or distribution of this AIA® Document, or any portion of it, may result in severe civil and criminal penalties, and will be prosecuted to the maximum extent possible under the law. This document was produced by AIA software at 15:13:02 on 07/19/2017 under Order No.7986168957\_1 which expires on 08/01/2017, and is not for resale.

User Notes:

(1383216234)

**Site, Use of**

3.13, 6.1.1, 6.2.1

**Site Inspections**

3.2.2, 3.3.3, 3.7.1, 3.7.4, 4.2, 9.4.2, 9.10.1, 13.5

**Site Visits, Architect's**

3.7.4, 4.2.2, 4.2.9, 9.4.2, 9.5.1, 9.9.2, 9.10.1, 13.5

**Special Inspections and Testing**

4.2.6, 12.2.1, 13.5

**Specifications, Definition of the**

1.1.6

**Specifications, The**

1.1.1, 1.1.6, 1.2.2, 1.5, 3.11, 3.12.10, 3.17, 4.2.14

**Statute of Limitations**

13.7, 15.4.1.1

**Stopping the Work**

2.3, 9.7, 10.3, 14.1

**Stored Materials**

6.2.1, 9.3.2, 10.2.1.2, ~~10.2.4~~ 10.2.4, 11.4.1.4

**Subcontractor, Definition of**

5.1.1

**SUBCONTRACTORS**

5

**Subcontractors, Work by**

1.2.2, 3.3.2, 3.12.1, 4.2.3, 5.2.3, 5.3, 5.4, 9.3.1.2, 9.6.7

**Subcontractual Relations**

5.3, 5.4, 9.3.1.2, 9.6, 9.10, 10.2.1, 11.4.7, 11.4.8, 14.1, 14.2.1

**Submittals**

3.10, 3.11, 3.12, 4.2.7, 5.2.1, 5.2.3, 7.3.7, 9.2, 9.3, 9.8, 9.9.1, 9.10.2, 9.10.3, 11.1.3

**Submittal Schedule**

3.10.2, 3.12.5, 4.2.7

**Subrogation, Waivers of**

6.1.1, 11.4.5, 11.3.7

**Substantial Completion**

4.2.9, 8.1.1, 8.1.3, 8.2.3, 9.4.2, 9.8, 9.9.1, 9.10.3, 12.2, 13.7

**Substantial Completion, Definition of**

9.8.1

**Substitution of Subcontractors**

5.2.3, 5.2.4

**Substitution of Architect**

4.1.3

**Substitutions of Materials**

3.4.2, ~~3.5, 3.5.1~~, 7.3.8

**Sub-subcontractor, Definition of**

5.1.2

**Subsurface Conditions**

3.7.4

**Successors and Assigns**

13.2

**Superintendent**

3.9, 10.2.6

**Supervision and Construction Procedures**

1.2.2, 3.3, 3.4, 3.12.10, 4.2.2, 4.2.7, 6.1.3, 6.2.4, 7.1.3, 7.3.7, 8.2, 8.3.1, 9.4.2, 10, 12, 14, 15.1.3

**Surety**

5.4.1.2, 9.8.5, 9.10.2, 9.10.3, 14.2.2, 15.2.7

**Surety, Consent of**

9.10.2, 9.10.3

**Surveys**

2.2.3

**Suspension by the Owner for Convenience**

14.3

**Suspension of the Work**

5.4.2, 14.3

**Suspension or Termination of the Contract**

5.4.1.1, 11.4.9, 14

**Taxes**

3.6, 3.8.2.1, 7.3.7.4

**Termination by the Contractor**

14.1, 15.1.6

**Termination by the Owner for Cause**

5.4.1.1, 14.2, 15.1.6

**Termination by the Owner for Convenience**

14.4

**Termination of the Architect**

4.1.3

**Termination of the Contractor**

14.2.2

**TERMINATION OR SUSPENSION OF THE CONTRACT**

14

**Tests and Inspections**

3.1.3, 3.3.3, 4.2.2, 4.2.6, 4.2.9, 9.4.2, 9.8.3, 9.9.2, 9.10.1, 10.3.2, ~~11.4.1~~, 11.4.1.1, 12.2.1, 13.5

**TIME**

8

**Time, Delays and Extensions of**

3.2.4, 3.7.4, 5.2.3, 7.2.1, 7.3.1, ~~7.4, 7.4.1~~, 8.3, 9.5.1, ~~9.7, 10.3.2, 10.4, 9.7.1, 10.3.2, 10.4.1~~, 14.3.2, 15.1.5, 15.2.5

**Time Limits**

2.1.2, 2.2, 2.4, 3.2.2, 3.10, 3.11, 3.12.5, 3.15.1, 4.2, 4.4, 4.5, 5.2, 5.3, 5.4, 6.2.4, 7.3, 7.4, 8.2, 9.2, 9.3.1, 9.3.3, 9.4.1, 9.5, 9.6, 9.7, 9.8, 9.9, 9.10, 11.1.3, 11.4.1.5, 11.4.6, 11.4.10, 12.2, 13.5, 13.7, 14, 15.1.2, 15.4

**Time Limits on Claims**

3.7.4, 10.2.8, 13.7, 15.1.2

**Title to Work**

9.3.2, 9.3.3

**Transmission of Data in Digital Form**

1.6

**UNCOVERING AND CORRECTION OF WORK**

12

**Uncovering of Work**

12.1

**Unforeseen Conditions, Concealed or Unknown**

3.7.4, 8.3.1, 10.3

**Unit Prices**

7.3.3.2, 7.3.4

**Use of Documents**

1.1.1, 1.5, 2.2.5, 3.12.6, 5.3

**Use of Site**

3.13, 6.1.1, 6.2.1

**Values, Schedule of**

9.2, 9.3.1

**Waiver of Claims by the Architect**

13.4.2

**Waiver of Claims by the Contractor**

9.10.5, 11.4.7, 13.4.2, 15.1.6

**Waiver of Claims by the Owner**

9.9.3, 9.10.3, 9.10.4, 11.4.3, 11.4.5, 11.4.7, 12.2.2.1, 13.4.2, 14.2.4, 15.1.6

**Waiver of Consequential Damages**

14.2.4, 15.1.6

**Waiver of Liens**

9.10.2, 9.10.4

**Waivers of Subrogation**

6.1.1, 11.4.5, 11.3.7

**Warranty**

3.5, 4.2.9, 9.3.3, 9.8.4, 9.9.1, 9.10.4, 12.2.2, ~~13.7~~  
13.7.1

**Weather Delays**

15.1.5.2

**Work, Definition of**

1.1.3

**Written Consent**

1.5.2, 3.4.2, 3.7.4, 3.12.8, 3.14.2, 4.1.2, 9.3.2, 9.8.5, 9.9.1, 9.10.2, 9.10.3, 11.4.1, 13.2, 13.4.2, 15.4.4.2

**Written Interpretations**

4.2.11, 4.2.12

**Written Notice**

2.3, 2.4, 3.3.1, 3.9, 3.12.9, 3.12.10, 5.2.1, 8.2.2, 9.7, 9.10, 10.2.2, 10.3, 11.1.3, 11.4.6, 12.2.2, 12.2.4, **13.3**, 14, 15.4.1

**Written Orders**

1.1.1, 2.3, 3.9, 7, 8.2.2, 11.4.9, 12.1, 12.2, 13.5.2, 14.3.1, 15.1.2

Init.



## ARTICLE 1 GENERAL PROVISIONS

### § 1.1 BASIC DEFINITIONS

#### § 1.1.1 THE CONTRACT DOCUMENTS

The Contract Documents are enumerated in the Agreement between the Owner and Contractor (hereinafter the Agreement) and consist of the Agreement, Conditions of the Contract (General, Supplementary and other Conditions), Drawings, Specifications, Addenda issued prior to execution of the Contract, other documents listed in the Agreement and Modifications issued after execution of the Contract. A Modification is (1) a written amendment to the Contract signed by both parties, (2) a Change Order, (3) a Construction Change Directive or (4) a written order for a minor change in the Work issued by the Architect. Unless specifically enumerated in the Agreement, the Contract Documents do not include the advertisement or invitation to bid, Instructions to Bidders, sample forms, other information furnished by the Owner in anticipation of receiving bids or proposals, the Contractor's bid or proposal, or portions of Addenda relating to bidding requirements.

#### § 1.1.2 THE CONTRACT

The Contract Documents form the Contract for Construction. The Contract represents the entire and integrated agreement between the parties hereto and supersedes prior negotiations, representations or agreements, either written or oral. The Contract may be amended or modified only by a Modification. The Contract Documents shall not be construed to create a contractual relationship of any kind (1) between the Contractor and the Architect or the Architect's consultants, (2) between the Owner and a Subcontractor or a Sub-subcontractor, (3) between the Owner and the Architect or the Architect's consultants or (4) between any persons or entities other than the Owner and the Contractor. The Architect shall, however, be entitled to performance and enforcement of obligations under the Contract intended to facilitate performance of the Architect's duties.

#### § 1.1.3 THE WORK

The term "Work" means the construction and services required by the Contract Documents, whether completed or partially completed, and includes all other labor, materials, equipment and services provided or to be provided by the Contractor to fulfill the Contractor's obligations. The Work may constitute the whole or a part of the Project.

#### § 1.1.4 THE PROJECT

The Project is the total construction of which the Work performed under the Contract Documents may be the whole or a part and which may include construction by the Owner and by separate contractors.

#### § 1.1.5 THE DRAWINGS

The Drawings are the graphic and pictorial portions of the Contract Documents showing the design, location and dimensions of the Work, generally including plans, elevations, sections, details, schedules and diagrams.

#### § 1.1.6 THE SPECIFICATIONS

The Specifications are that portion of the Contract Documents consisting of the written requirements for materials, equipment, systems, standards and workmanship for the Work, and performance of related services.

#### § 1.1.7 INSTRUMENTS OF SERVICE

Instruments of Service are representations, in any medium of expression now known or later developed, of the tangible and intangible creative work performed by the Architect and the Architect's consultants under their respective professional services agreements. Instruments of Service may include, without limitation, studies, surveys, models, sketches, drawings, Project Manual, specifications, and other similar materials.

#### § 1.1.8 INITIAL DECISION MAKER

The Initial Decision Maker is the person identified in the Agreement to render initial decisions on Claims in accordance with Section 15.2 and certify termination of the Agreement under Section 14.2.2.

### § 1.2 CORRELATION AND INTENT OF THE CONTRACT DOCUMENTS

§ 1.2.1 The intent of the Contract Documents is to include all items necessary for the proper execution and completion of the Work by the Contractor. The Contract Documents are complementary, and what is required by one shall be as binding as if required by all; performance by the Contractor shall be required only to the extent consistent with the Contract Documents and reasonably inferable from them as being necessary to produce the indicated results.

§ 1.2.2 Organization of the Specifications into divisions, sections and articles, and arrangement of Drawings shall not control the Contractor in dividing the Work among Subcontractors or in establishing the extent of Work to be performed by any trade.

§ 1.2.3 Unless otherwise stated in the Contract Documents, words that have well-known technical or construction industry meanings are used in the Contract Documents in accordance with such recognized meanings.

### § 1.3 CAPITALIZATION

Terms capitalized in these General Conditions include those that are (1) specifically defined, (2) the titles of numbered articles or (3) the titles of other documents published by the American Institute of Architects.

### § 1.4 INTERPRETATION

In the interest of brevity the Contract Documents frequently omit modifying words such as "all" and "any" and articles such as "the" and "an," but the fact that a modifier or an article is absent from one statement and appears in another is not intended to affect the interpretation of either statement.

### § 1.5 OWNERSHIP AND USE OF DRAWINGS, SPECIFICATIONS AND OTHER INSTRUMENTS OF SERVICE

§ 1.5.1 The Architect and the Architect's consultants shall be deemed the authors and owners of their respective Instruments of Service, including the Drawings and Specifications, and will retain all common law, statutory and other reserved rights, including copyrights. The Contractor, Subcontractors, Sub-subcontractors, and material or equipment suppliers shall not own or claim a copyright in the Instruments of Service. Submittal or distribution to meet official regulatory requirements or for other purposes in connection with this Project is not to be construed as publication in derogation of the Architect's or Architect's consultants' reserved rights.

§ 1.5.2 The Contractor, Subcontractors, Sub-subcontractors and material or equipment suppliers are authorized to use and reproduce the Instruments of Service provided to them solely and exclusively for execution of the Work. All copies made under this authorization shall bear the copyright notice, if any, shown on the Instruments of Service. The Contractor, Subcontractors, Sub-subcontractors, and material or equipment suppliers may not use the Instruments of Service on other projects or for additions to this Project outside the scope of the Work without the specific written consent of the Owner, Architect and the Architect's consultants.

### § 1.6 TRANSMISSION OF DATA IN DIGITAL FORM

If the parties intend to transmit Instruments of Service or any other information or documentation in digital form, they shall endeavor to establish necessary protocols governing such transmissions, unless otherwise already provided in the Agreement or the Contract Documents.

## ARTICLE 2 OWNER

### § 2.1 GENERAL

§ 2.1.1 The Owner is the person or entity identified as such in the Agreement and is referred to throughout the Contract Documents as if singular in number. The Owner shall designate in writing a representative who shall have express authority to bind the Owner with respect to all matters requiring the Owner's approval or authorization. Except as otherwise provided in Section 4.2.1, the Architect does not have such authority. The term "Owner" means the Owner or the Owner's authorized representative.

§ 2.1.2 The Owner shall furnish to the Contractor within fifteen days after receipt of a written request, information necessary and relevant for the Contractor to evaluate, give notice of or enforce mechanic's lien rights. Such information shall include a correct statement of the record legal title to the property on which the Project is located, usually referred to as the site, and the Owner's interest therein.

### § 2.2 INFORMATION AND SERVICES REQUIRED OF THE OWNER

§ 2.2.1 Prior to commencement of the Work, the Contractor may request in writing that the Owner provide reasonable evidence that the Owner has made financial arrangements to fulfill the Owner's obligations under the Contract. Thereafter, the Contractor may only request such evidence if (1) the Owner fails to make payments to the Contractor as the Contract Documents require; (2) a change in the Work materially changes the Contract Sum; or (3) the Contractor identifies in writing a reasonable concern regarding the Owner's ability to make payment when due. The Owner shall furnish such evidence as a condition precedent to commencement or continuation of the Work or

init.

AIA Document A201™ - 2007. Copyright © 1911, 1915, 1918, 1925, 1937, 1951, 1958, 1961, 1963, 1966, 1970, 1976, 1987, 1997 and 2007 by The American Institute of Architects. All rights reserved. WARNING: This AIA® Document is protected by U.S. Copyright Law and International Treaties. Unauthorized reproduction or distribution of this AIA® Document, or any portion of it, may result in severe civil and criminal penalties, and will be prosecuted to the maximum extent possible under the law. This document was produced by AIA software at 15:13:02 on 07/19/2017 under Order No.7986168957\_1 which expires on 08/01/2017, and is not for resale.

User Notes:

(1383216234)

the portion of the Work affected by a material change. After the Owner furnishes the evidence, the Owner shall not materially vary such financial arrangements without prior notice to the Contractor.

§ 2.2.2 Except for permits and fees that are the responsibility of the Contractor under the Contract Documents, including those required under Section 3.7.1, the Owner shall secure and pay for necessary approvals, easements, assessments and charges required for construction, use or occupancy of permanent structures or for permanent changes in existing facilities.

§ 2.2.3 The Owner shall furnish surveys describing physical characteristics, legal limitations and utility locations for the site of the Project, and a legal description of the ~~site~~ site, as may be required. The Contractor shall be entitled to rely on the accuracy of information furnished by the Owner but shall exercise proper precautions relating to the safe performance of the Work.

§ 2.2.4 The Owner shall furnish information or services required of the Owner by the Contract Documents with reasonable promptness. The Owner shall also furnish any other information or services under the Owner's control and relevant to the Contractor's performance of the Work with reasonable promptness after receiving the Contractor's written request for such information or services.

§ 2.2.5 ~~Unless otherwise provided in the Contract Documents, the~~ The Owner shall furnish to the Contractor ~~one copy of the Contract Documents for purposes of making reproductions pursuant to Section 1.5.2, up to ten copies of the drawings and specifications as required for Contractor's execution of the Work. Any additional sets of documents that the contractor desires for construction of the Project will be issued to contractor at actual printing and handling costs.~~

### § 2.3 OWNER'S RIGHT TO STOP THE WORK

If the Contractor fails to correct Work that is not in accordance with the requirements of the Contract Documents as required by Section 12.2 or repeatedly fails to carry out Work in accordance with the Contract Documents, the Owner may issue a written order to the Contractor to stop the Work, or any portion thereof, until the cause for such order has been eliminated; however, the right of the Owner to stop the Work shall not give rise to a duty on the part of the Owner to exercise this right for the benefit of the Contractor or any other person or entity, except to the extent required by Section 6.1.3.

### § 2.4 OWNER'S RIGHT TO CARRY OUT THE WORK

If the Contractor defaults or neglects to carry out the Work in accordance with the Contract Documents and fails within a ten-day period after receipt of written notice from the Owner to commence and continue correction of such default or neglect with diligence and promptness, the Owner may, without prejudice to other remedies the Owner may have, correct such deficiencies. In such case an appropriate Change Order shall be issued deducting from payments then or thereafter due the Contractor the reasonable cost of correcting such deficiencies, including Owner's expenses and compensation for the Architect's additional services made necessary by such default, neglect or failure. Such action by the Owner and amounts charged to the Contractor are both subject to prior approval of the Architect. If payments then or thereafter due the Contractor are not sufficient to cover such amounts, the Contractor shall pay the difference to the Owner.

## ARTICLE 3 CONTRACTOR

### § 3.1 GENERAL

§ 3.1.1 The Contractor is the person or entity identified as such in the Agreement and is referred to throughout the Contract Documents as if singular in number. The Contractor shall be lawfully licensed, if required in the jurisdiction where the Project is located. The Contractor shall designate in writing a representative who shall have express authority to bind the Contractor with respect to all matters under this Contract. The term "Contractor" means the Contractor or the Contractor's authorized representative.

§ 3.1.2 The Contractor shall perform the Work in accordance with the Contract Documents.

§ 3.1.3 The Contractor shall not be relieved of obligations to perform the Work in accordance with the Contract Documents either by activities or duties of the Architect in the Architect's administration of the Contract, or by tests, inspections or approvals required or performed by persons or entities other than the Contractor.

Init.

AIA Document A201™ - 2007. Copyright © 1911, 1915, 1918, 1925, 1937, 1951, 1958, 1961, 1963, 1966, 1970, 1976, 1987, 1997 and 2007 by The American Institute of Architects. All rights reserved. WARNING: This AIA® Document is protected by U.S. Copyright Law and international Treaties. Unauthorized reproduction or distribution of this AIA® Document, or any portion of it, may result in severe civil and criminal penalties, and will be prosecuted to the maximum extent possible under the law. This document was produced by AIA software at 15:13:02 on 07/19/2017 under Order No.7986168957\_1 which expires on 08/01/2017, and is not for resale.

User Notes:

(1383216234)

### § 3.2 REVIEW OF CONTRACT DOCUMENTS AND FIELD CONDITIONS BY CONTRACTOR

§ 3.2.1 Execution of the Contract by the Contractor is a representation that the Contractor has visited the site, become generally familiar with local conditions under which the Work is to be performed and correlated personal observations with requirements of the Contract Documents.

§ 3.2.2 Because the Contract Documents are complementary, the Contractor shall, before starting each portion of the Work, carefully study and compare the various Contract Documents relative to that portion of the Work, as well as the information furnished by the Owner pursuant to Section 2.2.3, shall take field measurements of any existing conditions related to that portion of the Work, and shall observe any conditions at the site affecting it. These obligations are for the purpose of facilitating coordination and construction by the Contractor and are not for the purpose of discovering errors, omissions, or inconsistencies in the Contract Documents; however, the Contractor shall promptly report to the Architect any errors, inconsistencies or omissions discovered by or made known to the Contractor as a request for information in such form as the Architect may require. It is recognized that the Contractor's review is made in the Contractor's capacity as a contractor and not as a licensed design professional, unless otherwise specifically provided in the Contract Documents.

§ 3.2.3 The Contractor is not required to ascertain that the Contract Documents are in accordance with applicable laws, statutes, ordinances, codes, rules and regulations, or lawful orders of public authorities, but the Contractor shall promptly report to the Architect any nonconformity discovered by or made known to the Contractor as a request for information in such form as the Architect may require.

§ 3.2.4 If the Contractor believes that additional cost or time is involved because of clarifications or instructions the Architect issues in response to the Contractor's notices or requests for information pursuant to Sections 3.2.2 or 3.2.3, the Contractor shall make Claims as provided in Article 15. If the Contractor fails to perform the obligations of Sections 3.2.2 or 3.2.3, the Contractor shall pay such costs and damages to the Owner as would have been avoided if the Contractor had performed such obligations. If the Contractor performs those obligations, the Contractor shall not be liable to the Owner or Architect for damages resulting from errors, inconsistencies or omissions in the Contract Documents, for differences between field measurements or conditions and the Contract Documents, or for nonconformities of the Contract Documents to applicable laws, statutes, ordinances, codes, rules and regulations, and lawful orders of public authorities.

### § 3.3 SUPERVISION AND CONSTRUCTION PROCEDURES

§ 3.3.1 The Contractor shall supervise and direct the Work, using the Contractor's best skill and attention. The Contractor shall be solely responsible for, and have control over, construction means, methods, techniques, sequences and procedures and for coordinating all portions of the Work under the Contract, unless the Contract Documents give other specific instructions concerning these matters. If the Contract Documents give specific instructions concerning construction means, methods, techniques, sequences or procedures, the Contractor shall evaluate the jobsite safety thereof and, except as stated below, shall be fully and solely responsible for the jobsite safety of such means, methods, techniques, sequences or procedures. If the Contractor determines that such means, methods, techniques, sequences or procedures may not be safe, the Contractor shall give timely written notice to the Owner and Architect and shall not proceed with that portion of the Work without further written instructions from the Architect. If the Contractor is then instructed to proceed with the required means, methods, techniques, sequences or procedures without acceptance of changes proposed by the Contractor, the Owner shall be solely responsible for any loss or damage arising solely from those Owner-required means, methods, techniques, sequences or procedures.

§ 3.3.2 The Contractor shall be responsible to the Owner for acts and omissions of the Contractor's employees, Subcontractors and their agents and employees, and other persons or entities performing portions of the Work for, or on behalf of, the Contractor or any of its Subcontractors.

§ 3.3.3 The Contractor shall be responsible for inspection of portions of Work already performed to determine that such portions are in proper condition to receive subsequent Work.

3.3.4 Three (3) days after the opening of the Bids, the Contractor shall furnish for written approval, an outline of the education, experience and character of the Contractor's project manager, superintendent and engineer. Any future substitution must have prior written approval of the Architect.

Init.

### § 3.4 LABOR AND MATERIALS

§ 3.4.1 Unless otherwise provided in the Contract Documents, the Contractor shall provide and pay for labor, materials, equipment, tools, construction equipment and machinery, water, heat, utilities, transportation, and other facilities and services necessary for proper execution and completion of the Work, whether temporary or permanent and whether or not incorporated or to be incorporated in the Work.

§ 3.4.2 Except in the case of minor changes in the Work authorized by the Architect in accordance with Sections 3.12.8 or 7.4, the Contractor may make substitutions only with the consent of the Owner, after evaluation by the Architect and in accordance with a Change Order or Construction Change Directive.

§ 3.4.3 The Contractor shall enforce strict discipline and good order among the Contractor's employees and other persons carrying out the Work. The Contractor shall not permit employment of unfit persons or persons not properly skilled in tasks assigned to ~~them~~them.

3.4.4 The Contractor's or his Subcontractor's supervisors and workmen engaged on special work or skilled Work in any supervisory position or trade shall be qualified and have had sufficient education, training and experience as a recognized professional or master mechanic in such Work to perform it properly and satisfactorily as prescribed in the Contract Documents.

3.4.5 Any project manager, superintendent, engineer, foreman or workman employed by the Contractor or by a subcontractor who, in the sole opinion of the Architect, does not perform his Work in a proper and skillful manner or becomes party to disrespectful, intemperate, disorderly, intoxicated, or dishonest behavior, or uses foul language, fights, commits criminal act(s) falsifies records and construction, covers-up faulty Work or materials, does not comprehend or follow instructions, does not get along with the Architect or Owner's representative, or is otherwise objectionable, shall, at the written request by the Architect, be discharged 24 hours by the Contractor or Subcontractor employing such project manager, superintendent, engineer, foreman or workman, and shall not be employed again or any portion of the Work without the written consent of the Architect.

3.4.6 Should the Contractor fail to remove such person or persons specified in Article 3.4.5 hereinabove or fail to furnish suitable and sufficient machinery, equipment, materials or qualified labor force for the proper execution of the Work, the Architect may withhold all payments which are or may become due the Contractor or may suspend the Work until such orders are complied with.

3.4.7 Contractor shall abide by provisions of Section 14-1 and Section 14.2, Code of the City of Mobile, originally adopted December 10, 1991. Prohibiting Discrimination in Employment by Contractors, Subcontractors and Vendors performing Work and providing materials and supplies for the City of Mobile. A copy of said Code is located in the City's Projects Architectural Engineering Department. Certification of compliance with this requirement shall be made for all persons involved in the Work by the signature of the General Contractor on the Bid Form (Section 00410).

### § 3.5 WARRANTY

The Contractor warrants to the Owner and Architect that materials and equipment furnished under the Contract will be of good quality and new unless the Contract Documents require or permit otherwise. The Contractor further warrants that the Work will conform to the requirements of the Contract Documents and will be free from defects, except for those inherent in the quality of the Work the Contract Documents require or permit. Work, materials, or equipment not conforming to these requirements may be considered defective. The Contractor's warranty excludes remedy for damage or defect caused by abuse, alterations to the Work not executed by the Contractor, improper or insufficient maintenance, improper operation, or normal wear and tear and normal usage. If required by the Architect, the Contractor shall furnish satisfactory evidence as to the kind and quality of materials and equipment.

### § 3.6 TAXES

The Contractor shall pay sales, consumer, use and similar taxes for the Work provided by the Contractor that are legally enacted when bids are received or negotiations concluded, whether or not yet effective or merely scheduled to go into effect.

~~§ 3.7 PERMITS, FEES, NOTICES AND COMPLIANCE WITH LAWS~~  
**PERMITS, FEES, NOTICES, AND COMPLIANCE WITH LAWS**

~~§ 3.7.1 Unless otherwise provided in the Contract Documents, the Contractor shall secure and pay for the building permit as well as for City of Mobile building permit without cost, and shall secure and pay for other permits, fees, licenses, and inspections by government agencies necessary for proper execution and completion of the Work that are customarily secured after execution of the Contract and legally required at the time bids are received or negotiations concluded.~~

~~3.7.1.1 The Contractor shall secure building and other permits customarily obtained from the City of Mobile at no cost.~~

§ 3.7.2 The Contractor shall comply with and give notices required by applicable laws, statutes, ordinances, codes, rules and regulations, and lawful orders of public authorities applicable to performance of the Work.

§ 3.7.3 If the Contractor performs Work knowing it to be contrary to applicable laws, statutes, ordinances, codes, rules and regulations, or lawful orders of public authorities, the Contractor shall assume appropriate responsibility for such Work and shall bear the costs attributable to correction.

§ 3.7.4 **Concealed or Unknown Conditions.** If the Contractor encounters conditions at the site that are (1) subsurface or otherwise concealed physical conditions that differ materially from those indicated in the Contract Documents or (2) unknown physical conditions of an unusual nature, that differ materially from those ordinarily found to exist and generally recognized as inherent in construction activities of the character provided for in the Contract Documents, the Contractor shall promptly provide notice to the Owner and the Architect before conditions are disturbed and in no event later than 21 days after first observance of the conditions. The Architect will promptly investigate such conditions and, if the Architect determines that they differ materially and cause an increase or decrease in the Contractor's cost of, or time required for, performance of any part of the Work, will recommend an equitable adjustment in the Contract Sum or Contract Time, or both. If the Architect determines that the conditions at the site are not materially different from those indicated in the Contract Documents and that no change in the terms of the Contract is justified, the Architect shall promptly notify the Owner and Contractor in writing, stating the reasons. If either party disputes the Architect's determination or recommendation, that party may proceed as provided in Article 15.

§ 3.7.5 If, in the course of the Work, the Contractor encounters human remains or recognizes the existence of burial markers, archaeological sites or wetlands not indicated in the Contract Documents, the Contractor shall immediately suspend any operations that would affect them and shall notify the Owner and Architect. Upon receipt of such notice, the Owner shall promptly take any action necessary to obtain governmental authorization required to resume the operations. The Contractor shall continue to suspend such operations until otherwise instructed by the Owner but shall continue with all other operations that do not affect those remains or features. Requests for adjustments in the Contract Sum and Contract Time arising from the existence of such remains or features may be made as provided in Article 15.

**§ 3.8 ALLOWANCES**

~~§ 3.8.1~~ The Contractor shall include in the Contract Sum all allowances stated in the Contract Documents. Items covered by allowances shall be supplied for such amounts and by such persons or entities as the Owner may direct, but the Contractor shall not be required to employ persons or entities to whom the Contractor has reasonable objection.

§ 3.8.2 Unless otherwise provided in the Contract Documents,

1. ~~Allowances-allowances~~ shall cover the cost to the Contractor of materials and equipment delivered at the site and all required taxes, less applicable trade discounts;
2. Contractor's costs for unloading and handling at the site, labor, installation costs, overhead, profit and other expenses contemplated for stated allowance amounts shall be included in the Contract Sum but not in the allowances; and
3. ~~Whenever whenever~~ costs are more than or less than allowances, the Contract Sum shall be adjusted accordingly by Change Order. The amount of the Change Order shall reflect (1) the difference between actual costs and the allowances under Section 3.8.2.1 and (2) changes in Contractor's costs under Section 3.8.2.2.

init.

§ 3.8.3 Materials and equipment under an allowance shall be selected by the Owner with reasonable promptness.

### § 3.9 SUPERINTENDENT

§ 3.9.1 The Contractor shall employ a competent superintendent and necessary assistants who shall be in attendance at the Project site during performance of the Work. The superintendent shall represent the Contractor, and communications given to the superintendent shall be as binding as if given to the Contractor.

§ 3.9.2 The Contractor, as soon as practicable after award of the Contract, shall furnish in writing to the Owner through the Architect the name and qualifications of a proposed superintendent. The Architect may reply within 14 days to the Contractor in writing stating (1) whether the Owner or the Architect has reasonable objection to the proposed superintendent or (2) that the Architect requires additional time to review. Failure of the Architect to reply within the 14 day period shall constitute notice of no reasonable objection.

§ 3.9.3 The Contractor shall not employ a proposed superintendent to whom the Owner or Architect has made reasonable and timely objection. The Contractor shall not change the superintendent without the Owner's consent, which shall not unreasonably be withheld or delayed.

### § 3.10 CONTRACTOR'S CONSTRUCTION SCHEDULES

§ 3.10.1 The Contractor, promptly within ten (10) business days after being awarded the Contract, shall prepare and submit for the Owner's and Architect's information a Contractor's construction schedule for the Work. The schedule shall not exceed time limits current under the Contract Documents, shall be revised at appropriate intervals as required by the conditions of the Work and Project, shall be related to the entire Project to the extent required by the Contract Documents, and shall provide for expeditious and practicable execution of the Work.

§ 3.10.2 The Contractor shall prepare a submittal schedule, promptly after being awarded the Contract and thereafter as necessary to maintain a current submittal schedule, and shall submit the schedule(s) for the Architect's approval. The Architect's approval shall not unreasonably be delayed or withheld. The submittal schedule shall (1) be coordinated with the Contractor's construction schedule, and (2) allow the Architect reasonable time to review submittals. If the Contractor fails to submit a submittal schedule, the Contractor shall not be entitled to any increase in Contract Sum or extension of Contract Time based on the time required for review of submittals.

§ 3.10.3 The Contractor shall perform the Work in general accordance with the most recent schedules submitted to the Owner and Architect.

### § 3.11 DOCUMENTS AND SAMPLES AT THE SITE

The Contractor shall maintain at the site for the Owner one copy of the Drawings, Specifications, Addenda, Change Orders and other Modifications, in good order and marked currently to indicate field changes and selections made during construction, and one copy of approved Shop Drawings, Product Data, Samples and similar required submittals. These shall be available to the Architect and shall be delivered to the Architect for submittal to the Owner upon completion of the Work as a record of the Work as constructed.

### § 3.12 SHOP DRAWINGS, PRODUCT DATA AND SAMPLES

§ 3.12.1 Shop Drawings are drawings, diagrams, schedules and other data specially prepared for the Work by the Contractor or a Subcontractor, Sub-subcontractor, manufacturer, supplier or distributor to illustrate some portion of the Work.

§ 3.12.2 Product Data are illustrations, standard schedules, performance charts, instructions, brochures, diagrams and other information furnished by the Contractor to illustrate materials or equipment for some portion of the Work.

§ 3.12.3 Samples are physical examples that illustrate materials, equipment or workmanship and establish standards by which the Work will be judged.

§ 3.12.4 Shop Drawings, Product Data, Samples and similar submittals are not Contract Documents. Their purpose is to demonstrate the way by which the Contractor proposes to conform to the information given and the design concept expressed in the Contract Documents for those portions of the Work for which the Contract Documents require submittals. Review by the Architect is subject to the limitations of Section 4.2.7. Informational submittals

Init.

AIA Document A201™ – 2007. Copyright © 1911, 1915, 1918, 1925, 1937, 1951, 1958, 1961, 1963, 1966, 1970, 1976, 1987, 1997 and 2007 by The American Institute of Architects. All rights reserved. WARNING: This AIA® Document is protected by U.S. Copyright Law and International Treaties. Unauthorized reproduction or distribution of this AIA® Document, or any portion of it, may result in severe civil and criminal penalties, and will be prosecuted to the maximum extent possible under the law. This document was produced by AIA software at 15:13:02 on 07/19/2017 under Order No.7986168957\_1 which expires on 08/01/2017, and is not for resale.

User Notes:

(1383216234)



upon which the Architect is not expected to take responsive action may be so identified in the Contract Documents. Submittals that are not required by the Contract Documents may be returned by the Architect without action.

**§ 3.12.5** The Contractor shall review for compliance with the Contract Documents, approve and submit to the Architect Shop Drawings, Product Data, Samples and similar submittals required by the Contract Documents ~~in accordance with the submittal schedule approved by the Architect or, in the absence of an approved submittal schedule,~~ with reasonable promptness and in such sequence as to cause no delay in the Work or in the activities of the Owner or of separate contractors. Submittals which are not marked as reviewed for compliance with the Contract Documents and approved by the Contractor may be returned by the Architect without action. Wherever Shop Drawings are required in these Specifications, Shop Drawings shall be submitted for approval before materials are fabricated. Drawings shall show complete details. The General Contractor shall check and approve them either in writing or by stamp before forwarding to the Architect. The Architect will mark copies "Approved" if correct; or "Approved As Noted" if only minor corrections are necessary. If major corrections are necessary they will be noted on the Shop Drawings and they will be returned to the Contractor for correction and resubmission. Submit four (4) copies for Architect's and Owner's use plus the number of copies the contractor requires for his own use.

**§ 3.12.6** By submitting Shop Drawings, Product Data, Samples and similar submittals, the Contractor represents to the Owner and Architect that the Contractor has (1) reviewed and approved them, (2) determined and verified materials, field measurements and field construction criteria related thereto, or will do so and (3) checked and coordinated the information contained within such submittals with the requirements of the Work and of the Contract Documents.

**§ 3.12.7** The Contractor shall perform no portion of the Work for which the Contract Documents require submittal and review of Shop Drawings, Product Data, Samples or similar submittals until the respective submittal has been approved by the Architect.

**§ 3.12.8** The Work shall be in accordance with approved submittals except that the Contractor shall not be relieved of responsibility for deviations from requirements of the Contract Documents by the Architect's approval of Shop Drawings, Product Data, Samples or similar submittals unless the Contractor has specifically informed the Architect in writing of such deviation at the time of submittal and (1) the Architect has given written approval to the specific deviation as a minor change in the Work, or (2) a Change Order or Construction Change Directive has been issued authorizing the deviation. The Contractor shall not be relieved of responsibility for errors or omissions in Shop Drawings, Product Data, Samples or similar submittals by the Architect's approval thereof.

**§ 3.12.9** The Contractor shall direct specific attention, in writing or on resubmitted Shop Drawings, Product Data, Samples or similar submittals, to revisions other than those requested by the Architect on previous submittals. In the absence of such written notice, the Architect's approval of a resubmission shall not apply to such revisions.

**§ 3.12.10** The Contractor shall not be required to provide professional services that constitute the practice of architecture or engineering unless such services are specifically required by the Contract Documents for a portion of the Work or unless the Contractor needs to provide such services in order to carry out the Contractor's responsibilities for construction means, methods, techniques, sequences and procedures. The Contractor shall not be required to provide professional services in violation of applicable law. If professional design services or certifications by a design professional related to systems, materials or equipment are specifically required of the Contractor by the Contract Documents, the Owner and the Architect will specify all performance and design criteria that such services must satisfy. The Contractor shall cause such services or certifications to be provided by a properly licensed design professional, whose signature and seal shall appear on all drawings, calculations, specifications, certifications, Shop Drawings and other submittals prepared by such professional. Shop Drawings and other submittals related to the Work designed or certified by such professional, if prepared by others, shall bear such professional's written approval when submitted to the Architect. The Owner and the Architect shall be entitled to rely upon the adequacy, accuracy and completeness of the services, certifications and approvals performed or provided by such design professionals, provided the Owner and Architect have specified to the Contractor all performance and design criteria that such services must satisfy. Pursuant to this Section 3.12.10, the Architect will review, approve or take other appropriate action on submittals only for the limited purpose of checking for conformance with information given and the design concept expressed in the Contract Documents. The Contractor

Int.



shall not be responsible for the adequacy of the performance and design criteria specified in the Contract Documents.

### § 3.13 USE OF SITE

The Contractor shall confine operations at the site to areas permitted by applicable laws, statutes, ordinances, codes, rules and regulations, and lawful orders of public authorities and the Contract Documents and shall not unreasonably encumber the site with materials or equipment.

### § 3.14 CUTTING AND PATCHING

§ 3.14.1 The Contractor shall be responsible for cutting, fitting or patching required to complete the Work or to make its parts fit together properly. All areas requiring cutting, fitting and patching shall be restored to the condition existing prior to the cutting, fitting and patching, unless otherwise required by the Contract Documents.

§ 3.14.2 The Contractor shall not damage or endanger a portion of the Work or fully or partially completed construction of the Owner or separate contractors by cutting, patching or otherwise altering such construction, or by excavation. The Contractor shall not cut or otherwise alter such construction by the Owner or a separate contractor except with written consent of the Owner and of such separate contractor; such consent shall not be unreasonably withheld. The Contractor shall not unreasonably withhold from the Owner or a separate contractor the Contractor's consent to cutting or otherwise altering the Work.

### § 3.15 CLEANING UP

§ 3.15.1 The Contractor shall keep the premises and surrounding area free from accumulation of waste materials or rubbish caused by operations under the Contract. At completion of the Work, the Contractor shall remove waste materials, rubbish, the Contractor's tools, construction equipment, machinery and surplus materials from and about the Project.

§ 3.15.2 If the Contractor fails to clean up as provided in the Contract Documents, the Owner may do so and Owner shall be entitled to reimbursement from the Contractor.

### § 3.16 ACCESS TO WORK

The Contractor shall provide the Owner and Architect access to the Work in preparation and progress wherever located.

### § 3.17 ROYALTIES, PATENTS AND COPYRIGHTS

The Contractor shall pay all royalties and license fees. The Contractor shall defend suits or claims for infringement of copyrights and patent rights and shall hold the Owner and Architect harmless from loss on account thereof, but shall not be responsible for such defense or loss when a particular design, process or product of a particular manufacturer or manufacturers is required by the Contract Documents, or where the copyright violations are contained in Drawings, Specifications or other documents prepared by the Owner or Architect. However, if the Contractor has reason to believe that the required design, process or product is an infringement of a copyright or a patent, the Contractor shall be responsible for such loss unless such information is promptly furnished to the Architect.

### § 3.18 INDEMNIFICATION

§ 3.18.1 To the fullest extent permitted by law the Contractor shall indemnify and hold harmless the Owner, Architect, Architect's consultants, and agents and employees of any of them from and against claims, damages, losses and expenses, including but not limited to attorneys' fees, arising out of or resulting from performance of the Work, provided that such claim, damage, loss or expense is attributable to bodily injury, sickness, disease or death, or to injury to or destruction of tangible property (other than the Work itself), but only to the extent caused by the negligent acts or omissions of the Contractor, a Subcontractor, anyone directly or indirectly employed by them or anyone for whose acts they may be liable, regardless of whether or not such claim, damage, loss or expense is caused in part by a party indemnified hereunder. Such obligation shall not be construed to negate, abridge, or reduce other rights or obligations of indemnity that which would otherwise exist as to a party or person described in this Section 3.18.

§ 3.18.2 In claims against any person or entity indemnified under this Section 3.18 by an employee of the Contractor, a Subcontractor, anyone directly or indirectly employed by them or anyone for whose acts they may be

Init.

AIA Document A201™ - 2007. Copyright © 1911, 1915, 1918, 1925, 1937, 1951, 1958, 1961, 1963, 1966, 1970, 1976, 1987, 1997 and 2007 by The American Institute of Architects. All rights reserved. WARNING: This AIA® Document is protected by U.S. Copyright Law and International Treaties. Unauthorized reproduction or distribution of this AIA® Document, or any portion of it, may result in severe civil and criminal penalties, and will be prosecuted to the maximum extent possible under the law. This document was produced by AIA software at 15:13:02 on 07/19/2017 under Order No.7986168957\_1 which expires on 08/01/2017, and is not for resale.

User Notes:

(1383216234)

liable, the indemnification obligation under Section 3.18.1 shall not be limited by a limitation on amount or type of damages, compensation or benefits payable by or for the Contractor or a Subcontractor under workers' compensation acts, disability benefit acts or other employee benefit acts.

3.19 As applicable, the Contractor shall be responsible at the appropriate time during construction of the Project to have all permanent meters installed (electrical, water, gas, etc.) and all utilities connected prior to the time of Final Inspection. The Contractor shall pay all utilities costs until the Project is accepted by the City of Mobile.

#### ARTICLE 4 ARCHITECT

##### § 4.1 GENERAL

§ 4.1.1 The Owner shall retain an architect lawfully licensed to practice architecture or an entity lawfully practicing architecture in the jurisdiction where the Project is located. That person or entity is identified as the Architect in the Agreement and is referred to throughout the Contract Documents as if singular in number. "Architect" may also designate the Licensed Designer of the Project and may be an Engineer or Landscape Architect.

§ 4.1.2 Duties, responsibilities and limitations of authority of the Architect as set forth in the Contract Documents shall not be restricted, modified or extended without written consent of the Owner, Contractor and Architect. Consent shall not be unreasonably withheld.

§ 4.1.3 If the employment of the Architect is terminated, the Owner shall employ a successor architect as to whom the Contractor has no reasonable objection and whose status under the Contract Documents shall be that of the Architect.

##### § 4.2 ADMINISTRATION OF THE CONTRACT

§ 4.2.1 The Architect will provide administration of the Contract as described in the Contract Documents and will be an Owner's representative ~~during construction until the date the Architect issues the final Certificate for Payment.~~ (1) during construction (2) until all conditions necessary for the final completion and payment have been fulfilled and (3) with the Owner's concurrence, from time to time during the one-year period for correction of Work described in Section 12.2. The Architect will have authority to act on behalf of the Owner only to the extent provided in the ~~Contract Documents.~~ Documents, unless otherwise modified in writing in accordance with other provisions of the Contract.

§ 4.2.2 The Architect will visit the site at intervals appropriate to the stage of construction, or as otherwise agreed with the Owner, to become generally familiar with the progress and quality of the portion of the Work completed, and to determine in general if the Work observed is being performed in a manner indicating that the Work, when fully completed, will be in accordance with the Contract Documents. However, the Architect will not be required to make exhaustive or continuous on-site inspections to check the quality or quantity of the Work. The Architect will not have control over, charge of, or responsibility for, the construction means, methods, techniques, sequences or procedures, or for the safety precautions and programs in connection with the Work, since these are solely the Contractor's rights and responsibilities under the Contract Documents, except as provided in Section 3.3.1.

§ 4.2.3 On the basis of the site visits, the Architect will keep the Owner reasonably informed about the progress and quality of the portion of the Work completed, and report to the Owner (1) known deviations from the Contract Documents and from the most recent construction schedule submitted by the Contractor, and (2) defects and deficiencies observed in the Work. The Architect will not be responsible for the Contractor's failure to perform the Work in accordance with the requirements of the Contract Documents. The Architect will not have control over or charge of and will not be responsible for acts or omissions of the Contractor, Subcontractors, or their agents or employees, or any other persons or entities performing portions of the Work.

##### § 4.2.4 COMMUNICATIONS FACILITATING CONTRACT ADMINISTRATION

Except as otherwise provided in the Contract Documents or when direct communications have been specially authorized, the Owner and Contractor shall endeavor to communicate with each other through the Architect about matters arising out of or relating to the Contract. Communications by and with the Architect's consultants shall be through the Architect. Communications by and with Subcontractors and material suppliers shall be through the Contractor. Communications by and with separate contractors shall be through the Owner.

Init.

AIA Document A201™ - 2007. Copyright © 1911, 1915, 1918, 1925, 1937, 1951, 1958, 1961, 1963, 1966, 1970, 1976, 1987, 1997 and 2007 by The American Institute of Architects. All rights reserved. WARNING: This AIA® Document is protected by U.S. Copyright Law and International Treaties. Unauthorized reproduction or distribution of this AIA® Document, or any portion of it, may result in severe civil and criminal penalties, and will be prosecuted to the maximum extent possible under the law. This document was produced by AIA software at 15:13:02 on 07/19/2017 under Order No.7986168957\_1 which expires on 08/01/2017, and is not for resale.

User Notes:

(1383216234)

§ 4.2.5 Based on the Architect's evaluations of the Contractor's Applications for Payment, the Architect will review and certify the amounts due the Contractor and will issue Certificates for Payment in such amounts.

§ 4.2.6 The Architect has authority to reject Work that does not conform to the Contract Documents. Whenever the Architect considers it necessary or advisable, the Architect will have authority to require inspection or testing of the Work in accordance with Sections 13.5.2 and 13.5.3, whether or not such Work is fabricated, installed or completed. However, neither this authority of the Architect nor a decision made in good faith either to exercise or not to exercise such authority shall give rise to a duty or responsibility of the Architect to the Contractor, Subcontractors, material and equipment suppliers, their agents or employees, or other persons or entities performing portions of the Work.

§ 4.2.7 The Architect will review and approve, or take other appropriate action upon, the Contractor's submittals such as Shop Drawings, Product Data and Samples, but only for the limited purpose of checking for conformance with information given and the design concept expressed in the Contract Documents. The Architect's action will be taken in accordance with the submittal schedule approved by the Architect or, in the absence of an approved submittal schedule, with reasonable promptness while allowing sufficient time in the Architect's professional judgment to permit adequate review. Review of such submittals is not conducted for the purpose of determining the accuracy and completeness of other details such as dimensions and quantities, or for substantiating instructions for installation or performance of equipment or systems, all of which remain the responsibility of the Contractor as required by the Contract Documents. The Architect's review of the Contractor's submittals shall not relieve the Contractor of the obligations under Sections 3.3, 3.5 and 3.12. The Architect's review shall not constitute approval of safety precautions or, unless otherwise specifically stated by the Architect, of any construction means, methods, techniques, sequences or procedures. The Architect's approval of a specific item shall not indicate approval of an assembly of which the item is a component.

§ 4.2.8 The Architect will prepare Change Orders and Construction Change Directives, and may authorize minor changes in the Work as provided in Section 7.4. The Architect will investigate and make determinations and recommendations regarding concealed and unknown conditions as provided in Section 3.7.4.

§ 4.2.9 The Architect will conduct inspections to determine the date or dates of Substantial Completion and the date of final completion; issue Certificates of Substantial Completion pursuant to Section 9.8; receive and forward to the Owner, for the Owner's review and records, written warranties and related documents required by the Contract and assembled by the Contractor pursuant to Section 9.10; and issue a final Certificate for Payment pursuant to Section 9.10.

§ 4.2.10 If the Owner and Architect agree, the Architect will provide one or more project representatives to assist in carrying out the Architect's responsibilities at the site. The duties, responsibilities and limitations of authority of such project representatives shall be as set forth in an exhibit to be incorporated in the Contract Documents.

§ 4.2.11 The Architect will interpret and decide matters concerning performance under, and requirements of, the Contract Documents on written request of either the Owner or Contractor. The Architect's response to such requests will be made in writing within any time limits agreed upon or otherwise with reasonable promptness.

§ 4.2.12 Interpretations and decisions of the Architect will be consistent with the intent of, and reasonably inferable from, the Contract Documents and will be in writing or in the form of drawings. When making such interpretations and decisions, the Architect will endeavor to secure faithful performance by both Owner and Contractor, will not show partiality to either and will not be liable for results of interpretations or decisions rendered in good faith.

§ 4.2.13 The Architect's decisions on matters relating to aesthetic effect will be final if consistent with the intent expressed in the Contract Documents.

§ 4.2.14 The Architect will review and respond to requests for information about the Contract Documents. The Architect's response to such requests will be made in writing within any time limits agreed upon or otherwise with reasonable promptness. If appropriate, the Architect will prepare and issue supplemental Drawings and Specifications in response to the requests for information.

## ARTICLE 5 SUBCONTRACTORS

### § 5.1 DEFINITIONS

§ 5.1.1 A Subcontractor is a person or entity who has a direct contract with the Contractor to perform a portion of the Work at the site. The term "Subcontractor" is referred to throughout the Contract Documents as if singular in number and means a Subcontractor or an authorized representative of the Subcontractor. The term "Subcontractor" does not include a separate contractor or subcontractors of a separate contractor.

§ 5.1.2 A Sub-subcontractor is a person or entity who has a direct or indirect contract with a Subcontractor to perform a portion of the Work at the site. The term "Sub-subcontractor" is referred to throughout the Contract Documents as if singular in number and means a Sub-subcontractor or an authorized representative of the Sub-subcontractor.

### § 5.2 AWARD OF SUBCONTRACTS AND OTHER CONTRACTS FOR PORTIONS OF THE WORK

§ 5.2.1 ~~Unless otherwise stated in the Contract Documents or the bidding requirements, the Contractor, as soon as practicable after award of the Contract, The apparent low bidder, within (3) days after bids are opened shall furnish in writing to the Owner through the Architect the names of persons or entities (including those who are to furnish materials or equipment fabricated to a special design) proposed for each principal portion of the Work. The Architect may reply within 14 days to the Contractor in writing stating (1) whether the Owner or the Architect has reasonable objection to any such proposed person or entity or (2) that the Architect requires additional time for review. Failure of the Owner or Architect to reply within the 14-day-14 day period shall constitute notice of no reasonable objection.~~

§ 5.2.2 The Contractor shall not contract with a proposed person or entity to whom the Owner or Architect has made reasonable and timely objection. The Contractor shall not be required to contract with anyone to whom the Contractor has made reasonable objection.

§ 5.2.3 ~~If the Owner or Architect has reasonable objection to a person or entity proposed by the Contractor, the Contractor shall propose another to whom the Owner or Architect has no reasonable objection. If the proposed but rejected Subcontractor was reasonably capable of performing the Work, the Contract Sum and Contract Time shall be increased or decreased by the difference, if any, occasioned by such change, and an appropriate Change Order shall be issued before commencement of the substitute Subcontractor's Work. However, no increase in the Contract Sum or Contract Time shall be allowed for such change unless the Contractor has acted promptly and responsibly in submitting names as required.~~

§ 5.2.4 The Contractor shall not substitute a Subcontractor, person or entity previously selected if the Owner or Architect makes reasonable objection to such substitution.

### § 5.3 SUBCONTRACTUAL RELATIONS

By appropriate agreement, written where legally required for validity, the Contractor shall require each Subcontractor, to the extent of the Work to be performed by the Subcontractor, to be bound to the Contractor by terms of the Contract Documents, and to assume toward the Contractor all the obligations and responsibilities, including the responsibility for safety of the Subcontractor's Work, which the Contractor, by these Documents, assumes toward the Owner and Architect. Each subcontract agreement shall preserve and protect the rights of the Owner and Architect under the Contract Documents with respect to the Work to be performed by the Subcontractor so that subcontracting thereof will not prejudice such rights, and shall allow to the Subcontractor, unless specifically provided otherwise in the subcontract agreement, the benefit of all rights, remedies and redress against the Contractor that the Contractor, by the Contract Documents, has against the Owner. Where appropriate, the Contractor shall require each Subcontractor to enter into similar agreements with Sub-subcontractors. The Contractor shall make available to each proposed Subcontractor, prior to the execution of the subcontract agreement, copies of the Contract Documents to which the Subcontractor will be bound, and, upon written request of the Subcontractor, identify to the Subcontractor terms and conditions of the proposed subcontract agreement that may be at variance with the Contract Documents. Subcontractors will similarly make copies of applicable portions of such documents available to their respective proposed Sub-subcontractors.

### § 5.4 CONTINGENT ASSIGNMENT OF SUBCONTRACTS

§ 5.4.1 Each subcontract agreement for a portion of the Work is assigned by the Contractor to the Owner, provided that

Init. AIA Document A201™ - 2007. Copyright © 1911, 1915, 1918, 1925, 1937, 1951, 1958, 1961, 1963, 1966, 1970, 1976, 1987, 1997 and 2007 by The American Institute of Architects. All rights reserved. WARNING: This AIA® Document is protected by U.S. Copyright Law and international Treaties. Unauthorized reproduction or distribution of this AIA® Document, or any portion of it, may result in severe civil and criminal penalties, and will be prosecuted to the maximum extent possible under the law. This document was produced by AIA software at 15:13:02 on 07/19/2017 under Order No.7986168957\_1 which expires on 08/01/2017, and is not for resale.

User Notes:

(1383216234)

- .1 assignment is effective only after termination of the Contract by the Owner for cause pursuant to Section 14.2 and only for those subcontract agreements that the Owner accepts by notifying the Subcontractor and Contractor in writing; and
- .2 assignment is subject to the prior rights of the surety, if any, obligated under bond relating to the Contract.

When the Owner accepts the assignment of a subcontract agreement, the Owner assumes the Contractor's rights and obligations under the subcontract.

§ 5.4.2 Upon such assignment, if the Work has been suspended for more than 30 days, the Subcontractor's compensation shall may be equitably adjusted for increases in cost resulting from the suspension.

§ 5.4.3 Upon such assignment to the Owner under this Section 5.4, the Owner may further assign the subcontract to a successor contractor or other entity. ~~If the Owner assigns the subcontract to a successor contractor or other entity, the Owner shall nevertheless remain legally responsible for all of the successor contractor's obligations under the subcontract.~~

## ARTICLE 6 CONSTRUCTION BY OWNER OR BY SEPARATE CONTRACTORS

### § 6.1 OWNER'S RIGHT TO PERFORM CONSTRUCTION AND TO AWARD SEPARATE CONTRACTS

§ 6.1.1 The Owner reserves the right to perform construction or operations related to the Project with the Owner's own forces, and to award separate contracts in connection with other portions of the Project or other construction or operations on the site under Conditions of the Contract identical or substantially similar to these including those portions related to insurance and waiver of subrogation. If the Contractor claims that delay or additional cost is involved because of such action by the Owner, the Contractor shall make such Claim as provided in Article 15.

§ 6.1.2 When separate contracts are awarded for different portions of the Project or other construction or operations on the site, the term "Contractor" in the Contract Documents in each case shall mean the Contractor who executes each separate Owner-Contractor Agreement.

§ 6.1.3 The Owner shall provide for coordination of the activities of the Owner's own forces and of each separate contractor with the Work of the Contractor, who shall cooperate with them. The Contractor shall participate with other separate contractors and the Owner in reviewing their construction schedules. The Contractor shall make any revisions to the construction schedule deemed necessary after a joint review and mutual agreement. The construction schedules shall then constitute the schedules to be used by the Contractor, separate contractors and the Owner until subsequently revised.

§ 6.1.4 Unless otherwise provided in the Contract Documents, when the Owner performs construction or operations related to the Project with the Owner's own forces, the Owner shall be deemed to be subject to the same obligations and to have the same rights that apply to the Contractor under the Conditions of the Contract, including, without excluding others, those stated in Article 3, this Article 6 and Articles 10, 11 and 12.

### § 6.2 MUTUAL RESPONSIBILITY

§ 6.2.1 The Contractor shall afford the Owner and separate contractors reasonable opportunity for introduction and storage of their materials and equipment and performance of their activities, and shall connect and coordinate the Contractor's construction and operations with theirs as required by the Contract Documents.

§ 6.2.2 If part of the Contractor's Work depends for proper execution or results upon construction or operations by the Owner or a separate contractor, the Contractor shall, prior to proceeding with that portion of the Work, promptly report to the Architect apparent discrepancies or defects in such other construction that would render it unsuitable for such proper execution and results. Failure of the Contractor so to report shall constitute an acknowledgment that the Owner's or separate contractor's completed or partially completed construction is fit and proper to receive the Contractor's Work, except as to defects not then reasonably discoverable.

§ 6.2.3 The Contractor shall reimburse the Owner for costs the Owner incurs that are payable to a separate contractor because of the Contractor's delays, improperly timed activities or defective construction. The Owner shall be responsible to the Contractor for costs the Contractor incurs because of a separate contractor's delays, improperly timed activities, damage to the Work or defective construction.

§ 6.2.4 The Contractor shall promptly remedy damage the Contractor wrongfully causes to completed or partially completed construction or to property of the Owner or separate contractors as provided in Section 10.2.5.

§ 6.2.5 The Owner and each separate contractor shall have the same responsibilities for cutting and patching as are described for the Contractor in Section 3.14.

### § 6.3 OWNER'S RIGHT TO CLEAN UP

If a dispute arises among the Contractor, separate contractors and the Owner as to the responsibility under their respective contracts for maintaining the premises and surrounding area free from waste materials and rubbish, the Owner may clean up and the Architect will allocate the cost among those responsible.

## ARTICLE 7 CHANGES IN THE WORK

### § 7.1 GENERAL

§ 7.1.1 Changes in the Work may be accomplished after execution of the Contract, and without invalidating the Contract, by Change Order, Construction Change Directive or order for a minor change in the Work, subject to the limitations stated in this Article 7 and elsewhere in the Contract Documents. The total of all Change Orders on each contract shall not exceed ten percent (10%) of the contract price for each project and shall be subject to at least one of the following criteria:

- 1 Minor changes for a total monetary value less than required for competitive bidding under the State Competitive Bid Laws.
- 2 Changes for matters relatively minor and incidental to the original contract necessitated by unforeseen circumstances arising during the course of the Work.
- 3 Emergencies arising during the course of the Work on the Contract.
- 4 Changes or Alternates provided for in the original bidding where there is no difference in price on the Change Order from the original best bid on the Alternate.
- 5 Changes of relatively minor items not contemplated when the plans and specifications were prepared and the project was bid which are in the public interest.

§ 7.1.2 A Change Order shall be based upon agreement among the Owner, Contractor and Architect; a Construction Change Directive requires agreement by the Owner and Architect and may or may not be agreed to by the Contractor; an order for a minor change in the Work may be issued by the Architect alone.

§ 7.1.3 Changes in the Work shall be performed under applicable provisions of the Contract Documents, and the Contractor shall proceed promptly, unless otherwise provided in the Change Order, Construction Change Directive or order for a minor change in the Work.

### § 7.2 CHANGE ORDERS

§ 7.2.1 A Change Order is a written instrument prepared by the Architect and signed by the Owner, Contractor and Architect stating their agreement upon all of the following:

- 1 The change in the Work;
- 2 The amount of the adjustment, if any, in the Contract Sum; and
- 3 The extent of the adjustment, if any, in the Contract Time.
- 4 There shall be attached to each Change Order a signed statement from the Architect containing the following:
  - A. A statement of what the Change Order covers and who instituted the Change Order and why it is necessary or desired.
  - B. A statement setting forth the reasons for using the Change Order method rather than taking new competitive bids.
  - C. A statement that all prices have been reviewed and found reasonable, fair and equitable and recommending approval of the same.

### § 7.3 CONSTRUCTION CHANGE DIRECTIVES

§ 7.3.1 A Construction Change Directive is a written order prepared by the Architect and signed by the Owner and Architect, directing a change in the Work prior to agreement on adjustment, if any, in the Contract Sum or Contract Time, or both. The Owner may by Construction Change Directive, without invalidating the Contract, order changes

Init.

AIA Document A201™ - 2007. Copyright © 1911, 1915, 1918, 1925, 1937, 1951, 1958, 1961, 1963, 1966, 1970, 1976, 1987, 1997 and 2007 by The American Institute of Architects. All rights reserved. WARNING: This AIA® Document is protected by U.S. Copyright Law and International Treaties. Unauthorized reproduction or distribution of this AIA® Document, or any portion of it, may result in severe civil and criminal penalties, and will be prosecuted to the maximum extent possible under the law. This document was produced by AIA software at 15:13:02 on 07/19/2017 under Order No.7986168957\_1 which expires on 08/01/2017, and is not for resale.

User Notes:

(1383216234)

in the Work within the general scope of the Contract consisting of additions, deletions or other revisions, the Contract Sum and Contract Time being adjusted accordingly.

§ 7.3.2 A Construction Change Directive shall be used in the absence of total agreement on the terms of a Change Order.

§ 7.3.3 If the Construction Change Directive provides for an adjustment to the Contract Sum, the adjustment shall be based on one of the following methods:

- 1 Mutual acceptance of a lump sum properly itemized and supported by sufficient substantiating data to permit evaluation;
- 2 Unit prices stated in the Contract Documents or subsequently agreed upon;
- 3 Cost to be determined in a manner agreed upon by the parties and a mutually acceptable fixed or percentage fee; or
- 4 As provided in Section 7.3.7.

§ 7.3.4 If unit prices are stated in the Contract Documents or subsequently agreed upon, and if quantities originally contemplated are materially changed in a proposed Change Order or Construction Change Directive so that application of such unit prices to quantities of Work proposed will cause substantial inequity to the Owner or Contractor, the applicable unit prices ~~shall~~ may be equitably adjusted.

§ 7.3.5 Upon receipt of a Construction Change Directive, the Contractor shall promptly proceed with the change in the Work involved and advise the Architect of the Contractor's agreement or disagreement with the method, if any, provided in the Construction Change Directive for determining the proposed adjustment in the Contract Sum or Contract Time.

§ 7.3.6 A Construction Change Directive signed by the Contractor indicates the Contractor's agreement therewith, including adjustment in Contract Sum and Contract Time or the method for determining them. Such agreement shall be effective immediately and shall be recorded as a Change Order.

§ 7.3.7 If the Contractor does not respond promptly or disagrees with the method for adjustment in the Contract Sum, the Architect shall determine the method and the adjustment on the basis of reasonable expenditures and savings of those performing the Work attributable to the change, including, in case of an increase in the Contract Sum, an amount for overhead and profit as set forth in the Agreement, or if no such amount is set forth in the Agreement, a reasonable amount, allowance of 10% mark-up on Subcontractor's direct cost (actual cost of Labor & Materials) and 15% mark-up on a Contractor's direct (actual cost of Labor & Materials). In such case, and also under Section 7.3.3.3, the Contractor shall keep and present, in such form as the Architect may prescribe, an itemized accounting together with appropriate supporting data. Unless otherwise provided in the Contract Documents, costs for the purposes of this Section 7.3.7 shall be limited to the following:

- 1 Costs of labor, including social security, old age and unemployment insurance, fringe benefits required by agreement or custom, and workers' compensation insurance;
- 2 Costs of materials, supplies and equipment, including cost of transportation, ~~whether incorporated or consumed; actually incorporated or consumed in the work;~~
- 3 Rental costs of machinery and equipment, exclusive of hand tools, whether rented ~~from~~ by the Contractor or others;
- 4 Costs of premiums for all bonds and insurance, permit fees, and sales, use or similar taxes related to the Work; and
- 5 Additional costs of supervision and field office personnel directly attributable to the change.

§ 7.3.8 The amount of credit to be allowed by the Contractor to the Owner for a deletion or change that results in a net decrease in the Contract Sum shall be actual net cost as confirmed by the Architect. When both additions and credits covering related Work or substitutions are involved in a change, the allowance for overhead and profit shall be figured on the basis of net increase, if any, with respect to that change.

§ 7.3.9 Pending final determination of the total cost of a Construction Change Directive to the Owner, the Contractor may request payment for Work completed under the Construction Change Directive in Applications for Payment. The Architect will make an interim determination for purposes of monthly certification for payment for those costs and certify for payment the amount that the Architect determines, in the Architect's professional judgment, to be

Init.

AIA Document A201™ - 2007. Copyright © 1911, 1915, 1918, 1925, 1937, 1951, 1958, 1961, 1963, 1966, 1970, 1976, 1987, 1997 and 2007 by The American Institute of Architects. All rights reserved. WARNING: This AIA® Document is protected by U.S. Copyright Law and International Treaties. Unauthorized reproduction or distribution of this AIA® Document, or any portion of it, may result in severe civil and criminal penalties, and will be prosecuted to the maximum extent possible under the law. This document was produced by AIA software at 15:13:02 on 07/19/2017 under Order No.7986168957\_1 which expires on 08/01/2017, and is not for resale.

User Notes:

(1383216234)



reasonably justified. The Architect's interim determination of cost shall adjust the Contract Sum on the same basis as a Change Order, subject to the right of either party to disagree and assert a Claim in accordance with Article 15.

§ 7.3.10 When the Owner and Contractor agree with a determination made by the Architect concerning the adjustments in the Contract Sum and Contract Time, or otherwise reach agreement upon the adjustments, such agreement shall be effective immediately and the Architect will prepare a Change Order. Change Orders may be issued for all or any part of a Construction Change Directive.

#### § 7.4 MINOR CHANGES IN THE WORK

The Architect has authority to order minor changes in the Work not involving adjustment in the Contract Sum or extension of the Contract Time and not inconsistent with the intent of the Contract Documents. Such changes will be effected by written order signed by the Architect and shall be binding on the Owner and Contractor.

### ARTICLE 8 TIME

#### § 8.1 DEFINITIONS

§ 8.1.1 Unless otherwise provided, Contract Time is the period of time, including authorized adjustments, allotted in the Contract Documents for Substantial Completion of the Work.

§ 8.1.2 The date of commencement of the Work is the date established in the Agreement.

§ 8.1.3 The date of Substantial Completion is the date certified by the Architect in accordance with Section 9.8.

§ 8.1.4 The term "day" as used in the Contract Documents shall mean calendar day unless otherwise specifically defined.

#### § 8.2 PROGRESS AND COMPLETION

§ 8.2.1 Time limits stated in the Contract Documents are of the essence of the Contract. By executing the Agreement the Contractor confirms that the Contract Time is a reasonable period for performing the Work.

§ 8.2.2 The Contractor shall not knowingly, except by agreement or instruction of the Owner in writing, prematurely commence operations on the site or elsewhere prior to the effective date of insurance required by Article 11 to be furnished by the Contractor and Owner. The date of commencement of the Work shall not be changed by the effective date of such insurance.

1. No Work shall commence and no materials ordered until the Owner issues the written Notice to Proceed.
2. The Work shall be commenced within ten (10) days of the date of a written Notice to Proceed.

§ 8.2.3 The Contractor shall proceed expeditiously with adequate forces and shall achieve Substantial Completion within the Contract Time.

#### § 8.3 DELAYS AND EXTENSIONS OF TIME

§ 8.3.1 If the Contractor is delayed at any time in the commencement or progress of the Work by an act or neglect of the Owner or Architect, or of an employee of either, or of a separate contractor employed by the Owner; or by changes ordered in the Work; or by labor disputes, fire, unusual delay in deliveries, unavoidable casualties or other causes beyond the Contractor's control; or by delay authorized by the Owner pending mediation and arbitration; Owner; or by other causes that the Architect determines may justify delay, then the Contract Time shall be extended by Change Order for such reasonable time as the Architect may determine.

§ 8.3.2 Claims relating to time shall be made in accordance with applicable provisions of Article 15.

§ 8.3.3 This Section 8.3 does not preclude recovery of damages for delay by either party under other provisions of the Contract Documents.

#### § 8.4 LIQUIDATED DAMAGES

8.4.1 Time is the essence of the Contract. Any delay in the completion of the Work as provided for in the Contract Documents will cause inconvenience to the public and loss and damage to the Owner in interest, and in additional administrative, architectural, inspection, and supervision charges.



Therefore, a time charge equal to \$250.00 per calendar day will be made against the Contractor for the entire period that any part of the Work remains uncompleted or any required closeouts documents are not acceptably submitted for more than 30 days after the time specified for the Substantial Completion of the Work, the amount of which shall be deducted by the Owner, and shall be retained by the Owner out of monies otherwise due the Contractor in the final payment, not as a penalty, but as liquidated damages sustained.

## ARTICLE 9 PAYMENTS AND COMPLETION

### § 9.1 CONTRACT SUM

The Contract Sum is stated in the Agreement and, including authorized adjustments, is the total amount payable by the Owner to the Contractor for performance of the Work under the Contract Documents.

### § 9.2 SCHEDULE OF VALUES

Where the Contract is based on a stipulated sum or Guaranteed Maximum Price, the Contractor shall submit to the Architect, before the first Application for Payment, a schedule of values allocating the entire Contract Sum to the various portions of the Work and prepared in such form and supported by such data to substantiate its accuracy as the Architect may require. This schedule, unless objected to by the Architect, shall be used as a basis for reviewing the Contractor's Applications for Payment.

.1 Unit Prices and Allowances, if stated in the Contract Documents, shall be identified within the Schedule of Values.

### § 9.3 APPLICATIONS FOR PAYMENT

~~§ 9.3.1 At least ten days before the date established for each progress payment, the~~ The Contractor shall submit to the Architect an itemized Application for Payment prepared in accordance with the on the first of each month; for Work done through the 25<sup>th</sup> of the preceding month, four (4) original, itemized Applications for Payment for Work completed in accordance with the accepted schedule of values, if required under Section 9.2, 9.2., for completed portions of the Work. Such application shall be notarized, if required, notarized and supported by such data substantiating the Contractor's right to payment as the Owner or Architect may require, such as copies of requisitions from Subcontractors subcontractors and material suppliers, and shall reflect retainage if provided for in the Contract Documents and documents as follows:

.1 Until the final payment is made, the Owner shall pay ninety-seven and one half percent (97.5%) of the amount due the Contractor on account of progress payments (note: the 2-1/2% retainage is calculated by withholding the first 5% of the first 50% of the work completed); and

.2 The Contractor shall provide documentation substantiating that test, inspections and approvals for portions of Work included in an Application for Payment and required by the Contract Documents, or by laws, ordinances, rules, regulations or orders of public authorities having jurisdiction were made at the appropriate time.

~~§ 9.3.1.1 As provided in Section 7.3.9, such~~ Such applications may include requests for payment on account of changes in the Work that have been properly authorized by Construction Change Directives, or by interim determinations of the Architect, but not yet included in Change Orders. Work, which have been authorized and approved by properly executed Change Order(s).

~~§ 9.3.1.2 Applications for Payment shall not include requests for payment for portions of the Work for which the Contractor does not intend to pay a Subcontractor or material supplier, unless such Work has been performed by others whom the Contractor intends to pay. Such applications may include requests for payment on account of changes in the Work, which have been authorized and approve by properly executed Change Order(s).~~

§ 9.3.2 Unless otherwise provided in the Contract Documents, payments shall be made on account of materials and equipment delivered and suitably stored at the site for subsequent incorporation in the Work. If approved in advance by the Owner, payment may similarly be made for materials and equipment suitably stored off the site at a location agreed upon in writing. Payment for materials and equipment stored on or off the site shall be conditioned upon compliance by the Contractor with procedures satisfactory to the Owner to establish the Owner's title to such materials and equipment or otherwise protect the Owner's interest, and shall include the costs of applicable insurance, storage and transportation to the site for such materials and equipment stored off the site.

§ 9.3.3 The Contractor warrants that title to all Work covered by an Application for Payment will pass to the Owner no later than the time of payment. The Contractor further warrants that upon submittal of an Application for Payment all Work for which Certificates for Payment have been previously issued and payments received from the Owner shall, to the best of the Contractor's knowledge, information and belief, be free and clear of liens, claims, security interests or encumbrances in favor of the Contractor, Subcontractors, material suppliers, or other persons or entities making a claim by reason of having provided labor, materials and equipment relating to the Work.

#### § 9.4 CERTIFICATES FOR PAYMENT

§ 9.4.1 The Architect will, within seven days after receipt of the Contractor's Application for Payment, either issue to the Owner a Certificate for Payment, with a copy to the Contractor, for such amount as the Architect determines is properly due, or notify the Contractor and Owner in writing of the Architect's reasons for withholding certification in whole or in part as provided in Section 9.5.1.

§ 9.4.2 The issuance of a Certificate for Payment will constitute a representation by the Architect to the Owner, based on the Architect's evaluation of the Work and the data comprising the Application for Payment, that, to the best of the Architect's knowledge, information and belief, the Work has progressed to the point indicated and that the quality of the Work is in accordance with the Contract Documents. The foregoing representations are subject to an evaluation of the Work for conformance with the Contract Documents upon Substantial Completion, to results of subsequent tests and inspections, to correction of minor deviations from the Contract Documents prior to completion and to specific qualifications expressed by the Architect. The issuance of a Certificate for Payment will further constitute a representation that the Contractor is entitled to payment in the amount certified. However, the issuance of a Certificate for Payment will not be a representation that the Architect has (1) made exhaustive or continuous on-site inspections to check the quality or quantity of the Work, (2) reviewed construction means, methods, techniques, sequences or procedures, (3) reviewed copies of requisitions received from Subcontractors and material suppliers and other data requested by the Owner to substantiate the Contractor's right to payment, or (4) made examination to ascertain how or for what purpose the Contractor has used money previously paid on account of the Contract Sum.

#### § 9.5 DECISIONS TO WITHHOLD CERTIFICATION

§ 9.5.1 The Architect may withhold a Certificate for Payment in whole or in part, to the extent reasonably necessary to protect the Owner, if in the Architect's opinion the representations to the Owner required by Section 9.4.2 cannot be made. If the Architect is unable to certify payment in the amount of the Application, the Architect will notify the Contractor and Owner as provided in Section 9.4.1. If the Contractor and Architect cannot agree on a revised amount, the Architect will promptly issue a Certificate for Payment for the amount for which the Architect is able to make such representations to the Owner. The Architect may also withhold a Certificate for Payment or, because of subsequently discovered evidence, may nullify the whole or a part of a Certificate for Payment previously issued, to such extent as may be necessary in the Architect's opinion to protect the Owner from loss for which the Contractor is responsible, including loss resulting from acts and omissions described in Section 3.3.2, because of

- .1 defective Work not remedied;
- .2 third party claims filed or reasonable evidence indicating probable filing of such claims unless security acceptable to the Owner is provided by the Contractor;
- .3 failure of the Contractor to make payments properly to Subcontractors or for labor, materials or equipment;
- .4 reasonable evidence that the Work cannot be completed for the unpaid balance of the Contract Sum;
- .5 damage to the Owner or a separate contractor;
- .6 reasonable evidence that the Work will not be completed within the Contract Time, and that the unpaid balance would not be adequate to cover actual or liquidated damages for the anticipated delay; or
- .7 repeated failure to carry out the Work in accordance with the Contract Documents.

§ 9.5.2 When the above reasons for withholding certification are removed, certification will be made for amounts previously withheld.

§ 9.5.3 If the Architect withholds certification for payment under Section 9.5.1.3, the Owner may, at its sole option, issue joint checks to the Contractor and to any Subcontractor or material or equipment suppliers to whom the Contractor failed to make payment for Work properly performed or material or equipment suitably delivered. If the

Init.

AIA Document A201™ – 2007. Copyright © 1911, 1915, 1918, 1925, 1937, 1951, 1958, 1961, 1963, 1966, 1970, 1976, 1987, 1997 and 2007 by The American Institute of Architects. All rights reserved. WARNING: This AIA® Document is protected by U.S. Copyright Law and International Treaties. Unauthorized reproduction or distribution of this AIA® Document, or any portion of it, may result in severe civil and criminal penalties, and will be prosecuted to the maximum extent possible under the law. This document was produced by AIA software at 15:13:02 on 07/19/2017 under Order No.7986168957\_1 which expires on 08/01/2017, and is not for resale.

User Notes:

(1383216234)

Owner makes payments by joint check, the Owner shall notify the Architect and the Architect will reflect such payment on the next Certificate for Payment.

#### § 9.6 PROGRESS PAYMENTS

§ 9.6.1 After the Architect has issued a Certificate for Payment, the Owner shall make payment in the manner and within the time provided in the Contract Documents, and shall so notify the Architect.

§ 9.6.2 The Contractor shall pay each Subcontractor no later than seven days after receipt of payment from the Owner the amount to which the Subcontractor is entitled, reflecting percentages actually retained from payments to the Contractor on account of the Subcontractor's portion of the Work. The Contractor shall, by appropriate agreement with each Subcontractor, require each Subcontractor to make payments to Sub-subcontractors in a similar manner.

§ 9.6.3 The Architect will, on request, furnish to a Subcontractor, if practicable, information regarding percentages of completion or amounts applied for by the Contractor and action taken thereon by the Architect and Owner on account of portions of the Work done by such Subcontractor.

§ 9.6.4 The Owner has the right to request written evidence from the Contractor that the Contractor has properly paid Subcontractors and material and equipment suppliers amounts paid by the Owner to the Contractor for subcontracted Work. If the Contractor fails to furnish such evidence within seven days, the Owner shall have the right to contact Subcontractors to ascertain whether they have been properly paid. Neither the Owner nor Architect shall have an obligation to pay or to see to the payment of money to a Subcontractor, except as may otherwise be required by law.

§ 9.6.5 Contractor payments to material and equipment suppliers shall be treated in a manner similar to that provided in Sections 9.6.2, 9.6.3 and 9.6.4.

§ 9.6.6 A Certificate for Payment, a progress payment, or partial or entire use or occupancy of the Project by the Owner shall not constitute acceptance of Work not in accordance with the Contract Documents.

§ 9.6.7 Unless the Contractor provides the Owner with a payment bond in the full penal sum of the Contract Sum, payments received by the Contractor for Work properly performed by Subcontractors and suppliers shall be held by the Contractor for those Subcontractors or suppliers who performed Work or furnished materials, or both, under contract with the Contractor for which payment was made by the Owner. Nothing contained herein shall require money to be placed in a separate account and not commingled with money of the Contractor, shall create any fiduciary liability or tort liability on the part of the Contractor for breach of trust or shall entitle any person or entity to an award of punitive damages against the Contractor for breach of the requirements of this provision.

#### § 9.7 FAILURE OF PAYMENT

If the Architect does not issue a Certificate for Payment, through no fault of the Contractor, within seven days after receipt of the Contractor's Application for Payment, or if the Owner does not pay the Contractor within seven days after the date established in the Contract Documents the amount certified by the Architect or awarded by binding dispute resolution, ~~Architect~~, then the Contractor may, upon seven additional days' written notice to the Owner and Architect, stop the Work until payment of the amount owing has been received. The Contract Time shall ~~may~~ be extended appropriately and the Contract Sum shall ~~may~~ be increased by the amount of the Contractor's reasonable costs of shut-down, delay and start-up, plus interest as provided for in the Contract Documents.

#### § 9.8 SUBSTANTIAL COMPLETION

§ 9.8.1 Substantial Completion is the stage in the progress of the Work when the Work or designated portion thereof is sufficiently complete in accordance with the Contract Documents so that the Owner can occupy or utilize the Work for its intended use.

§ 9.8.2 When the Contractor considers that the Work, or a portion thereof which the Owner agrees to accept separately, is substantially complete, the Contractor shall prepare and submit to the Architect a comprehensive list of items to be completed or corrected prior to final payment. Failure to include an item on such list does not alter the responsibility of the Contractor to complete all Work in accordance with the Contract Documents.

§ 9.8.3 Upon receipt of the Contractor's list, the Architect will make an inspection to determine whether the Work or designated portion thereof is substantially complete. If the Architect's inspection discloses any item, whether or not included on the Contractor's list, which is not sufficiently complete in accordance with the Contract Documents so that the Owner can occupy or utilize the Work or designated portion thereof for its intended use, the Contractor shall, before issuance of the Certificate of Substantial Completion, complete or correct such item upon notification by the Architect. In such case, the Contractor shall then submit a request for another inspection by the Architect to determine Substantial Completion.

§ 9.8.4 When the Work or designated portion thereof is substantially complete, the Architect will prepare a Certificate of Substantial Completion that shall establish the date of Substantial Completion, shall establish responsibilities of the Owner and Contractor for security, maintenance, heat, utilities, damage to the Work and insurance, and shall fix the time within which the Contractor shall finish all items on the list accompanying the Certificate. Warranties required by the Contract Documents shall commence on the date of Substantial Completion of the Work or designated portion thereof unless otherwise provided in the Certificate of Substantial Completion.

§ 9.8.5 The Certificate of Substantial Completion shall be submitted to the Owner and Contractor for their written acceptance of responsibilities assigned to them in such Certificate. Upon such acceptance and consent of surety, if any, the Owner shall make payment of retainage applying to such Work or designated portion thereof. Such payment shall be adjusted for Work that is incomplete or not in accordance with the requirements of the Contract Documents. Work.

#### § 9.9 PARTIAL OCCUPANCY OR USE

§ 9.9.1 The Owner may occupy or use any completed or partially completed portion of the Work at any stage when such portion is designated by separate agreement with the Contractor, provided such occupancy or use is consented to by the insurer as required under Section 11.3.1.5 and authorized by public authorities having jurisdiction over the Project. Such partial occupancy or use may commence whether or not the portion is substantially complete, provided the Owner and Contractor have accepted in writing the responsibilities assigned to each of them for payments, retainage, if any, security, maintenance, heat, utilities, damage to the Work and insurance, and have agreed in writing concerning the period for correction of the Work and commencement of warranties required by the Contract Documents. When the Contractor considers a portion substantially complete, the Contractor shall prepare and submit a list to the Architect as provided under Section 9.8.2. Consent of the Contractor to partial occupancy or use shall not be unreasonably withheld. The stage of the progress of the Work shall be determined by written agreement between the Owner and Contractor or, if no agreement is reached, by decision of the Architect.

§ 9.9.2 Immediately prior to such partial occupancy or use, the Owner, Contractor and Architect shall jointly inspect the area to be occupied or portion of the Work to be used in order to determine and record the condition of the Work.

§ 9.9.3 Unless otherwise agreed upon, partial occupancy or use of a portion or portions of the Work shall not constitute acceptance of Work not complying with the requirements of the Contract Documents.

#### § 9.10 FINAL COMPLETION AND FINAL PAYMENT

§ 9.10.1 Upon receipt of the Contractor's written notice that the Work is ready for final inspection and acceptance and upon receipt of a final Application for Payment, the Architect will promptly make such inspection and, when the Architect finds the Work acceptable under the Contract Documents and the Contract fully performed, the Architect will promptly issue a final Certificate for Payment stating that to the best of the Architect's knowledge, information and belief, and on the basis of the Architect's on-site visits and inspections, the Work has been completed in accordance with terms and conditions of the Contract Documents and that the entire balance found to be due the Contractor and noted in the final Certificate is due and payable. The Architect's final Certificate for Payment will constitute a further representation that conditions listed in Section 9.10.2 as precedent to the Contractor's being entitled to final payment have been fulfilled.

§ 9.10.2 Neither final payment nor any remaining retained percentage shall become due until the Contractor submits to the Architect (1) an affidavit that payrolls, bills for materials and equipment, and other indebtedness connected with the Work for which the Owner or the Owner's property might be responsible or encumbered (less amounts withheld by Owner) have been paid or otherwise satisfied, (2) a certificate evidencing that insurance required by the Contract Documents to remain in force after final payment is currently in effect and will not be canceled or allowed

to expire until at least 30 days' prior written notice has been given to the Owner, (3) a written statement that the Contractor knows of no substantial reason that the insurance will not be renewable to cover the period required by the Contract Documents, (4) consent of surety, if any, to final payment and (5), if required by the Owner, other data establishing payment or satisfaction of obligations, such as receipts, releases and waivers of liens, claims, security interests or encumbrances arising out of the Contract, to the extent and in such form as may be designated by the Owner. If a Subcontractor refuses to furnish a release or waiver required by the Owner, the Contractor may furnish a bond satisfactory to the Owner to indemnify the Owner against such lien. If such lien remains unsatisfied after payments are made, the Contractor shall refund to the Owner all money that the Owner may be compelled to pay in discharging such lien, including all costs and reasonable attorneys' fees payment. (5), contractors Affidavit of Release of Liens, (6) separate Releases or Waivers of Liens from Subcontractors and material and equipment suppliers (7) written warranty on Contractor's letterhead covering materials and labor for one year, and (8) the advertisement of completion. The Contractor shall provide proof of publication of Advertisement of completion in a local newspaper for four (4) consecutive weeks, as required in Title 39, Section 39-1-1, Subsection (f), of the Code of Alabama. The final 2.5% retained will not be paid until proof of publication is submitted and all written claims paid in full. This advertisement shall not begin until the City of Mobile has accepted the Project.

§ 9.10.3 If, after Substantial Completion of the Work, final completion thereof is materially delayed through no fault of the Contractor or by issuance of Change Orders affecting final completion, Contractor, and the Architect so confirms, the Owner shall, upon application by the Contractor and certification by the Architect, and without terminating the Contract, make payment of the balance due for that portion of the Work fully completed and accepted. If the remaining balance for Work not fully completed or corrected is less than retainage stipulated in the Contract Documents, and if bonds have been furnished, the written consent of surety to payment of the balance due for that portion of the Work fully completed and accepted shall be submitted by the Contractor to the Architect prior to certification of such payment. Such payment shall be made under terms and conditions governing final payment, except that it shall not constitute a waiver of claims.

§ 9.10.4 The making of final payment shall constitute a waiver of Claims by the Owner except those arising from

1. Liens, Claims, security interests or encumbrances arising out of the Contract and unsettled;
2. failure of the Work to comply with the requirements of the Contract Documents; or
3. terms of special warranties required by the Contract Documents.

§ 9.10.5 Acceptance of final payment by the Contractor, a Subcontractor or material supplier shall constitute a waiver of claims by that payee except those previously made in writing and identified by that payee as unsettled at the time of final Application for Payment.

## ARTICLE 10 PROTECTION OF PERSONS AND PROPERTY

### § 10.1 SAFETY PRECAUTIONS AND PROGRAMS

The Contractor shall be responsible for initiating, maintaining and supervising all safety precautions and programs in connection with the performance of the Contract.

### § 10.2 SAFETY OF PERSONS AND PROPERTY

§ 10.2.1 The Contractor shall comply with all Federal, State and Local law regarding safety including the requirements of the Occupational Safety and Health Act of 1970, Public Law #91-596, latest revision. Contractor shall take all other reasonable precautions for safety of, and shall provide reasonable protection to prevent damage, injury or loss to

1. employees on the Work and other persons who may be affected thereby;
2. the Work and materials and equipment to be incorporated therein, whether in storage on or off the site, under care, custody or control of the Contractor or the Contractor's Subcontractors or Sub-subcontractors; and
3. other property at the site or adjacent thereto, such as trees, shrubs, lawns, walks, pavements, roadways, structures and utilities not designated for removal, relocation or replacement in the course of construction.
4. The Contractor shall be responsible for damage done to buried cables and other utilities by its equipment and shall contact the appropriate offices prior to construction for information depth, etc., of utilities in the area.

Init.

§ 10.2.2 The Contractor shall comply with and give notices required by applicable laws, statutes, ordinances, codes, rules and regulations, and lawful orders of public authorities bearing on safety of persons or property or their protection from damage, injury or loss.

§ 10.2.3 The Contractor shall erect and maintain, as required by existing conditions and performance of the Contract, reasonable safeguards for safety and protection, including posting danger signs and other warnings against hazards, promulgating safety regulations and notifying owners and users of adjacent sites and utilities.

§ 10.2.4 When use or storage of explosives or other hazardous materials or equipment or unusual methods are necessary for execution of the Work, the Contractor shall exercise utmost care and carry on such activities under supervision of properly qualified personnel.

§ 10.2.5 The Contractor shall promptly remedy damage and loss ~~(other than damage or loss insured under property insurance required by the Contract Documents)~~ loss to property referred to in Sections 10.2.1.2 and 10.2.1.3 caused in whole or in part by the Contractor, a Subcontractor, a Sub-subcontractor, or anyone directly or indirectly employed by any of them, or by anyone for whose acts they may be liable and for which the Contractor is responsible under Sections 10.2.1.2 and 10.2.1.3, except damage or loss attributable to acts or omissions of the Owner or Architect or anyone directly or indirectly employed by either of them, or by anyone for whose acts either of them may be liable, and not attributable to the fault or negligence of the Contractor. The foregoing obligations of the Contractor are in addition to the Contractor's obligations under Section 3.18.

§ 10.2.6 The Contractor shall designate a responsible member of the Contractor's organization at the site whose duty shall be the prevention of accidents. This person shall be the Contractor's superintendent unless otherwise designated by the Contractor in writing to the Owner and Architect.

§ 10.2.7 The Contractor shall not permit any part of the construction or site to be loaded so as to cause damage or create an unsafe condition.

#### § 10.2.8 INJURY OR DAMAGE TO PERSON OR PROPERTY

If either party suffers injury or damage to person or property because of an act or omission of the other party, or of others for whose acts such party is legally responsible, written notice of such injury or damage, whether or not insured, shall be given to the other party within a reasonable time not exceeding 21 days after discovery. The notice shall provide sufficient detail to enable the other party to investigate the matter.

#### § 10.3 HAZARDOUS MATERIALS

§ 10.3.1 The Contractor is responsible for compliance with any requirements included in the Contract Documents regarding hazardous materials. If the Contractor encounters a hazardous material or substance not addressed in the Contract Documents and if reasonable precautions will be inadequate to prevent foreseeable bodily injury or death to persons resulting from a material or substance, including but not limited to asbestos or polychlorinated biphenyl (PCB), encountered on the site by the Contractor, the Contractor shall, upon recognizing the condition, immediately stop Work in the affected area and report the condition to the Owner and Architect in writing.

§ 10.3.2 Upon receipt of the Contractor's written notice, the Owner shall obtain the services of a licensed laboratory to verify the presence or absence of the material or substance reported by the Contractor and, in the event such material or substance is found to be present, to cause it to be rendered harmless. Unless otherwise required by the Contract Documents, the Owner shall furnish in writing to the Contractor and Architect the names and qualifications of persons or entities who are to perform tests verifying the presence or absence of such material or substance or who are to perform the task of removal or safe containment of such material or substance. The Contractor and the Architect will promptly reply to the Owner in writing stating whether or not either has reasonable objection to the persons or entities proposed by the Owner. If either the Contractor or Architect has an objection to a person or entity proposed by the Owner, the Owner shall propose another to whom the Contractor and the Architect have no reasonable objection. When the material or substance has been rendered harmless, Work in the affected area shall resume upon written agreement of the Owner and Contractor. By Change Order, the Contract Time shall be extended appropriately and the Contract Sum shall be increased in the amount of the Contractor's reasonable additional costs of shut-down, delay and ~~start-up~~ except to the extent that any such delay is attributable to the Contractor's objection to the persons or entities whom Owner shall have furnished to perform the task of removal or safe containment of such material or substance.

~~§ 10.3.3 To the fullest extent permitted by law, the Owner shall indemnify and hold harmless the Contractor, Subcontractors, Architect, Architect's consultants and agents and employees of any of them from and against claims, damages, losses and expenses, including but not limited to attorneys' fees, arising out of or resulting from performance of the Work in the affected area if in fact the material or substance presents the risk of bodily injury or death as described in Section 10.3.1 and has not been rendered harmless, provided that such claim, damage, loss or expense is attributable to bodily injury, sickness, disease or death, or to injury to or destruction of tangible property (other than the Work itself), except to the extent that such damage, loss or expense is due to the fault or negligence of the party seeking indemnity.~~

~~§ 10.3.4 The Owner shall not be responsible under this Section 10.3 for materials or substances the Contractor brings to the site unless such materials or substances are required by the Contract Documents. The Owner shall be responsible for materials or substances required by the Contract Documents, except to the extent of the Contractor's fault or negligence in the use and handling of such materials or substances for materials or substances brought to the site by the Contractor regardless of whether such materials or substances were required by the Contract Documents.~~

§ 10.3.5 The Contractor shall indemnify the Owner for the cost and expense the Owner incurs (1) for remediation of a material or substance the Contractor brings to the site and negligently handles, or (2) where the Contractor fails to perform its obligations under Section 10.3.1, except to the extent that the cost and expense are due to the Owner's fault or negligence.

§ 10.3.6 If, without negligence or wantonness on the part of the Contractor, the Contractor is held liable by a government agency for the cost of remediation of a hazardous material or substance solely by reason of performing Work as required by the Contract Documents, the Owner shall indemnify ~~may reimburse~~ the Contractor for all reasonable cost and expense thereby incurred.

#### § 10.4 EMERGENCIES

In an emergency affecting safety of persons or property, the Contractor shall act, at the Contractor's discretion, to prevent threatened damage, injury or loss. Additional compensation or extension of time claimed by the Contractor on account of an emergency shall ~~may~~ be determined only as provided in Article 15 and Article 7.

### ARTICLE 11 INSURANCE AND BONDS

#### § 11.1 CONTRACTOR'S LIABILITY INSURANCE

§ 11.1.1 The Contractor shall purchase from and maintain in a company or companies lawfully authorized to do business in the jurisdiction in which the Project is located such insurance as will protect the Contractor from claims set forth below which may arise out of or result from the Contractor's operations and completed operations under the Contract and for which the Contractor may be legally liable, whether such operations be by the Contractor or by a Subcontractor or by anyone directly or indirectly employed by any of them, or by anyone for whose acts any of them may be liable:

- .1 Claims under workers' compensation, disability benefit and other similar employee benefit acts that are applicable to the Work to be performed;
- .2 Claims for damages because of bodily injury, occupational sickness or disease, or death of the Contractor's employees;
- .3 Claims for damages because of bodily injury, sickness or disease, or death of any person other than the Contractor's employees;
- .4 Claims for damages insured by usual personal injury liability coverage;
- .5 Claims for damages, ~~other than to the Work itself,~~ because of injury to or destruction of tangible property, including loss of use resulting therefrom;
- .6 Claims for damages because of bodily injury, death of a person or property damage arising out of ownership, maintenance or use of a motor vehicle;
- .7 Claims for bodily injury or property damage arising out of completed operations; and
- .8 Claims involving contractual liability insurance applicable to the Contractor's obligations under Section 3.18.

The Contractor shall take out and maintain during the life of the Contract no less than the following amounts of insurance with the Owner named as an additional insured. Contractor shall submit a Certificate of Insurance and a supplemental Attachment for Certificate of Insurance 25-2 (7/90), AIA Document G715, Insurance companies listed as the "Companies Affording Coverage"

Init.

AIA Document A201™ – 2007. Copyright © 1911, 1915, 1918, 1925, 1937, 1951, 1958, 1961, 1963, 1966, 1970, 1976, 1987, 1997 and 2007 by The American Institute of Architects. All rights reserved. WARNING: This AIA® Document is protected by U.S. Copyright Law and International Treaties. Unauthorized reproduction or distribution of this AIA® Document, or any portion of it, may result in severe civil and criminal penalties, and will be prosecuted to the maximum extent possible under the law. This document was produced by AIA software at 15:13:02 on 07/19/2017 under Order No.7986168957\_1 which expires on 08/01/2017, and is not for resale.

User Notes:

(1383216234)



shall be authorized by the Secretary of the State of Alabama. Insurance produced out of the State of Alabama must be signed or counter signed by a Resident Agent of Alabama, with the Resident Agent's name, address and telephone number typed or printed on the face of the Certificate of Insurance.

1 Workmen's Compensation and Employer's Liability Insurance: - Statutory-amount and coverage as required by law of place in which the Work is performed.

2 Employee's Liability Insurance shall be provided for limits of liability not less than:

A. Bodily Injury by Accident \$1,000,000 each accident

B. Bodily Injury by Disease \$1,000,000 each employee

3 The Contractor shall provide Broad Form (commonly termed Comprehensive) General Liability Insurance (including premises-product-completed operations) for limits of liability not less than:

A. Bodily Injury \$1,000,000 each person

\$1,000,000 each occurrence

B. Property Damage \$1,000,000 each occurrence; or

C. Bodily Injury & Property Damage \$1,000,000 combined single limit

4 Such comprehensive policy shall include the following:

A. All liability of the Contractor, for the Contractor's Direct Operations.

B. Subcontractor's Operations.

C. Completed Operations Cover, thereby meaning any loss which shall occur after the contract has been completed, but which can be traced back to the Contract.

D. Contractual Liability, meaning thereby; any risk assumed by the Contractor under Hold Harmless Agreements or any other assumption of liability, but specifically Items 11.1.1.8.3G herein below

E. Broad Form Property damage Coverage, including Completed Operations.

F. Personal Injury Liability, with employee's exclusions removed.

G. The Contractor shall indemnify and save harmless the Owner against all loss, cost, or damaged on account of injuries to persons or property occurring in the performance of the Contract, including all reasonable attorney's fees incurred by the Owner, on account thereof.

H. Explosion and Collapse Hazard:  
Included or  Not Applicable.

I. Underground Hazard:  
Included or  Not Applicable.

5 The Contractor shall carry for himself and shall require that all Subcontractors and all Owners of Automobiles or trucks rented or hired on the contract carry until the Contract is completed. Comprehensive Automobile Liability Coverage for Bodily Injury and property Damage in amounts not less than the minimum amounts as indicated. The Contractor and Subcontractor shall also carry for themselves insurance for all non-owned and hired automobile at the limits of liability as indicated below:

A. Bodily Injury \$1,000,000 each person  
\$1,000,000 each occurrence

B. Property damage \$1,000,000 each occurrence; or

C. Bodily Injury & Property damage \$1,000,000 combined single limit

6. Excess Liability: \$2,000,000 limit

Init.

AIA Document A201™ - 2007. Copyright © 1911, 1915, 1918, 1925, 1937, 1951, 1958, 1961, 1963, 1966, 1970, 1976, 1987, 1997 and 2007 by The American Institute of Architects. All rights reserved. WARNING: This AIA® Document is protected by U.S. Copyright Law and International Treaties. Unauthorized reproduction or distribution of this AIA® Document, or any portion of it, may result in severe civil and criminal penalties, and will be prosecuted to the maximum extent possible under the law. This document was produced by AIA software at 15:13:02 on 07/19/2017 under Order No.7986168957\_1 which expires on 08/01/2017, and is not for resale.

User Notes:

(1383216234)



7. Builder's Risk Coverage. The Contractor shall carry for the Owner, himself, and all Subcontractor's a Builder's Risk Policy to cover the full amount of the Contract during construction, fabrications or erection of any equipment.

8. A Surety authorized to do business in the State of Alabama shall furnish the required insurance.

9. The ACCORD™ Certificate must be signed or countersigned by a Licensed Resident Agent of the State of Alabama and the agent's name, address and telephone number must appear on the face of the certificate.

10. The Surety must have a minimum rating of A/Class VI as reported in the latest issue of Best's Key Rating Guide Property-Casualty, published by Alfred M. Best Company, Inc., if the bid price exceeds \$50,000.00

§ 11.1.2 The insurance required by Section 11.1.1 shall be written for not less than limits of liability specified in the Contract Documents or required by law, whichever coverage is greater. Coverages, whether written on an occurrence or claims-made basis, shall be maintained without interruption from the date of commencement of the Work until the date of final payment and termination of any coverage required to be maintained after final payment, and, with respect to the Contractor's completed operations coverage, until the expiration of the period for correction of Work or for such other period for maintenance of completed operations coverage as specified in the Contract Documents.

§ 11.1.3 Certificates of insurance acceptable to the Owner shall be filed with the Owner prior to commencement of the Work and thereafter upon renewal or replacement of each required policy of insurance. These certificates and the insurance policies required by this Section 11.1 shall contain a provision that coverages afforded under the policies will not be canceled or allowed to expire until at least 30 days' prior written notice has been given to the Owner. An additional certificate evidencing continuation of liability coverage, including coverage for completed operations, shall be submitted with the final Application for Payment as required by Section 9.10.2 and thereafter upon renewal or replacement of such coverage until the expiration of the time required by Section 11.1.2. Information concerning reduction of coverage on account of revised limits or claims paid under the General Aggregate, or both, shall be furnished by the Contractor with reasonable promptness.

§ 11.1.4 The Contractor shall cause the commercial liability coverage required by the Contract Documents to include (1) the Owner, the Architect and the Architect's ~~consultants~~ Consultants as additional insureds for claims caused in whole or in part by the Contractor's negligent acts or omissions during the Contractor's operations; and (2) the Owner as an additional insured for claims caused in whole or in part by the Contractor's negligent acts or omissions during the Contractor's completed operations.

#### § 11.2 OWNER'S LIABILITY INSURANCE

The Owner shall be responsible for purchasing and maintaining the Owner's usual liability insurance.

#### § 11.3 PROPERTY INSURANCE

§ 11.3.1 ~~Unless otherwise provided, the Owner~~ The Contractor shall purchase and maintain, in a company or companies lawfully authorized to do business in the jurisdiction in which the Project is located, property insurance written on a builder's risk "all-risk" or equivalent policy form in the amount of the initial Contract Sum, plus value of subsequent Contract Modifications and cost of materials supplied or installed by others, comprising total value for the entire Project at the site on a replacement cost basis without optional ~~deductibles~~ deductibles (See 11.1.1 Supplement Builder's Risk Coverage). Such property insurance shall be maintained, unless otherwise provided in the Contract Documents or otherwise agreed in writing by all persons and entities who are beneficiaries of such insurance, until final payment has been made as provided in Section 9.10 or until no person or entity other than the Owner has an insurable interest in the property required by this Section 11.3 to be covered, whichever is later. This insurance shall include interests of the Owner, the Contractor, Subcontractors and Sub-subcontractors in the Project.

§ 11.3.1.1 Property insurance shall be on an "all-risk" or equivalent policy form and shall include, without limitation, insurance against the perils of fire (with extended coverage) and physical loss or damage including, without duplication of coverage, theft, vandalism, malicious mischief, collapse, earthquake, flood, windstorm, falsework, testing and startup, temporary buildings and debris removal including demolition occasioned by enforcement of any applicable legal requirements, and shall cover reasonable compensation for Architect's and Contractor's services and expenses required as a result of such insured loss.

§ 11.3.1.2 If the Owner does not intend to purchase such property insurance required by the Contract and with all of the coverages in the amount described above, the Owner shall so inform the Contractor in writing prior to commencement of the Work. The Contractor may then effect insurance that will protect the interests of the Contractor, Subcontractors and Sub-subcontractors in the Work, and by appropriate Change Order the cost thereof shall be charged to the Owner. If the Contractor is damaged by the failure or neglect of the Owner to purchase or maintain insurance as described above, without so notifying the Contractor in writing, then the Owner shall bear all reasonable costs properly attributable thereto.

§ 11.3.1.3 If the property insurance requires deductibles, the ~~Owner~~ Contractor shall pay costs not covered because of such deductibles.

§ 11.3.1.4 This property insurance shall cover portions of the Work stored off the site, and also portions of the Work in transit.

~~§ 11.3.1.5 Partial occupancy or use in accordance with Section 9.9 shall not commence until the insurance company or companies providing property insurance have consented to such partial occupancy or use by endorsement or otherwise. The Owner and the Contractor shall take reasonable steps to obtain consent of the insurance company or companies and shall, without mutual written consent, take no action with respect to partial occupancy or use that would cause cancellation, lapse or reduction of insurance.~~

#### ~~§ 11.3.2 BOILER AND MACHINERY INSURANCE~~

~~The Owner shall purchase and maintain boiler and machinery insurance required by the Contract Documents or by law, which shall specifically cover such insured objects during installation and until final acceptance by the Owner; this insurance shall include interests of the Owner, Contractor, Subcontractors and Sub-subcontractors in the Work, and the Owner and Contractor shall be named insureds.~~

#### ~~§ 11.3.3 LOSS OF USE INSURANCE~~

~~The Owner, at the Owner's option, may purchase and maintain such insurance as will insure the Owner against loss of use of the Owner's property due to fire or other hazards, however caused. The Owner waives all rights of action against the Contractor for loss of use of the Owner's property, including consequential losses due to fire or other hazards however caused.~~

~~§ 11.3.4 If the Contractor requests in writing that insurance for risks other than those described herein or other special causes of loss be included in the property insurance policy, the Owner shall, if possible, include such insurance, and the cost thereof shall be charged to the Contractor by appropriate Change Order.~~

~~§ 11.3.5 If during the Project construction period the Owner insures properties, real or personal or both, at or adjacent to the site by property insurance under policies separate from those insuring the Project, or if after final payment property insurance is to be provided on the completed Project through a policy or policies other than those insuring the Project during the construction period, the Owner shall waive all rights in accordance with the terms of Section 11.3.7 for damages caused by fire or other causes of loss covered by this separate property insurance. All separate policies shall provide this waiver of subrogation by endorsement or otherwise.~~

~~§ 11.3.6 Before an exposure to loss may occur, the Owner shall file with the Contractor a copy of each policy that includes insurance coverages required by this Section 11.3. Each policy shall contain all generally applicable~~

Init.

AIA Document A201™ – 2007. Copyright © 1911, 1915, 1918, 1925, 1937, 1951, 1958, 1961, 1963, 1966, 1970, 1976, 1987, 1997 and 2007 by The American Institute of Architects. All rights reserved. WARNING: This AIA® Document is protected by U.S. Copyright Law and International Treaties. Unauthorized reproduction or distribution of this AIA® Document, or any portion of it, may result in severe civil and criminal penalties, and will be prosecuted to the maximum extent possible under the law. This document was produced by AIA software at 15:13:02 on 07/19/2017 under Order No.7986168957\_1 which expires on 08/01/2017, and is not for resale.

User Notes:

(1383216234)

conditions, definitions, exclusions and endorsements related to this Project. Each policy shall contain a provision that the policy will not be canceled or allowed to expire, and that its limits will not be reduced, until at least 30 days' prior written notice has been given to the Contractor.

#### **§ 11.3.7 WAIVERS OF SUBROGATION**

The Owner and Contractor waive all rights against (1) each other and any of their subcontractors, sub-subcontractors, agents and employees, each of the other, and (2) the Architect, Architect's consultants, separate contractors described in Article 6, if any, and any of their subcontractors, sub-subcontractors, agents and employees, for damages caused by fire or other causes of loss to the extent covered by property insurance obtained pursuant to this Section 11.3 or other property insurance applicable to the Work, except such rights as they have to proceeds of such insurance held by the Owner as fiduciary. The Owner or Contractor, as appropriate, shall require of the Architect, Architect's consultants, separate contractors described in Article 6, if any, and the subcontractors, sub-subcontractors, agents and employees of any of them, by appropriate agreements, written where legally required for validity, similar waivers each in favor of other parties enumerated herein. The policies shall provide such waivers of subrogation by endorsement or otherwise. A waiver of subrogation shall be effective as to a person or entity even though that person or entity would otherwise have a duty of indemnification, contractual or otherwise, did not pay the insurance premium directly or indirectly, and whether or not the person or entity had an insurable interest in the property damaged.

~~§ 11.3.8 A loss insured under the Owner's property insurance shall be adjusted by the Owner as fiduciary and made payable to the Owner as fiduciary for the insureds, as their interests may appear, subject to requirements of any applicable mortgagee clause and of Section 11.3.10. The Contractor shall pay Subcontractors their just shares of insurance proceeds received by the Contractor, and by appropriate agreements, written where legally required for validity, shall require Subcontractors to make payments to their Sub-subcontractors in similar manner.~~

~~§ 11.3.9 If required in writing by a party in interest, the Owner as fiduciary shall, upon occurrence of an insured loss, give bond for proper performance of the Owner's duties. The cost of required bonds shall be charged against proceeds received as fiduciary. The Owner shall deposit in a separate account proceeds so received, which the Owner shall distribute in accordance with such agreement as the parties in interest may reach, or as determined in accordance with the method of binding dispute resolution selected in the Agreement between the Owner and Contractor. If after such loss no other special agreement is made and unless the Owner terminates the Contract for convenience, replacement of damaged property shall be performed by the Contractor after notification of a Change in the Work in accordance with Article 7.~~

~~§ 11.3.10 The Owner as fiduciary shall have power to adjust and settle a loss with insurers unless one of the parties in interest shall object in writing within five days after occurrence of loss to the Owner's exercise of this power; if such objection is made, the dispute shall be resolved in the manner selected by the Owner and Contractor as the method of binding dispute resolution in the Agreement. If the Owner and Contractor have selected arbitration as the method of binding dispute resolution, the Owner as fiduciary shall make settlement with insurers or, in the case of a dispute over distribution of insurance proceeds, in accordance with the directions of the arbitrators.~~

#### **§ 11.4 PERFORMANCE BOND AND PAYMENT BOND**

~~§ 11.4.1 The Owner shall have the right to require the Contractor to Contractor shall furnish bonds covering faithful performance of the Contract and payment of obligations arising thereunder as stipulated in bidding requirements or specifically required in the Contract Documents on the date of execution of the Contract thereunder.~~

~~§ 11.4.2 Upon the request of any person or entity appearing to be a potential beneficiary of bonds covering payment of obligations arising under the Contract, the Contractor shall promptly furnish a copy of the bonds or shall authorize a copy to be furnished.~~

~~11.4.3. The Labor and Material Payment Bond and Performance Bond shall each be for one hundred percent (100%) of the Contract price if the Contract Price is greater than \$10,000.00~~

- ~~1. Cost of the bonds shall be included in the bid.~~
- ~~2. Bonds shall be submitted with the executed agreement on provided form(s).~~

3. Power of Attorney is required for both bonds.
4. A Surety authorized to do business in the State of Alabama shall furnish both bonds.
5. A Surety licensed to do business in the State of Alabama must execute the bonds.
6. Each bond must be signed or countersigned by a Resident Agent of the State of Alabama.
7. The Surety must have a minimum rating of A/Class VI as reported in the latest issue of Best's Key Rating Guide Property-Casualty, published by Alfred M. Best Company, Inc., if the bid price exceeds \$50,000.00.
8. The Surety company shall be required to execute AIA Document G-707, "Consent of Surety to Final Payment" prior to Final Payment being made to the Contractor.

**ARTICLE 12 UNCOVERING AND CORRECTION OF WORK**

**§ 12.1 UNCOVERING OF WORK**

§ 12.1.1 If a portion of the Work is covered contrary to the Architect's request or to requirements specifically expressed in the Contract Documents, it must, if requested in writing by the Architect, be uncovered for the Architect's examination and be replaced at the Contractor's expense without change in the Contract Time.

§ 12.1.2 If a portion of the Work has been covered that the Architect has not specifically requested to examine prior to its being covered, the Architect may request to see such Work and it shall be uncovered by the Contractor. If such Work is in accordance with the Contract Documents, costs of uncovering and replacement shall, by appropriate Change Order, be at the Owner's expense. If such Work is not in accordance with the Contract Documents, such costs and the cost of correction shall be at the Contractor's expense unless the condition was caused by the Owner or a separate contractor in which event the Owner shall be responsible for payment of such costs.

**§ 12.2 CORRECTION OF WORK**

**§ 12.2.1 BEFORE OR AFTER SUBSTANTIAL COMPLETION**

The Contractor shall promptly correct Work rejected by the Architect or failing to conform to the requirements of the Contract Documents, whether discovered before or after Substantial Completion and whether or not fabricated, installed or completed. Costs of correcting such rejected Work, including additional testing and inspections, the cost of uncovering and replacement, and compensation for the Architect's services and expenses made necessary thereby, shall be at the Contractor's expense.

**§ 12.2.2 AFTER SUBSTANTIAL COMPLETION**

§ 12.2.2.1 In addition to the Contractor's obligations under Section 3.5, if, within one year after the date of Substantial Completion of the Work or designated portion thereof or after the date for commencement of warranties established under Section 9.9.1, or by terms of an applicable special warranty required by the Contract Documents, any of the Work is found to be not in accordance with the requirements of the Contract Documents, the Contractor shall correct it promptly after receipt of written notice from the Owner to do so unless the Owner has previously given the Contractor a written acceptance of such condition. The Owner shall give such notice promptly after discovery of the condition. During the one-year period for correction of Work, if the Owner fails to notify the Contractor and give the Contractor an opportunity to make the correction, the Owner waives the rights to require correction by the Contractor and to make a claim for breach of warranty. If the Contractor fails to correct nonconforming Work within a reasonable time during that period after receipt of notice from the Owner or Architect, the Owner may correct it in accordance with Section 2.4.

§ 12.2.2.2 The one-year period for correction of Work shall be extended with respect to portions of Work first performed after Substantial Completion by the period of time between Substantial Completion and the actual completion of that portion of the Work.

§ 12.2.2.3 The one-year period for correction of Work shall not be extended by corrective Work performed by the Contractor pursuant to this Section 12.2.

§ 12.2.3 The Contractor shall remove from the site portions of the Work that are not in accordance with the requirements of the Contract Documents and are neither corrected by the Contractor nor accepted by the Owner.

§ 12.2.4 The Contractor shall bear the cost of correcting destroyed or damaged construction, whether completed or partially completed, of the Owner or separate contractors caused by the Contractor's correction or removal of Work that is not in accordance with the requirements of the Contract Documents.

§ 12.2.5 Nothing contained in this Section 12.2 shall be construed to establish a period of limitation with respect to other obligations the Contractor has under the Contract Documents. Establishment of the one-year period for correction of Work as described in Section 12.2.2 relates only to the specific obligation of the Contractor to correct the Work, and has no relationship to the time within which the obligation to comply with the Contract Documents may be sought to be enforced, nor to the time within which proceedings may be commenced to establish the Contractor's liability with respect to the Contractor's obligations other than specifically to correct the Work.

### § 12.3 ACCEPTANCE OF NONCONFORMING WORK

If the Owner prefers to accept Work that is not in accordance with the requirements of the Contract Documents, the Owner may do so instead of requiring its removal and correction, in which case the Contract Sum will be reduced as appropriate and equitable. Such adjustment shall be effected whether or not final payment has been made.

## ARTICLE 13 MISCELLANEOUS PROVISIONS

### § 13.1 GOVERNING LAW

The Contract shall be governed by the law of the place where the Project is located except that, if the parties have selected arbitration as the method of binding dispute resolution, the Federal Arbitration Act shall govern Section 15.4.

State of Alabama.

### § 13.2 SUCCESSORS AND ASSIGNS

§ 13.2.1 The Owner and Contractor respectively bind themselves, their partners, successors, assigns and legal representatives to covenants, agreements and obligations contained in the Contract Documents. Except as provided in Section 13.2.2, neither party to the Contract shall assign the Contract as a whole without written consent of the other. If either party attempts to make such an assignment without such consent, that party shall nevertheless remain legally responsible for all obligations under the Contract.

§ 13.2.2 The Owner may, without consent of the Contractor, assign the Contract to a lender providing construction financing for the Project, if the lender assumes the Owner's rights and obligations under the Contract Documents. The Contractor shall execute all consents reasonably required to facilitate such assignment.

13.2.3 No assignment of the Contract shall be made without the written permission of Surety providing bonding and the City of Mobile.

### § 13.3 WRITTEN NOTICE

Written notice shall be deemed to have been duly served if delivered in person to the individual, to a member of the firm or entity, or to an officer of the corporation for which it was intended; or if delivered at, or sent by registered or certified mail or by courier service providing proof of delivery to, the last business address known to the party giving notice.

### § 13.4 RIGHTS AND REMEDIES

§ 13.4.1 Duties and obligations imposed by the Contract Documents and rights and remedies available thereunder shall be in addition to and not a limitation of duties, obligations, rights and remedies otherwise imposed or available by law.

§ 13.4.2 No action or failure to act by the Owner, Architect or Contractor shall constitute a waiver of a right or duty afforded them under the Contract, nor shall such action or failure to act constitute approval of or acquiescence in a breach there under, except as may be specifically agreed in writing.

### § 13.5 TESTS AND INSPECTIONS

§ 13.5.1 Tests, inspections and approvals of portions of the Work shall be made as required by the Contract Documents and by applicable laws, statutes, ordinances, codes, rules and regulations or lawful orders of public authorities. Unless otherwise provided, the Contractor shall make arrangements for such tests, inspections and approvals with an independent testing laboratory or entity acceptable to the Owner, or with the appropriate public

authority, and shall bear all related costs of tests, inspections and approvals. The Contractor shall give the Architect timely notice of when and where tests and inspections are to be made so that the Architect may be present for such procedures. The Owner shall bear costs of (1) tests, inspections or approvals that do not become requirements until after bids are received or negotiations concluded, and (2) tests, inspections or approvals where building codes or applicable laws or regulations prohibit the Owner from delegating their cost to the Contractor.

§ 13.5.2 If the Architect, Owner or public authorities having jurisdiction determine that portions of the Work require additional testing, inspection or approval not included under Section 13.5.1, the Architect will, upon written authorization from the Owner, instruct the Contractor to make arrangements for such additional testing, inspection or approval by an entity acceptable to the Owner, and the Contractor shall give timely notice to the Architect of when and where tests and inspections are to be made so that the Architect may be present for such procedures. Such costs, except as provided in Section 13.5.3, shall be at the Owner's expense.

§ 13.5.3 If such procedures for testing, inspection or approval under Sections 13.5.1 and 13.5.2 reveal failure of the portions of the Work to comply with requirements established by the Contract Documents, all costs made necessary by such failure including those of repeated procedures and compensation for the Architect's services and expenses shall be at the Contractor's expense.

§ 13.5.4 Required certificates of testing, inspection or approval shall, unless otherwise required by the Contract Documents, be secured by the Contractor and promptly delivered to the Architect.

§ 13.5.5 If the Architect is to observe tests, inspections or approvals required by the Contract Documents, the Architect will do so promptly and, where practicable, at the normal place of testing.

§ 13.5.6 Tests or inspections conducted pursuant to the Contract Documents shall be made promptly to avoid unreasonable delay in the Work.

13.5.7 Test, inspections or approvals made in addition to the Architects normal design and contract administration services caused by the Contractor shall be paid for by the Contractor. The normal service schedule is contained in Article 2.8.1 of AIA B102-2007 as amended by the Owner and is available to Contractor on request.

13.5.8 The Contractor must call the Urban Development Department of the City of Mobile for their inspections and approval at the times required by the Urban Development Department, as well as notify the Architect, Consulting Engineer, and/or Test Laboratory, for inspection and approval of sub-grade conditions, under slab and footing Conditions, vapor barrier placement, reinforcing steel placement, all structural connections, electrical, mechanical, etc. None of the above will be accepted that have been covered up before receiving approval of the Architect or his Consultant.

#### § 13.6 INTEREST

~~Payments due and unpaid under the Contract Documents shall bear interest from the date payment is due at such rate as the parties may agree upon in writing or, in the absence thereof, at the legal rate prevailing from time to time at the place where the Project is located.~~

#### § 13.7 TIME LIMITS ON CLAIMS

The Owner and Contractor shall commence all claims and causes of action, whether in contract, tort, breach of warranty or otherwise, against the other arising out of or related to the Contract in accordance with the requirements of the final dispute resolution method selected in the Agreement within the time period specified by applicable law, but in any case not more than 10 years after the date of Substantial Completion of the Work. The Owner and Contractor waive all claims and causes of action not commenced in accordance with this Section 13.7.

#### 13.8 COMMENCEMENT OF STATUTORY LIMITATION PERIOD

##### 13.8.1 As between the Owner and Contractor:

1. Before Substantial Completion. As to acts or failures to act occurring prior to the relevant date of Substantial Completion, any applicable statute of limitations shall commence to run and any alleged cause of action shall be deemed to have accrued in any and all events not later than such date of Substantial Completion;

2. Between Substantial Completion and Final Payment. As to acts or failures to act occurring subsequent to the relevant date of Substantial Completion and prior to the final payment, any applicable statute of limitations shall commence to run and any alleged cause of action shall be deemed to have accrued in any and all event not later than the date of issuance of the final Certificate for Payment; and
3. After Final Payment. As to acts or failures to act occurring after the relevant date of the final Payment, any applicable statute of limitations shall commence to run and any alleged cause of action shall be deemed to have accrued in any and all events not later than the date of any act or failure to act by the Contractor pursuant to any Warranty provided under Section 3.5, the date of any correction of the Work or failure to correct the Work by the Contractor under Section 3.5, the date of any correction of the Work or failure to correct the Work by the Contractor under Section 12.2, or the date of actual commission of any other act or failure to perform any duty or obligation by the Contractor or Owner, whichever occurs last.

### 13.9 SUBSTITUTION OF MATERIALS AND EQUIPMENT

13.9.1 Whenever a material, article or piece of equipment is identified on the Drawings or in the Specifications by reference to manufacturer's or vendor's names, trade names, catalog numbers, or the like, it is so identified for the purpose of establishing a standard, and any material, article, or piece of equipment of other manufacturers or vendors which will perform adequately the duties imposed by the general design will be considered equally acceptable provided the material, article, or piece of equipment so proposed is, in the opinion of the Architect, of equal substance, appearance and function. It shall not be purchased or installed by the Contractor without the Architect's written approval.

## **ARTICLE 14 TERMINATION OR SUSPENSION OF THE CONTRACT**

### **§ 14.1 TERMINATION BY THE CONTRACTOR**

**§ 14.1.1** The Contractor may terminate the Contract if the Work is stopped for a period of 30 consecutive days through no act or fault of the Contractor or a Subcontractor, Sub-subcontractor or their agents or employees or any other persons or entities performing portions of the Work under direct or indirect contract with the Contractor, for any of the following reasons:

1. Issuance of an order of a court or other public authority having jurisdiction that requires all Work to be stopped;
2. An act of government, such as a declaration of national emergency that requires all Work to be stopped;
3. Because the Architect has not issued a Certificate for Payment and has not notified the Contractor of the reason for withholding certification as provided in Section 9.4.1, or because the Owner has not made payment on a Certificate for Payment within the time stated in the Contract Documents; or
4. The Owner has failed to furnish to the Contractor promptly, upon the Contractor's request, reasonable evidence as required by Section 2.2.1.

**§ 14.1.2** The Contractor may terminate the Contract if, through no act or fault of the Contractor or a Subcontractor, Sub-subcontractor or their agents or employees or any other persons or entities performing portions of the Work under direct or indirect contract with the Contractor, repeated suspensions, delays or interruptions of the entire Work by the Owner as described in Section 14.3 constitute in the aggregate more than 100 percent of the total number of days scheduled for completion, or 120 days in any 365-day period, whichever is less.

**§ 14.1.3** If one of the reasons described in Section 14.1.1 or 14.1.2 exists, the Contractor may, upon seven days' written notice to the Owner and Architect, terminate the Contract and recover from the Owner payment for Work executed, including reasonable overhead and profit, costs incurred by reason of such termination, and damages executed.

**§ 14.1.4** If the Work is stopped for a period of 60 consecutive days through no act or fault of the Contractor or a Subcontractor or their agents or employees or any other persons performing portions of the Work under contract with the Contractor because the Owner has repeatedly failed to fulfill the Owner's obligations under the Contract Documents with respect to matters important to the progress of the Work, the Contractor may, upon seven additional days' written notice to the Owner and the Architect, terminate the Contract and recover from the Owner as provided in Section 14.1.3.



## § 14.2 TERMINATION BY THE OWNER FOR CAUSE

§ 14.2.1 The Owner may terminate the Contract if the Contractor

- .1 repeatedly refuses or fails to supply enough properly skilled workers or proper materials;
- .2 fails to make payment to Subcontractors for materials or labor in accordance with the respective agreements between the Contractor and the Subcontractors;
- .3 repeatedly disregards applicable laws, statutes, ordinances, codes, rules and regulations, or lawful orders of a public authority; or
- .4 otherwise is guilty of substantial breach of a provision of the Contract Documents.

§ 14.2.2 When any of the above reasons exist, the Owner, upon certification by the Initial Decision Maker that sufficient cause exists to justify such action, may without prejudice to any other rights or remedies of the Owner and after giving the Contractor and the Contractor's surety, if any, seven days' written notice, terminate employment of the Contractor and may, subject to any prior rights of the surety:

- .1 Exclude the Contractor from the site and take possession of all materials, equipment, tools, and construction equipment and machinery thereon owned by the Contractor;
- .2 Accept assignment of subcontracts pursuant to Section 5.4; and
- .3 Finish the Work by whatever reasonable method the Owner may deem expedient. Upon written request of the Contractor, the Owner shall furnish to the Contractor a detailed accounting of the costs incurred by the Owner in finishing the Work.

§ 14.2.3 When the Owner terminates the Contract for one of the reasons stated in Section 14.2.1, the Contractor shall not be entitled to receive further payment until the Work is finished.

§ 14.2.4 If the unpaid balance of the Contract Sum exceeds costs of finishing the Work, including compensation for the Architect's services and expenses made necessary thereby, and other damages incurred by the Owner and not expressly waived, such excess shall be paid to the Contractor. If such costs and damages exceed the unpaid balance, the Contractor shall pay the difference to the Owner. The amount to be paid to the Contractor or Owner, as the case may be, shall be certified by the Initial Decision Maker, upon application, and this obligation for payment shall survive termination of the Contract.

## § 14.3 SUSPENSION BY THE OWNER FOR CONVENIENCE

§ 14.3.1 The Owner may, without cause, order the Contractor in writing to suspend, delay or interrupt the Work in whole or in part for such period of time as the Owner may determine.

§ 14.3.2 The Contract Sum and Contract Time shall ~~may~~ be adjusted for increases in the cost and time caused by suspension, delay or interruption as described in Section 14.3.1. Adjustment of the Contract Sum shall include profit. No adjustment shall be made to the extent

- .1 that performance is, was or would have been so suspended, delayed or interrupted by another cause for which the Contractor is responsible; or
- .2 that an equitable adjustment is made or denied under another provision of the Contract.

## § 14.4 TERMINATION BY THE OWNER FOR CONVENIENCE

§ 14.4.1 The Owner may, at any time, terminate the Contract for the Owner's convenience and without cause.

§ 14.4.2 Upon receipt of written notice from the Owner of such termination for the Owner's convenience, the Contractor shall

- .1 cease operations as directed by the Owner in the notice;
- .2 take actions necessary, or that the Owner may direct, for the protection and preservation of the Work; and
- .3 except for Work directed to be performed prior to the effective date of termination stated in the notice, terminate all existing subcontracts and purchase orders and enter into no further subcontracts and purchase orders.

§ 14.4.3 In case of such termination for the Owner's convenience, the Contractor shall be entitled to receive payment for Work executed, and costs incurred by reason of such termination, ~~along with reasonable overhead and profit on the Work not executed.~~ termination.



## ARTICLE 15 CLAIMS AND DISPUTES

### § 15.1 CLAIMS

#### § 15.1.1 DEFINITION

A Claim is a demand or assertion by one of the parties seeking, as a matter of right, payment of money, or other relief with respect to the terms of the Contract. The term "Claim" also includes other disputes and matters in question between the Owner and Contractor arising out of or relating to the Contract. The responsibility to substantiate Claims shall rest with the party making the Claim.

#### § 15.1.2 NOTICE OF CLAIMS

Claims by either the Owner or Contractor must be initiated by written notice to the other party and to the Initial Decision Maker with a copy sent to the Architect, if the Architect is not serving as the Initial Decision Maker. ~~Claims by either party must be initiated within 21 days after occurrence of the event giving rise to such Claim or within 21 days after the claimant first recognizes acting with due diligence, reasonable should have first recognized the condition giving rise to the Claim, whichever is later. Claims must be initiated by written notice to the Architect and the other party.~~

#### § 15.1.3 CONTINUING CONTRACT PERFORMANCE

Pending final resolution of a Claim, except as otherwise agreed in writing or as provided in Section 9.7 and Article 14, the Contractor shall proceed diligently with performance of the Contract and the Owner shall continue to make payments in accordance with the Contract Documents. The Architect will prepare Change Orders and issue Certificates for Payment in accordance with the decisions of the Initial Decision Maker.

#### § 15.1.4 CLAIMS FOR ADDITIONAL COST

If the Contractor wishes to make a Claim for an increase in the Contract Sum, written notice as provided herein shall be given before proceeding to execute the ~~Work-Work~~ giving rise to such claim. Prior notice is not required for Claims relating to an emergency endangering life or property arising under Section 10.4.

#### § 15.1.5 CLAIMS FOR ADDITIONAL TIME

§ 15.1.5.1 If the Contractor wishes to make a Claim for an increase in the Contract Time, written notice as provided herein shall be given. The Contractor's Claim shall include an estimate of cost and of probable effect of delay on progress of the Work. In the case of a continuing delay, only one Claim is necessary.

§ 15.1.5.2 If adverse weather conditions are the basis for a Claim for additional time, such Claim shall be documented by data substantiating that weather conditions were abnormal for the period of time, could not have been reasonably anticipated and had an adverse effect on the scheduled construction.

#### § 15.1.6 CLAIMS FOR CONSEQUENTIAL DAMAGES

The Contractor and Owner waive Claims against each other for consequential damages arising out of or relating to this Contract. This mutual waiver includes

- 1 damages incurred by the Owner for rental expenses, for losses of use, income, profit, financing, business and reputation, and for loss of management or employee productivity or of the services of such persons; and
- 2 damages incurred by the Contractor for principal office expenses including the compensation of personnel stationed there, for losses of financing, business and reputation, and for loss of profit except anticipated profit arising directly from the Work.

This mutual waiver is applicable, without limitation, to all consequential damages due to either party's termination in accordance with Article 14. Nothing contained in this Section 15.1.6 shall be deemed to preclude an award of liquidated damages, when applicable, in accordance with the requirements of the Contract Documents.

### § 15.2 INITIAL DECISION

§ 15.2.1 Claims, excluding those arising under Sections 10.3, 10.4, 11.3.9, and 11.3.10, shall be referred to the Initial Decision Maker for initial decision. The Architect will serve as the Initial Decision Maker, unless otherwise indicated in the Agreement. Except for those Claims excluded by this Section 15.2.1, an initial decision shall be required as a condition precedent to mediation of any Claim arising prior to the date final payment is due, unless 30 days have passed after the Claim has been referred to the Initial Decision Maker with no decision having been

rendered. Unless the Initial Decision Maker and all affected parties agree, the Initial Decision Maker will not decide disputes between the Contractor and persons or entities other than the Owner.

§ 15.2.2 ~~The Initial Decision Maker Architect~~ will review Claims and within ten days of the receipt of a Claim take one or more of the following actions: (1) request additional supporting data from the claimant or a response with supporting data from the other party, (2) reject the Claim in whole or in part, (3) approve the Claim, (4) suggest a compromise, or (5) advise the parties that the Initial Decision Maker is unable to resolve the Claim if the Initial Decision Maker lacks sufficient information to evaluate the merits of the Claim or if the ~~Initial Decision Maker concludes that, in the Initial Decision Maker's sole discretion, Architect reasonably concludes that,~~ it would be inappropriate for the Initial Decision Maker to resolve the Claim.

§ 15.2.3 In evaluating Claims, the Initial Decision Maker may, but shall not be obligated to, consult with or seek information from either party or from persons with special knowledge or expertise who may assist the Initial Decision Maker in rendering a decision. The Initial Decision Maker may request the Owner to authorize retention of such persons at the Owner's expense.

§ 15.2.4 If the Initial Decision Maker requests a party to provide a response to a Claim or to furnish additional supporting data, such party shall respond, within ten days after receipt of such request, and shall either (1) provide a response on the requested supporting data, (2) advise the Initial Decision Maker when the response or supporting data will be furnished or (3) advise the Initial Decision Maker that no supporting data will be furnished. Upon receipt of the response or supporting data, if any, the Initial Decision Maker will either reject or approve the Claim in whole or in part.

§ 15.2.5 The Initial Decision Maker will render an initial decision approving or rejecting the Claim, or indicating that the Initial Decision Maker is unable to resolve the Claim. This initial decision shall (1) be in writing; (2) state the reasons therefor; ~~therefore;~~ and (3) notify the parties and the Architect, if the Architect is not serving as the Initial Decision Maker, of any change in the Contract Sum or Contract Time or both. The initial decision shall be final and binding on the parties ~~but subject to mediation and, if the parties fail to resolve their dispute through mediation, to binding dispute resolution.~~

~~§ 15.2.6 Either party may file for mediation of an initial decision at any time, subject to the terms of Section 15.2.6.1.~~

~~§ 15.2.6.1 Either party may, within 30 days from the date of an initial decision, demand in writing that the other party file for mediation within 60 days of the initial decision. If such a demand is made and the party receiving the demand fails to file for mediation within the time required, then both parties waive their rights to mediate or pursue binding dispute resolution proceedings with respect to the initial decision.~~

§ 15.2.7 In the event of a Claim against the Contractor, the Owner may, but is not obligated to, notify the surety, if any, of the nature and amount of the Claim. If the Claim relates to a possibility of a Contractor's default, the Owner may, but is not obligated to, notify the surety and request the surety's assistance in resolving the controversy.

§ 15.2.8 If a Claim relates to or is the subject of a mechanic's lien, the party asserting such Claim may proceed in accordance with applicable law to comply with the lien notice or filing deadlines.

### § 15.3 MEDIATION

§ 15.3.1 Claims, disputes, or other matters in controversy arising out of or related to the Contract except those waived as provided for in Sections 9.10.4, 9.10.5, and 15.1.6 shall not be subject to mediation as a condition precedent to binding dispute resolution.

~~§ 15.3.2 The parties shall endeavor to resolve their Claims by mediation which, unless the parties mutually agree otherwise, shall be administered by the American Arbitration Association in accordance with its Construction Industry Mediation Procedures in effect on the date of the Agreement. A request for mediation shall be made in~~

Init.

AIA Document A201™ – 2007. Copyright © 1911, 1915, 1918, 1925, 1937, 1951, 1958, 1961, 1963, 1966, 1970, 1976, 1987, 1997 and 2007 by The American Institute of Architects. All rights reserved. WARNING: This AIA® Document is protected by U.S. Copyright Law and International Treaties. Unauthorized reproduction or distribution of this AIA® Document, or any portion of it, may result in severe civil and criminal penalties, and will be prosecuted to the maximum extent possible under the law. This document was produced by AIA software at 15:13:02 on 07/19/2017 under Order No.7986168957\_1 which expires on 08/01/2017, and is not for resale.

User Notes:

(1383216234)

writing, delivered to the other party to the Contract, and filed with the person or entity administering the mediation. The request may be made concurrently with the filing of binding dispute resolution proceedings but, in such event, mediation shall proceed in advance of binding dispute resolution proceedings, which shall be stayed pending mediation for a period of 60 days from the date of filing, unless stayed for a longer period by agreement of the parties or court order. If an arbitration is stayed pursuant to this Section 15.3.2, the parties may nonetheless proceed to the selection of the arbitrator(s) and agree upon a schedule for later proceedings.

~~§ 15.3.3~~ The parties shall share the mediator's fee and any filing fees equally. The mediation shall be held in the place where the Project is located, unless another location is mutually agreed upon. Agreements reached in mediation shall be enforceable as settlement agreements in any court having jurisdiction thereof.

#### ~~§ 15.4~~ ARBITRATION

~~§ 15.4.1~~ If the parties have selected arbitration as the method for binding dispute resolution in the Agreement, any Claim subject to, but not resolved by, mediation shall be subject to arbitration which, unless the parties mutually agree otherwise, shall be administered by the American Arbitration Association in accordance with its Construction Industry Arbitration Rules in effect on the date of the Agreement. A demand for arbitration shall be made in writing, delivered to the other party to the Contract, and filed with the person or entity administering the arbitration. The party filing a notice of demand for arbitration must assert in the demand all Claims then known to that party on which arbitration is permitted to be demanded.

~~§ 15.4.1.1~~ A demand for arbitration shall be made no earlier than concurrently with the filing of a request for mediation, but in no event shall it be made after the date when the institution of legal or equitable proceedings based on the Claim would be barred by the applicable statute of limitations. For statute of limitations purposes, receipt of a written demand for arbitration by the person or entity administering the arbitration shall constitute the institution of legal or equitable proceedings based on the Claim.

~~§ 15.4.2~~ The award rendered by the arbitrator or arbitrators shall be final, and judgment may be entered upon it in accordance with applicable law in any court having jurisdiction thereof.

~~§ 15.4.3~~ The foregoing agreement to arbitrate and other agreements to arbitrate with an additional person or entity duly consented to by parties to the Agreement shall be specifically enforceable under applicable law in any court having jurisdiction thereof.

#### ~~§ 15.4.4~~ CONSOLIDATION OR JOINDER

~~§ 15.4.4.1~~ Either party, at its sole discretion, may consolidate an arbitration conducted under this Agreement with any other arbitration to which it is a party provided that (1) the arbitration agreement governing the other arbitration permits consolidation, (2) the arbitrations to be consolidated substantially involve common questions of law or fact, and (3) the arbitrations employ materially similar procedural rules and methods for selecting arbitrator(s).

~~§ 15.4.4.2~~ Either party, at its sole discretion, may include by joinder persons or entities substantially involved in a common question of law or fact whose presence is required if complete relief is to be accorded in arbitration, provided that the party sought to be joined consents in writing to such joinder. Consent to arbitration involving an additional person or entity shall not constitute consent to arbitration of any claim, dispute or other matter in question not described in the written consent.

~~§ 15.4.4.3~~ The Owner and Contractor grant to any person or entity made a party to an arbitration conducted under this Section 15.4, whether by joinder or consolidation, the same rights of joinder and consolidation as the Owner and Contractor under this Agreement.

## SECTION 01010

### SUMMARY OF THE WORK

#### PART 1 GENERAL

##### 1.1 SECTION INCLUDES

- A. Summary of Work: Contract, contractor use of premises.
- B. Contract Considerations: Contingency allowance, schedule of values, applications for payment, change procedures, alternates.
- C. Coordination and Meetings: Coordination, field engineering, cutting and patching, meetings, progress meetings, examination, preparation.
- D. Submittals: Submittal procedures, construction progress schedules, proposed products list, shop drawings, product data, samples, manufacturers' installation instructions, manufacturers' certificates.
- E. Quality Control: Quality assurance - control of installation, Tolerances, References, Mock-ups, Manufacturers' field services and reports.
- F. Construction Facilities and Temporary Controls: Electricity, temporary lighting for construction purposes, heat, temporary ventilation, telephone service, water service, temporary sanitary facilities, barriers and fencing, exterior enclosures, protection of installed work, security, access roads, parking, progress cleaning and waste removal, project identification, field offices and sheds, removal of utilities, facilities, and controls.
- G. Material and Equipment: Products, transportation, handling, storage, and protection, products options, substitutions.
- H. Contract Closeout: Contract closeout procedures, final cleaning, adjusting, project record documents, operation and maintenance data, spare parts and maintenance materials, warranties.

##### 1.2 CONTRACT

- A. Summary of Work:  
Base Bid: The project shall include providing and installing site work and utilities necessary for a temporary modular building.
- B. Contract Description: Stipulated sum.

##### 1.3 CONTRACTOR USE OF PREMISES

- A. Limit use of premises to allow continued Owner occupancy. All facilities shall remain in use except the immediate work area for this project. Obey all Facility Regulations and coordinate access and schedule of work with Project Manager.

#### 1.4 CONTINGENCY ALLOWANCE

- A. Include in the Contract the stipulated amount for use upon Owner's instruction.
- B. Contractor's costs for products, delivery, installation, labor, insurance, payroll, taxes, bonding, equipment rental, overhead and profit are included in Change or Field Orders authorizing expenditure of funds from this Contingency Allowance.

#### 1.5 SCHEDULE OF VALUES

- A. Submit Schedule of Values on AIA Form G703 within five (5) calendar days of notification of project award.

#### 1.6 APPLICATIONS FOR PAYMENT

- A. Submit two signed and notarized originals of each application on AIA Form G702 and AIA Form G703. Submit Lien Release Waivers, including from subcontractors and major suppliers, with each pay application.
- B. Content and Format: Utilize Schedule of Values, AIA Form G703, for listing items in Application for Payment.
- C. Payment Period: Monthly, except for final payment of retainage after all Close Out documents are submitted and approved.

#### 1.7 CHANGE ORDER PROCEDURES

- A. All contract changes involving a change in scope, payment and/or time shall be made by change order.
- B. Stipulated Sum/Price Change Order: Based on Proposal Request and Contractor's fixed price quotation or Contractor's request for a Change Order as approved by Owner.

#### 1.8 ALTERNATE BID ITEMS

- A. Alternates quoted on Bid Form, if any, will be reviewed and accepted in the order listed.
- B. Coordinate related Work and modify surrounding Work as required.
- C. Schedule of Alternates: Listed on bid form, as applicable.

#### 1.9 COORDINATION

- A. Coordinate scheduling, submittals, and Work at the facility to ensure an efficient and orderly sequence and to facilitate the continued uninterrupted use of the Facility.
- B. Request Utility interruptions at least 72 hours in advance. Note that due to scheduling in the facility, utility interruptions must be approved.

#### 1.10 FIELD ENGINEERING

- A. Establish elevations, lines, and levels and certify that elevations and locations of the Work conform to the Contract Documents. Verify existing conditions.
- B. Contractor shall field verify all measurements and quantities required for a complete installation.

#### 1.11 PRECONSTRUCTION MEETINGS

- A. Owner will schedule a pre-construction meeting after contract award for all affected parties.

#### 1.12 PROGRESS MEETINGS

- A. Schedule and administer meetings throughout progress of the Work at pre-approved intervals.
- B. Preside at meetings, record minutes, and distribute copies within two days to those affected by decisions made.

#### 1.13 CONSTRUCTION PROGRESS SCHEDULES

- A. Submit initial progress schedule in duplicate within five (5) calendar days after date of notice of award of project for Project Manager's review.
- B. Submit revised schedules with each Application for Payment, identifying changes since previous version. Indicate estimated percentage of completion for each item of Work at each submission.

#### 1.14 SHOP DRAWINGS

- A. Shop Drawings for Review: Submit to Project Manager/Engineer for review for the limited purpose of checking for conformance with information given and the design concept expressed in the Contract Documents.
- B. Submit four copies for use by the owner plus the number of copies that Contractor requires. Electronic submittals may be acceptable with prior approval of the Project Manager and Engineer. Close Out documents shall include electronic and hard copies of all submittals.

#### 1.15 QUALITY ASSURANCE - CONTROL OF INSTALLATION

- A. Monitor quality control over suppliers, manufacturers, products, services, site conditions, and workmanship, to produce Work of specified quality.
- B. Comply with manufacturers' written instructions.
- C. Comply with specified standards as minimum quality for the Work except when more stringent tolerances, codes, or specified requirements indicate higher standards or more precise workmanship.

- D. Supply certification from manufacturer that the installed Work meets or exceeds all manufacturers' requirements.

#### 1.16 EXAMINATION

- A. Verify that existing site conditions and subsurfaces are acceptable for subsequent Work. Beginning new Work means acceptance of existing conditions.
- B. Verify that utility services are available, of the correct characteristics, and in the correct location.

#### 1.17 PREPARATION

- A. Prepare surfaces prior to applying next material installation.

#### 1.18 TOLERANCES

- A. Monitor fabrication and installation tolerance control of installed Products over suppliers, manufacturers, Products, site conditions, and workmanship, to produce acceptable Work. Do not permit tolerances to accumulate. Comply fully with manufacturers' tolerances.

#### 1.19 REFERENCES

- A. Conform to reference standards by date of issue current as of date of Contract Documents.
- B. Should specified reference standard conflict with Contract Documents, request clarification from Project Manager before proceeding.

#### 1.20 ELECTRICITY

- A. Unless otherwise provided for, Contractor shall be allowed to utilize power from the facility in moderate amounts.
- B. Provide power outlets for construction operations, branch wiring, distribution boxes, and flexible power cords as required.

#### 1.21 TEMPORARY LIGHTING FOR CONSTRUCTION PURPOSES

- A. Provide and maintain temporary lighting for construction operations as may be required.
- B. Provide branch wiring from power source to distribution boxes with lighting conductors, pigtails, and lamps as required.

#### 1.22 WATER SERVICE

- A. Owner shall provide suitable potable water in moderate quantities without cost to the Contractor.

### 1.23 TEMPORARY SANITARY FACILITIES

- A. Contractor will need to provide temporary sanitary facilities.

### 1.24 BARRIERS AND FENCING

- A. Provide barriers and fencing as needed to prevent unauthorized entry to construction areas and to protect existing facilities and adjacent properties from dust, debris and damage.

### 1.25 PROTECTION OF INSTALLED WORK

- A. Protect installed Work and provide special protection where specified in individual specification sections. Prohibit traffic or storage upon grass or paving surfaces.

### 1.26 SECURITY

- A. Provide security and facilities to protect Work and existing facilities from unauthorized entry, vandalism, or theft.

### 1.27 ACCESS ROADS & HAULING

- A. Maintain temporary access routes through the public thoroughfare and parking areas to serve the construction area as required without obstructing traffic or blocking access for facility staff or participants. Provide drive pads as required.
- B. Restore site to pre-construction condition. Fill ruts, replace broken or damaged amenities, sod disturbed areas.

### 1.28 PARKING

- A. Arrange for temporary parking areas to accommodate construction personnel on site. Do not block traffic.

### 1.29 PROGRESS CLEANING AND WASTE REMOVAL

- A. Collect and maintain work areas free of waste materials, debris, and rubbish on a daily basis. Maintain site in a clean and orderly condition. Provide refuse containers and dispose of construction debris legally off site. The Owner may request load tickets from landfills permitted to accept construction debris.

### 1.30 REMOVAL OF UTILITIES, FACILITIES, AND CONTROLS

- A. Remove temporary utilities, equipment, facilities and materials, prior to Substantial Completion review.
- B. Clean and repair damage caused by installation or use of temporary work.
- C. Restore existing facilities used during construction to original condition.



Restore permanent facilities used during construction to specified condition.

### 1.31 PRODUCTS

- A. Products: Means new material, machinery, components, equipment, fixtures, and systems forming the Work, but does not include machinery and equipment used for preparation, fabrication, conveying and erection of the Work.

### 1.32 TRANSPORTATION, HANDLING, STORAGE AND PROTECTION

- A. Transport, handle, store, and protect Products in accordance with manufacturers' instructions.

### 1.33 PRODUCT OPTIONS

- A. Products Specified by Naming One Manufacturer or equal: Products of manufacturer named approved as "Basis of Design". Equal alternate products to be approved by Owner as Substitutions. Submit product data as required in SUBSTITUTIONS.

### 1.34 SUBSTITUTIONS

- A. For Pre-Bid approved Substitutions, submit request 7 calendar days or more before bid date with all back up data to show that all characteristics of the Basis of Design product are met with the substituted product or material.
- B. Document each request with complete backup data substantiating compliance of proposed Substitution with all characteristics of the materials specified in the Contract Documents.
- C. Submit three copies of request for Substitution for consideration. Limit each request to one proposed Substitution.
- D. Substitution shall indicate all product properties and show that they are equal to that Specified.
- E. Acceptance or Rejection of Pre-Bid Substitution Requests will be issued by Addendum.

### 1.35 FINAL CLEANING

- A. Execute final cleaning prior to final inspection of work area. User may occupy portions of the work incrementally as the work is completed and accepted. Entire project to be ready for use by User once all areas of work are completed.
- B. Clean debris from site and drainage systems.
- C. Remove waste and surplus materials, rubbish, and construction facilities from the facility and the site. Leave site in raked and smooth condition.

### 1.36 PROJECT RECORD DOCUMENTS

- A. Maintain on site one set of Contract Documents to be utilized only for record documents.
- B. Record actual revisions to the Work. Record information concurrent with construction progress.
- C. Specifications: Legibly mark and record at each Product section a description of actual Products installed.
- D. Record Documents and Shop Drawings: Legibly mark each item to record actual construction.
- E. Submit documents to Project Manager with claim for final Application for Payment.
- F. Submit 1 paper copy and 1 disc with pdf copies to include:
  - a. As built drawings and specifications
  - b. Approved submittals
  - c. Warrantees and guarantees
  - d. Certificate of Occupancy or Letter of Completion from Permitting Department or other agencies, as applicable.

### 1.37 WARRANTIES

- A. Product and Manufacturer's Warranties shall be provided per specifications.
- B. In addition, all materials and labor shall be warranted for a minimum of one year after Substantial Completion of the entire project. Contractor to promptly repair all deficiencies within that time. A warranty inspection shall be scheduled by the Owner, with the Contractor and Owner's representative, before the end of the warranty period, in order to review the work and note deficiencies for the Contractor to correct. Said meeting may be waived if no deficiencies are noted.

PART 2 PRODUCTS  
Not Used.

PART 3 EXECUTION  
Not Used.

END OF SECTION

## **SECTION 01210 ALLOWANCES**

### **PART 1 GENERAL**

#### **1.1 RELATED DOCUMENTS**

Drawings and general provisions of the Contract, including General Conditions and Division 01 Specification Sections, apply to this Section.

#### **1.2 SUMMARY**

**A. Allowances will be utilized to:**

1. Defer selection of certain items until more information is available.
2. Provide for discretionary installation of materials where exact and specific conditions cannot be determined in advance.
3. Provide for the discretionary use of labor where tasks and time frames cannot be determined in advance.

**B. Include in Total Bid a stipulated lump sum allowance amount as specified in this Section.**

#### **1.3 ALLOWANCE**

**A. Include in the Total Base Quote a stipulated allowance(s) as indicated on the Quote Form for the use upon Owner's instruction. Upon Contractor inspection and Owner approval, any additional work that may be required, but not covered in the original Scope of Work (Base Scope Quote), shall be added to the scope and cost charged against the Contingency Allowance. Contractor's cost for products, delivery, installation labor, insurance, payroll, bonding, equipment rental and overhead and profit will be included in the Allowances. Contractor's markups on allowances are limited to 10% for subcontractor's work and 15% for his own forces.**

**B. Use of Contingency Allowance(s) shall be approved in writing by the Owner before any materials are ordered or work performed.**

**C. Upon completion of the Work, any unused portion of the Allowances shall be credited back to the City of Mobile in the form of a Change Order.**

**D. Contractor shall provide a detailed proposal of the work with overhead and profit broken out. Such proposals shall include proposals from subcontractors, also showing their detailed proposal with overhead and profit broken out.**

#### **1.4 SELECTION AND PURCHASE**

**A. Advise the Project Manager when final selection and purchase of allowance item must be complete to avoid delay.**

## 1.5 SUBMITTALS

- A. Request for Use of Allowance: Submit proposals for approval that detail and break out costs for contractors and subcontractor's markups.
- B. After Use of Allowance: Submit invoices to show quantity delivered to the site for each allowance.

## PART 2 PRODUCTS

Not used

## PART 3 EXECUTION

### 3.1 INSPECTION

- A. Promptly inspect all Allowance items upon delivery. Immediately report any shortage, damage, or defects to Project Manager.

### 3.2 PREPARATION

- A. Coordinate materials and installation to assure that each item is integrated with related construction activities.

### 3.3 ALLOWANCE SCHEDULE

- A. Include as a Contingency Allowance the lump sum amount of ten thousand and xx/100 Dollars (\$10,000.00).

END OF SECTION

**SECTION 01220  
UNIT PRICES**

**PART 1 GENERAL**

**1.1 RELATED DOCUMENTS**

Drawings and general provisions of the Contract, including General Conditions and Division 01 Specification Sections, apply to this Section.

**1.2 SUMMARY**

- A. Section Includes:
1. Measurement.
  2. Payment.

**1.3 UNIT PRICES**

- A. Provide unit prices for items listed, for inclusion in Contract, guaranteed to apply for duration of Project as basis for additions to or deductions from Contract Sum.
- B. Actual quantities and measurements supplied or placed in the Work will determine payment.
- C. Payment includes full compensation for all required labor, Products, tools, equipment, services, and incidentals, and for erection, application, or installation of an item of the Work.

**PART 2 PRODUCTS Not used**

**PART 3 EXECUTION**

**3.1 UNIT PRICE SCHEDULE**

- A. Provide labor and all other necessary construction components for installation of 1 Square Foot of asphalt surfacing.
1. Unit of measure: Per Square Foot.
  2. Basis of payment:
    - a. Contract Sum to be based on quantities material provided and installed.
    - b. Adjustments to Contract Sum will be made based on actual quantity of items provided to owner.
- B. Provide labor and all other necessary construction components for installation of 1 Square Foot of concrete surfacing.
1. Unit of measure: Per Square Foot.
  2. Basis of payment:
    - a. Contract Sum to be based on quantities material provided and installed.
    - b. Adjustments to Contract Sum will be made based on actual quantity of items provided to owner.

**END OF SECTION**

**SECTION 01310  
PROJECT MANAGEMENT AND COORDINATION**

**PART 1 - GENERAL**

**1.1 RELATED DOCUMENTS**

- A. Drawings and general provisions of the Contract, including General and Supplementary Conditions and other Division 1 Specification Sections, apply to this Section.

**1.2 SUMMARY**

- A. Section includes administrative provisions for coordinating construction operations on Project including, but not limited to, the following:
  - 1. General project coordination procedures.
  - 2. Administrative and supervisory personnel.
  - 3. Coordination drawings.
  - 4. Requests for Information (RFIs).
  - 5. Project meetings.
- B. Each contractor shall participate in coordination requirements. Certain areas of responsibility are assigned to a specific contractor.
- C. Related Sections:
  - 1. Division 1 Section "Execution Requirements"
  - 2. Division 1 Section "Project Record Drawings" for coordinating closeout of the Contract.

**1.3 DEFINITIONS**

- A. RFI: Request from Owner, Architect, or Contractor seeking information from each other during construction.

**1.4 COORDINATION**

- A. Contractor shall be responsible for coordinating all trades of his contract, Owners Contractors, coordinating construction sequences and schedules, and coordinating actual installed location and interface of work.
- B. Contractor shall supervise and direct the development of coordination drawings showing comprehensive coordination and integration of all Work of this project

including, but not limited to, structural, architectural mechanical, plumbing, fire protection, electrical disciplines, and Owners Contractors.

- C. Coordination drawings are intended to assist Contractor and all trades during construction and may be used to supplement shop drawings, record drawings, and other required submittals.
- D. Coordination: Each contractor shall supervise and direct construction operations with those of subcontractors and entities to ensure efficient and orderly installation of each part of the Work. Each contractor shall coordinate its operations with operations, included in different Sections that depend on each other for proper installation, connection, and operation.
  - 1. Schedule construction operations in sequence required to obtain the best results where installation of one part of the Work depends on installation of other components, before or after its own installation.
  - 2. Coordinate installation of different components with other contractors to ensure maximum performance and accessibility for required maintenance, service, and repair.
  - 3. Make adequate provisions to accommodate items scheduled for later installation.
- E. Prepare memoranda for distribution to each party involved, outlining special procedures required for coordination. Include such items as required notices, reports, and list of attendees at meetings.
  - 1. Prepare similar memoranda for Owner and separate contractors if coordination of their Work is required.
- F. Administrative Procedures: Coordinate scheduling and timing of required administrative procedures with other construction activities to avoid conflicts and to ensure orderly progress of the Work. Such administrative activities include, but are not limited to, the following:
  - 1. Preparation of Contractor's construction schedule.
  - 2. Preparation of the schedule of values.
  - 3. Installation and removal of temporary facilities and controls.
  - 4. Delivery and processing of submittals.
  - 5. Progress meetings.
  - 6. Pre-installation conferences.
  - 7. Project closeout activities.
  - 8. Startup and adjustment of systems.
  - 9. Project closeout activities.

## 1.5 KEY PERSONNEL

- A. Key Personnel Names: Within 5 days of Notice to Proceed, submit a list of key personnel assignments, including superintendent and other personnel in attendance at Project site. Identify individuals and their duties and responsibilities; list addresses and telephone numbers, including home, office, and cellular telephone numbers and email addresses. Provide names, addresses, and telephone numbers of individuals assigned as standbys in the absence of individuals assigned to Project.
  - 1. Post copies of list at site. Keep list current at all times.

## 1.6 REQUESTS FOR INFORMATION (RFIs)

- A. General: Immediately on discovery of the need for additional information or interpretation of the Contract Documents, Contractor shall prepare and submit an RFI in the form specified.
  - 1. Architect will return RFIs submitted to Architect by other entities controlled by Contractor with no response.
  - 2. Coordinate and submit RFIs in a prompt manner so as to avoid delays in Contractor's work or work of subcontractors.

## 1.7 PROJECT MEETINGS

- A. General: Attendance of subcontractors and superintendent at a weekly progress meeting is required.

PART 2 - PRODUCTS (Not Used)

PART 3 - EXECUTION (Not Used)

END OF SECTION



SECTION 01320  
CONSTRUCTION PROGRESS DOCUMENTATION

PART 1 - GENERAL

1.1 RELATED DOCUMENTS

- A. Drawings and general provisions of the Contract, including General and Supplementary Conditions and other Division 1 Specification Sections, apply to this Section.

1.2 SUMMARY

- A. Section includes administrative and procedural requirements for documenting the progress of construction during performance of the Work, including the following:
  - 1. Start-up construction schedule.
  - 2. Contractor's construction schedule.
  - 3. Field condition reports.
  - 4. Special reports.

1.3 INFORMATIONAL SUBMITTALS

- A. Format for Submittals: Submit required submittals in the following format:
  - 1. PDF electronic file.
- B. Start-up construction schedule.
  - 1. Approval of cost-loaded start-up construction schedule will not constitute approval of schedule of values for cost-loaded activities.
- C. Contractor's Construction Schedule: Initial schedule, of size required to display entire schedule for entire construction period.
- D. Field Condition Reports: Submit at time of discovery of differing conditions.
- E. Special Reports: Submit at time of unusual event.
- F. Existing Condition Photos: Submit prior to onsite mobilization to record existing conditions. If, during construction, damage occurs by others, notify Project Manager right away.

## PART 2 - PRODUCTS

### 2.1 CONTRACTOR'S CONSTRUCTION SCHEDULE, GENERAL

- A. Time Frame: Extend schedule from date established for the Notice to Proceed to date of final completion.
- B. Activities: Treat each story or separate area as a separate numbered activity for each principal element of the Work. Show the following:
  - 1. Activity Duration
  - 2. Procurement Activities: Include procurement process activities for long lead items and major items, requiring a cycle of more than 60 days, as separate activities in schedule. Procurement cycle activities include, but are not limited to, submittals, approvals, purchasing, fabrication, and delivery.
  - 3. Submittal Review Time: Include review and resubmittal times indicated in Division 1 Section "Submittal Procedures" in schedule. Coordinate submittal review times in Contractor's construction schedule with submittal schedule.
  - 4. Startup and Testing Time: Include not less than 15 days for startup and testing.
  - 5. Substantial Completion: Indicate completion in advance of date established for Substantial Completion, and allow time for Architect's administrative procedures necessary for certification of Substantial Completion.
- C. Constraints: Include constraints and work restrictions indicated in the Contract Documents and as follows in schedule, and show how the sequence of the Work is affected.
  - 1. Phasing: Arrange list of activities on schedule by phase.
  - 2. Work Restrictions: Show the effect of the following items on the schedule:
    - a. Coordination with existing construction.
    - b. Limitations of continued occupancies.
    - c. Uninterruptible services.
    - d. Partial occupancy before Substantial Completion.
    - e. Use of premises restrictions.
    - f. Provisions for future construction.
    - g. Seasonal variations.
    - h. Environmental control.
- D. Milestones: Include milestones indicated in the Contract Documents in schedule, including, but not limited to, the Notice to Proceed, Substantial Completion, and final completion.
- E. Upcoming Work Summary: Prepare summary report indicating activities scheduled to occur or commence prior to submittal of next schedule update. Summarize the following issues:
  - 1. Unresolved issues.
  - 2. Unanswered RFIs.
  - 3. Rejected or unreturned submittals.

4. Notations on returned submittals.

## 2.2 START-UP CONSTRUCTION SCHEDULE

- A. Bar-Chart Schedule: Submit start-up horizontal bar-chart-type construction schedule within seven days of date established for the Notice to Proceed .
- B. Preparation: Indicate each significant construction activity separately. Identify first workday of each week with a continuous vertical line. Outline significant construction activities for first 90 days of construction.

## 2.3 CONTRACTOR'S CONSTRUCTION SCHEDULE (CPM SCHEDULE)

- A. CPM Schedule Preparation: Prepare a list of all activities required to complete the Work. Using the start-up network diagram, prepare a skeleton network to identify probable critical paths.
  1. Activities: Indicate the estimated time duration, sequence requirements, and relationship of each activity in relation to other activities. Include estimated time frames for the following activities:
    - a. Preparation and processing of submittals.
    - b. Mobilization and demobilization.
    - c. Purchase of materials.
    - d. Delivery.
    - e. Fabrication.
    - f. Utility interruptions.
    - g. Installation.
    - h. Work by Owner that may affect or be affected by Contractor's activities.
    - i. Testing and commissioning.
    - j. Punch list and final completion.
    - k. Activities occurring following final completion.
  2. Critical Path Activities: Identify critical path activities, including those for interim completion dates. Scheduled start and completion dates shall be consistent with Contract milestone dates.
  3. Format: Mark the critical path. Locate the critical path near center of network; locate paths with most float near the edges.
- B. Contract Modifications: For each proposed contract modification and concurrent with its submission, prepare a time-impact analysis using a network fragment to demonstrate the effect of the proposed change on the overall project schedule.
- C. Initial Issue of Schedule: Identify critical activities. Prepare tabulated reports showing the following:
  1. Contractor or subcontractor and the Work or activity.
  2. Description of activity.
  3. Principal events of activity.

4. Immediate preceding and succeeding activities.
5. Early and late start dates.
6. Early and late finish dates.
7. Activity duration in workdays.

D. Schedule Updating: Submit at each weekly coordination meeting.

1. Identification of activities that have changed.
2. Changes in early and late start dates.
3. Changes in early and late finish dates.
4. Changes in activity durations in workdays.
5. Changes in the critical path.
6. Changes in total float or slack time.
7. Changes in the Contract Time.

Note: The Contractor may be allowed additional construction days due to inclement conditions ("rain days") only as such are appropriately documented and are in excess of the NOAA/National Weather Service average (previous 5 years) for the given month. A "rain day" is defined as more than a "trace" (0.10") of rain falling within a given 24 hour period. The Contractor shall provide documentation and formally request any "rain days" they feel are legitimately due. Documentation shall be submitted to the Project Manager, in writing, within ten (10) calendar days of the rain event.

## 2.4 REPORTS

- A. Field Condition Reports: Immediately on discovery of a difference between field conditions and the Contract Documents, prepare and submit a detailed report. Submit with a Request for Information. Include a detailed description of the differing conditions, together with recommendations for changing the Contract Documents.

## 2.5 SPECIAL REPORTS

- A. General: Submit special reports directly to Owner within one day of an occurrence. Distribute copies of report to parties affected by the occurrence.
- B. Reporting Unusual Events: When an event of an unusual and significant nature occurs at Project site, whether or not related directly to the Work, prepare and submit a special report. List chain of events, persons participating, response by Contractor's personnel, evaluation of results or effects, and similar pertinent information. Advise Owner in advance when these events are known or predictable.

## PART 3 - EXECUTION

Not Used

END OF SECTION

## **SECTION 01330 SUBMITTAL PROCEDURES**

### **PART 1 GENERAL**

#### **1.1 RELATED DOCUMENTS**

- A. Drawings and general provisions of the Contract, including General and Supplementary Conditions and Division 01 Specification Section, apply to this Section.

#### **1.2 SUMMARY**

- A. Section Includes:
  - 1. Submittal Procedure
  - 2. Submittal Schedule
  - 3. Shop Drawings
  - 4. Product Data
  - 5. Samples

#### **1.3 SUBMITTAL PROCEDURES**

- A. Number each submittal with Project Manual specification Section number and sequential number within each section. Number resubmittals with original number and an alphabetic suffix.
- B. Identify Project, Contractor, Subcontractor or supplier, pertinent Drawing sheet and detail numbers, and specification Section number, as appropriate.
- C. Submit all submittals simultaneously for each Produce or Specification Section. Where multiple Products function as an assembly, group submittals for all related Products into single submittal.
- D. Project Manager will not review incomplete submittals.
- E. Apply Contractor's stamp, signed or initialed certifying that:
  - 1. Submittal was reviewed.
  - 2. Products, field dimensions, and adjacent construction have been verified.
  - 3. Information has been coordinated with requirements for Work and Contract Documents.
- F. Schedule submittals to expedite the Project, and deliver to Project Manager. Coordinate submittal of related items.
- G. For each submittal, allow 10 days for Project Manager's review, excluding delivery time to and from Contractor. Identify variations from Contract Documents and Product or system limitations that may be detrimental to successful performance of completed Work.
- H. Revise and resubmit submittals when required; identify all changes made since previous submittals.

- I. Distribute copies of reviewed submittals to concerned parties and to Project Record Documents file. Instruct parties to promptly report any inability to comply with provisions.

#### 1.4 SUBMITTAL SCHEDULE

- A. Submit a submittal schedule showing all submittals proposed for project, including:
  1. Submittals for Review
  2. Closeout Submittals.
- B. Include for each submittal:
  1. Specification section number.
  2. Description of submittal.
  3. Type of submittal.
  4. Anticipated submittal date.
- C. Submit one (1) PDF copy.

#### 1.5 SHOP DRAWINGS

- A. Present information in clear and thorough manner.
- B. Identify details by reference to sheet and detail numbers or areas shown on Drawings.
- C. Reproductions of details contained in Contract Documents are not acceptable.
- D. Submit one (1) PDF copy. One PDF copy will be returned to Contractor for printing and distribution.

#### 1.6 PRODUCT DATA

- A. Mark each copy to identify applicable products, models, options, and other data.
- B. Supplement manufacturers' standard data to provide information unique to this Project.
- C. Submit 3 copies. Project Manager will return one copy to Contractor for printing and distribution.

#### 1.7 SAMPLES

- A. Submit samples to illustrate functional and aesthetic characteristics of Products, with integral parts and attachment of devices. Coordinate sample submittals for interfacing work.
- B. Where so indicated, submit samples of finishes from the full range of

manufacturers' standard colors, textures, and patterns for Project Manager's selection.

- C. Include identification for each sample, with full Project information.
- D. Project Manager will notify Contractor of approval or rejection of samples, or of selection of color, texture or pattern if full range is submitted.

END OF SECTION

## SECTION 01700 EXECUTION REQUIREMENTS

### PART 1 - GENERAL

#### 1.1 RELATED DOCUMENTS

- A. Drawings and general provisions of the Contract, including General and Supplementary Conditions and other Division 1 Specification Sections, apply to this Section.

#### 1.2 SUMMARY

- A. Section includes general administrative and procedural requirements governing execution of the Work including, but not limited to, the following:
  - 1. Environmental concerns.
  - 2. Installation of the Work.
  - 3. Cutting and patching.
  - 4. Progress cleaning.
  - 5. Starting and adjusting.
  - 6. Protection of installed construction.
  - 7. Correction of the Work.
- B. Related Sections:
  - 1. Division 1 Sections "Summary of the Work", "Project Record Documents", or "Closeout Procedures", if included in Project Manual, for submitting closeout documents and final cleaning.

#### 1.3 DEFINITIONS

- A. Cutting: Removal of in-place construction necessary to permit installation or performance of other work.
- B. Patching: Fitting and repair work required to restore construction to original conditions after installation of other work.

#### 1.4 INFORMATIONAL SUBMITTALS

- A. Cutting and Patching Plan: Submit plan describing procedures at least 10 days prior to the time cutting and patching will be performed. Include the following information:
  - 1. Extent: Describe reason for and extent of each occurrence of cutting and patching.
  - 2. Changes to In-Place Construction: Describe anticipated results. Include changes to structural elements and operating components as well as changes in building appearance and other significant visual elements.



3. Products: List products to be used for patching and firms or entities that will perform patching work.
4. Dates: Indicate when cutting and patching will be performed.
5. Utilities and Mechanical and Electrical Systems: List services and systems that cutting and patching procedures will disturb or affect. List services and systems that will be relocated and those that will be temporarily out of service. Indicate how long services and systems will be disrupted. Prior approval of Utility outages is required. Notify Owner of intent at least 72 hours in advance.

## 1.5 QUALITY ASSURANCE

- A. Cutting and Patching: Comply with requirements for and limitations on cutting and patching of construction elements.

## PART 2 - PRODUCTS

### 2.1 MATERIALS

- A. General: Comply with requirements specified in other Sections.
- B. In-Place Materials: Use materials for patching identical to in-place materials. For exposed surfaces, use materials that visually match in-place adjacent surfaces to the fullest extent possible.
  1. If identical materials are unavailable or cannot be used, use materials that, when installed, will provide a match acceptable to the Architect for the visual and functional performance of in-place materials.

## PART 3 - EXECUTION

### 3.1 EXAMINATION

- A. Existing Conditions: The existence and location of underground and other utilities and construction indicated as existing are not guaranteed. Before beginning work, investigate and verify the existence and location of underground utilities, mechanical and electrical systems, and other construction affecting the Work.
  1. Before construction, verify the location and invert elevation at points of connection of sanitary sewer, storm sewer, and water-service piping; underground electrical services, and other utilities.
  2. Furnish location data for work related to Project that must be performed by public utilities serving Project site.
- B. Examination and Acceptance of Conditions: Before proceeding with each component of the Work, examine substrates, areas, and conditions, with Installer or Applicator present

where indicated, for compliance with requirements for installation tolerances and other conditions affecting performance. Record observations.

1. Written Report: Where a written report listing conditions detrimental to performance of the Work is required by other Sections, include the following:
  - a. Description of the Work.
  - b. List of detrimental conditions, including substrates.
  - c. List of unacceptable installation tolerances.
  - d. Recommended corrections.
2. Verify compatibility with and suitability of substrates, including compatibility with existing finishes or primers.
3. Examine roughing-in for mechanical and electrical systems to verify actual locations of connections before equipment and fixture installation.
4. Examine walls, floors, and roofs for suitable conditions where products and systems are to be installed.
5. Proceed with installation only after unsatisfactory conditions have been corrected. Proceeding with the Work indicates acceptance of surfaces and conditions.

### 3.2 PREPARATION

- A. Field Measurements: Take field measurements as required to fit the Work properly. Recheck measurements before installing each product. Where portions of the Work are indicated to fit to other construction, verify dimensions of other construction by field measurements before fabrication. Coordinate fabrication schedule with construction progress to avoid delaying the Work.
- B. Space Requirements: Verify space requirements and dimensions of items shown diagrammatically on Drawings.
- C. Review of Contract Documents and Field Conditions: Immediately on discovery of the need for clarification of the Contract Documents caused by differing field conditions outside the control of the Contractor, submit a request for information to Architect according to requirements in Division 1 Section "Project Management and Coordination."
- D. Surface and Substrate Preparation: Comply with manufacturer's recommendations for preparation of substrates to receive subsequent work.

### 3.3 INSTALLATION

- A. General: Locate the Work and components of the Work accurately, in correct alignment and elevation, as indicated.
  1. Make vertical work plumb and make horizontal work level.
  2. Where space is limited, install components to maximize space available for maintenance and ease of removal for replacement.
  3. Conceal pipes, ducts, and wiring in finished areas, unless otherwise indicated.

4. Maintain minimum headroom clearance of 96 inches, but in no case shall the new piping be lower than the existing piping.
- B. Comply with manufacturer's written instructions and recommendations for installing products in applications indicated.
- C. Install products at the time and under conditions that will ensure the best possible results. Maintain conditions required for product performance until Substantial Completion.
- D. Conduct construction operations so no part of the Work is subjected to damaging operations or loading in excess of that expected during normal conditions of occupancy.
- E. Tools and Equipment: Do not use tools or equipment that produce harmful noise levels.
- F. Templates: Obtain and distribute to the parties involved templates for work specified to be factory prepared and field installed. Check Shop Drawings of other work to confirm that adequate provisions are made for locating and installing products to comply with indicated requirements.
- G. Attachment: Provide blocking and attachment plates and anchors and fasteners of adequate size and number to securely anchor each component in place, accurately located and aligned with other portions of the Work. Where size and type of attachments are not indicated, verify size and type required for load conditions.
  1. Mounting Heights: Where mounting heights are not indicated, mount components at heights directed by Architect.
  2. Allow for building movement, including thermal expansion and contraction.
  3. Coordinate installation of anchorages. Furnish setting drawings, templates, and directions for installing anchorages, including sleeves, concrete inserts, anchor bolts, and items with integral anchors, that are to be embedded in concrete or masonry. Deliver such items to Project site in time for installation.
- H. Joints: Make joints of uniform width. Where joint locations in exposed work are not indicated, arrange joints for the best visual effect. Fit exposed connections together to form hairline joints.
- I. Hazardous Materials: Use products, cleaners, and installation materials that are not considered hazardous, and meet environmental requirements.

### 3.4 CUTTING AND PATCHING

- A. Cutting and Patching, General: Employ skilled workers to perform cutting and patching. Proceed with cutting and patching at the earliest feasible time, and complete without delay.
  1. Cut in-place construction to provide for installation of other components or performance of other construction, and subsequently patch as required to restore surfaces to their original condition.
- B. Temporary Support: Provide temporary support of work to be cut.

- C. Protection: Protect in-place construction during cutting and patching to prevent damage. Provide protection from adverse weather conditions for portions of Project that might be exposed during cutting and patching operations.
- D. Adjacent Occupied Areas: Where interference with use of adjoining areas or interruption of free passage to adjoining areas is unavoidable, coordinate cutting and patching in accordance with requirements of Division 1 Section "Summary."
- E. Existing Utility Services and Mechanical/Electrical Systems: Where existing services/systems are required to be removed, relocated, or abandoned, bypass such services/systems before cutting to prevent interruption to occupied areas.
- F. Cutting: Cut in-place construction by sawing, drilling, breaking, chipping, grinding, and similar operations, including excavation, using methods least likely to damage elements retained or adjoining construction. If possible, review proposed procedures with original Installer; comply with original Installer's written recommendations.
  - 1. In general, use hand or small power tools designed for sawing and grinding, not hammering and chopping. Cut holes and slots neatly to minimum size required, and with minimum disturbance of adjacent surfaces. Temporarily cover openings when not in use.
  - 2. Finished Surfaces: Cut or drill from the exposed or finished side into concealed surfaces.
  - 3. [Concrete] [and] [Masonry]: Cut using a cutting machine, such as an abrasive saw or a diamond-core drill.
  - 4. Mechanical and Electrical Services: Cut off pipe or conduit in walls or partitions to be removed. Cap, valve, or plug and seal remaining portion of pipe or conduit to prevent entrance of moisture or other foreign matter after cutting.
  - 5. Proceed with patching after construction operations requiring cutting are complete.
- G. Patching: Patch construction by filling, repairing, refinishing, closing up, and similar operations following performance of other work. Patch with durable seams that are as invisible as practicable. Provide materials and comply with installation requirements specified in other Sections, where applicable.
  - 1. Inspection: Where feasible, test and inspect patched areas after completion to demonstrate physical integrity of installation.
  - 2. Exposed Finishes: Restore exposed finishes of patched areas and extend finish restoration into retained adjoining construction in a manner that will minimize evidence of patching and refinishing.
    - a. Clean piping, conduit, and similar features before applying paint or other finishing materials.
    - b. Restore damaged pipe covering to its original condition.
  - 3. Floors and Walls: Where walls or partitions that are removed extend one finished area into another, patch and repair floor and wall surfaces in the new space. Provide an even surface of uniform finish, color, texture, and appearance. Remove in-place floor and wall coverings and replace with new materials, if necessary, to achieve uniform color and appearance.

- a. Where patching occurs in a painted surface, prepare substrate and apply primer and intermediate paint coats appropriate for substrate over the patch, and apply final paint coat over entire unbroken surface containing the patch. Provide additional coats until patch blends with adjacent surfaces.
  4. Ceilings: Patch, repair, or rehang in-place ceilings as necessary to provide an even-plane surface of uniform appearance.
  5. Exterior Building Enclosure: Patch components in a manner that restores enclosure to a weathertight condition.
- H. Cleaning: Clean areas and spaces where cutting and patching are performed. Remove paint, mortar, oils, putty, and similar materials from adjacent finished surfaces.

### 3.5 PROGRESS CLEANING

- A. General: Clean Project site and work areas daily, including common areas. Enforce requirements strictly. Dispose of materials lawfully.
1. Comply with requirements in NFPA 241 for removal of combustible waste materials and debris.
  2. Do not hold waste materials more than seven days during normal weather or three days if the temperature is expected to rise above 80 deg F (27 deg C).
  3. Containerize hazardous and unsanitary waste materials separately from other waste. Mark containers appropriately and dispose of legally, according to regulations.
    - a. Utilize containers intended for holding waste materials of type to be stored.
  4. Coordinate progress cleaning for joint-use areas where more than one installer has worked.
- B. Site: Maintain Project site free of waste materials and debris.
- C. Work Areas: Clean areas where work is in progress to the level of cleanliness necessary for proper execution of the Work.
1. Remove liquid spills promptly.
  2. Where dust would impair proper execution of the Work, broom-clean or vacuum the entire work area, as appropriate.
- D. Installed Work: Keep installed work clean. Clean installed surfaces according to written instructions of manufacturer or fabricator of product installed, using only cleaning materials specifically recommended. If specific cleaning materials are not recommended, use cleaning materials that are not hazardous to health or property and that will not damage exposed surfaces.
- E. Exposed Surfaces in Finished Areas: Clean exposed surfaces and protect as necessary to ensure freedom from damage and deterioration at time of Substantial Completion.

- F. Waste Disposal: Do not bury or burn waste materials on-site. Do not wash waste materials down sewers or into waterways.
- G. During handling and installation, clean and protect construction in progress and adjoining materials already in place. Apply protective covering where required to ensure protection from damage or deterioration at Substantial Completion.
- H. Clean completed construction as frequently as necessary through the remainder of the construction period.

### 3.6 STARTING AND ADJUSTING

- A. Coordinate startup and adjusting of equipment and operating components with requirements in other Division 2 -16 Sections."
- B. Start equipment and operating components to confirm proper operation. Remove malfunctioning units, replace with new units, and retest.
- C. Adjust equipment for proper operation. Adjust operating components for proper operation without binding.
- D. Test each piece of equipment to verify proper operation. Test and adjust controls and safeties. Replace damaged and malfunctioning controls and equipment.
- E. Manufacturer's Field Service: Comply with qualification requirements in other Division 2-16 Sections.

### 3.7 PROTECTION OF INSTALLED CONSTRUCTION

- A. Provide final protection and maintain conditions that ensure installed Work is without damage or deterioration at time of Substantial Completion.
- B. Comply with manufacturer's written instructions for temperature and relative humidity.

### 3.8 CORRECTION OF THE WORK

- A. Repair or remove and replace defective construction. Restore damaged substrates and finishes.
  - 1. Repairing includes replacing defective parts, refinishing damaged surfaces, touching up with matching materials, and properly adjusting operating equipment.
- B. Restore permanent facilities used during construction to their specified condition.
- C. Remove and replace damaged surfaces that are exposed to view if surfaces cannot be repaired without visible evidence of repair.
- D. Repair components that do not operate properly. Remove and replace operating components that cannot be repaired.

- E. Remove and replace chipped, scratched, and broken glass or reflective surfaces.

### 3.9 ENVIRONMENTAL CONCERNS

- 1. Provide protection and conduct construction in ways that comply with environmental regulations and that minimize possible air, waterway, and subsoil contamination or pollution or other undesirable effects.

### 3.10 STORMWATER CONTROL AND DISCHARGE

- 1. Comply with City of Mobile and Alabama Department of Environmental Management requirements. Pay particular attention to Water Regulations and Allowable Discharges.
- 2. See City of Mobile Code, Chapter 17, Storm Water Management and Flood Control.
- 3. Obtain any necessary permits that may be required due to discharges.

END OF SECTION

## **SECTION 01710 CLOSEOUT PROCEDURES**

### **PART 1 - GENERAL**

#### **1.1 RELATED DOCUMENTS**

- A. Drawings and general provisions of the Contract, including General and Supplementary Conditions and other Division 01 Specification Sections, apply to this Section.

#### **1.2 SUMMARY**

- A. Section includes administrative and procedural requirements for contract closeout, including, but not limited to, the following:
  - 1. Substantial Completion procedures.
  - 2. Final completion procedures.
  - 3. Warranties.
  - 4. Final cleaning.
  - 5. Repair of the Work.

#### **1.3 ACTION SUBMITTALS**

- A. Product Data: For each type of cleaning agent.
- B. Contractor's List of Incomplete Items: Initial submittal at Substantial Completion.
- C. Certified List of Incomplete Items: Final submittal at final completion.

#### **1.4 CLOSEOUT SUBMITTALS**

- A. Certificates of Release: From authorities having jurisdiction.
- B. Certificate of Insurance: For continuing coverage.

#### **1.5 MAINTENANCE MATERIAL SUBMITTALS**

- A. Schedule of Maintenance Material Items: For maintenance material submittal items specified in other Sections.



## 1.6 SUBSTANTIAL COMPLETION PROCEDURES

- A. Contractor's List of Incomplete Items: Prepare and submit a list of items to be completed and corrected (Contractor's punch list), indicating the value of each item on the list and reasons why the Work is incomplete.
- B. Submittals Prior to Substantial Completion: Complete the following a minimum of 10 days prior to requesting inspection for determining date of Substantial Completion. List items below that are incomplete at time of request.
  - 1. Certificates of Release: Obtain and submit releases from authorities having jurisdiction permitting Owner unrestricted use of the Work and access to services and utilities. Include occupancy permits, operating certificates, and similar releases.
  - 2. Submit closeout submittals specified in other Division 01 Sections, including project record documents, operation and maintenance manuals, damage or settlement surveys, property surveys, and similar final record information.
  - 3. Submit closeout submittals specified in individual Sections, including specific warranties, workmanship bonds, maintenance service agreements, final certifications, and similar documents.
  - 4. Submit maintenance material submittals specified in individual Sections, including tools, spare parts, extra materials, and similar items, and deliver to location designated by Architect. Label with manufacturer's name and model number.
    - a. Schedule of Maintenance Material Items: Prepare and submit schedule of maintenance material submittal items, including name and quantity of each item and name and number of related Specification Section. Obtain Architect's signature for receipt of submittals.
  - 5. Submit testing, adjusting, and balancing records.
  - 6. Submit sustainable design submittals not previously submitted.
  - 7. Submit changeover information related to Owner's occupancy, use, operation, and maintenance.
- C. Procedures Prior to Substantial Completion: Complete the following a minimum of 10 days prior to requesting inspection for determining date of Substantial Completion. List items below that are incomplete at time of request.
  - 1. Advise Owner of pending insurance changeover requirements.
  - 2. Make final changeover of permanent locks and deliver keys to Owner. Advise Owner's personnel of changeover in security provisions.
  - 3. Complete startup and testing of systems and equipment.
  - 4. Perform preventive maintenance on equipment used prior to Substantial Completion.
  - 5. Instruct Owner's personnel in operation, adjustment, and maintenance of products, equipment, and systems.
  - 6. Advise Owner of changeover in utility services.
  - 7. Terminate and remove temporary facilities from Project site, along with mockups, construction tools, and similar elements.
  - 8. Complete final cleaning requirements.

9. Touch up paint and otherwise repair and restore marred exposed finishes to eliminate visual defects.

D. Inspection: Submit a written request for inspection to determine Substantial Completion a minimum of 10 days prior to date the Work will be completed and ready for final inspection and tests. On receipt of request, Architect will either proceed with inspection or notify Contractor of unfulfilled requirements. Architect will prepare the Certificate of Substantial Completion after inspection or will notify Contractor of items, either on Contractor's list or additional items identified by Architect, that must be completed or corrected before certificate will be issued.

1. Request reinspection when the Work identified in previous inspections as incomplete is completed or corrected.
2. Results of completed inspection will form the basis of requirements for final completion.

## 1.7 FINAL COMPLETION PROCEDURES

A. Submittals Prior to Final Completion: Before requesting final inspection for determining final completion, complete the following:

1. Certified List of Incomplete Items: Submit certified copy of Architect's Substantial Completion inspection list of items to be completed or corrected (punch list), endorsed and dated by Architect. Certified copy of the list shall state that each item has been completed or otherwise resolved for acceptance.
2. Certificate of Insurance: Submit evidence of final, continuing insurance coverage complying with insurance requirements.
3. Submit final completion photographic documentation.

B. Inspection: Submit a written request for final inspection to determine acceptance a minimum of 10 days prior to date the work will be completed and ready for final inspection and tests. On receipt of request, Architect will either proceed with inspection or notify Contractor of unfulfilled requirements. Architect will prepare a final Certificate for Payment after inspection or will notify Contractor of construction that must be completed or corrected before certificate will be issued.

1. Request reinspection when the Work identified in previous inspections as incomplete is completed or corrected.

## 1.8 LIST OF INCOMPLETE ITEMS (PUNCH LIST)

A. Organization of List: Include name and identification of each space and area affected by construction operations for incomplete items and items needing correction including, if necessary, areas disturbed by Contractor that are outside the limits of construction.

1. Organize items applying to each space by major element, including categories for ceiling, individual walls, floors, equipment, and building systems.
2. Include the following information at the top of each page:
  - a. Project name.
  - b. Date.

- c. Name of Architect.
  - d. Name of Contractor.
  - e. Page number.
3. Submit list of incomplete items in the following format:
- a. PDF electronic file. Architect will return annotated file.

## 1.9 SUBMITTAL OF PROJECT WARRANTIES

- A. Time of Submittal: Submit written warranties on request of Architect for designated portions of the Work where warranties are indicated to commence on dates other than date of Substantial Completion, or when delay in submittal of warranties might limit Owner's rights under warranty.
- B. Organize warranty documents into an orderly sequence based on the table of contents of Project Manual.
- C. Warranty Electronic File: Provide warranties and bonds in PDF format. Assemble complete warranty and bond submittal package into a single electronic PDF file with bookmarks enabling navigation to each item. Provide bookmarked table of contents at beginning of document.
- D. Warranties in Paper Form:
  1. Bind warranties and bonds in heavy-duty, three-ring, vinyl-covered, loose-leaf binders, thickness as necessary to accommodate contents, and sized to receive 8-1/2-by-11-inch paper.
  2. Provide heavy paper dividers with plastic-covered tabs for each separate warranty. Mark tab to identify the product or installation. Provide a typed description of the product or installation, including the name of the product and the name, address, and telephone number of Installer.
  3. Identify each binder on the front and spine with the typed or printed title "WARRANTIES," Project name, and name of Contractor.
- E. Provide additional copies of each warranty to include in operation and maintenance manuals.

## PART 2 - PRODUCTS

### 2.1 MATERIALS

- A. Cleaning Agents: Use cleaning materials and agents recommended by manufacturer or fabricator of the surface to be cleaned. Do not use cleaning agents that are potentially hazardous to health or property or that might damage finished surfaces.

1. Use cleaning products that comply with Green Seal's GS-37, or if GS-37 is not applicable, use products that comply with the California Code of Regulations maximum allowable VOC levels.

## PART 3 - EXECUTION

### 3.1 FINAL CLEANING

- A. General: Perform final cleaning. Conduct cleaning and waste-removal operations to comply with local laws and ordinances and Federal and local environmental and antipollution regulations.
- B. Cleaning: Employ experienced workers or professional cleaners for final cleaning. Clean each surface or unit to condition expected in an average commercial building cleaning and maintenance program. Comply with manufacturer's written instructions.
  1. Complete the following cleaning operations before requesting inspection for certification of Substantial Completion for entire Project or for a designated portion of Project:
    - a. Clean Project site, and grounds, in areas disturbed by construction and delivery activities, of rubbish, waste material, litter, and other foreign substances.
    - b. Sweep paved areas broom clean. Remove petrochemical spills, stains, and other foreign deposits.
    - c. Remove tools, construction equipment, machinery, and surplus material from Project site.
    - d. Clean interior hard-surfaced finishes to a dirt-free condition, free of stains, films, and similar foreign substances. Avoid disturbing natural weathering of exterior surfaces. Restore reflective surfaces to their original condition.
    - e. Remove debris and surface dust from limited access spaces, including roofs, plenums, shafts, trenches, equipment vaults, manholes, attics, and similar spaces.
    - f. Sweep concrete floors broom clean in unoccupied spaces.
    - g. Clean transparent materials, including mirrors and glass in doors and windows. Remove glazing compounds and other noticeable, vision-obscuring materials. Polish mirrors and glass, taking care not to scratch surfaces.
    - h. Remove labels that are not permanent.
    - i. Wipe surfaces of mechanical and electrical equipment, and similar equipment. Remove excess lubrication, paint and mortar droppings, and other foreign substances.
    - j. Clean plumbing fixtures to a sanitary condition, free of stains, including stains resulting from water exposure.
    - k. Replace disposable air filters and clean permanent air filters. Clean exposed surfaces of diffusers, registers, and grills.
    - l. Clean ducts, blowers, and coils if units were operated without filters during construction or that display contamination with particulate matter on inspection.

- m. Clean light fixtures, lamps, globes, and reflectors to function with full efficiency.
- n. Leave Project clean and ready for occupancy.

### 3.2 REPAIR OF THE WORK

- A. Complete repair and restoration operations before requesting inspection for determination of Substantial Completion.
- B. Repair, or remove and replace, defective construction. Repairing includes replacing defective parts, refinishing damaged surfaces, touching up with matching materials, and properly adjusting operating equipment. Where damaged or worn items cannot be repaired or restored, provide replacements. Remove and replace operating components that cannot be repaired. Restore damaged construction and permanent facilities used during construction to specified condition.
  - 1. Remove and replace chipped, scratched, and broken glass, reflective surfaces, and other damaged transparent materials.
  - 2. Touch up and otherwise repair and restore marred or exposed finishes and surfaces. Replace finishes and surfaces that already show evidence of repair or restoration.
    - a. Do not paint over "UL" and other required labels and identification, including mechanical and electrical nameplates. Remove paint applied to required labels and identification.
  - 3. Replace parts subject to operating conditions during construction that may impede operation or reduce longevity.
  - 4. Replace burned-out bulbs, bulbs noticeably dimmed by hours of use, and defective and noisy starters in fluorescent and mercury vapor fixtures to comply with requirements for new fixtures.

END OF SECTION

## **SECTION 01731 CUTTING AND PATCHING**

### **PART 1 - GENERAL**

#### **1.1 SUMMARY**

- A. This section includes procedural requirements for cutting and patching.
- B. Definition: Cutting and patching includes cutting into existing construction to provide for the installation or performance of other work and subsequent fitting and repair required to restore surfaces to their original condition.
- C. Operational Limitations: Do not cut and patch operating elements, safety related systems, or related components in a manner that would result in reducing their capacity to perform as intended. Do not cut and patch operating elements, safety related systems or related components in a manner that would result in increased maintenance or decreased operational life or safety.

### **PART 2 - PRODUCTS**

#### **2.1 MATERIALS**

- A. Use materials identical to existing materials to the maximum extent available.
- B. For exposed surfaces, use materials that visually match existing adjacent surfaces to the fullest extent possible.
- C. Use materials whose installed performance will equal or surpass that of existing materials.

### **PART 3 - EXECUTION**

#### **3.1 INSPECTION**

- A. Before cutting, examine surfaces to be cut and patched and conditions under which cutting and patching is to be performed. If unsafe or unsatisfactory conditions are encountered, take corrective action before proceeding.
- B. Before proceeding with cutting and patching involving two or more trades, meet at the Project site with the entities providing or affected by the cutting and patching. Review areas of potential interference and conflict. Coordinate procedures and resolve potential conflicts before proceeding.

### 3.2 PREPARATION

- A. Provide temporary support of work to be cut.
- B. Protect existing conditions during cutting and patching to prevent damage.
- C. Bypass in-service existing pipe, conduit, or ductwork scheduled to be removed or relocated before cutting.

### 3.3 PERFORMANCE

- A. Employ skilled workmen to perform cutting and patching. Proceed with cutting and patching at the earliest feasible time and complete without delay.
- B. Cutting: Cut existing construction using methods least likely to damage elements retained and adjoining construction. Where possible, review proposed procedures with the original installer and comply with the original installer's recommendations.
  - 1. In general, use hand or small power tools designed for sawing or grinding, not for hammering and chopping.
  - 2. Cut through concrete and masonry using a cutting machine, such as a Carborundum saw or a diamond-core drill.
- C. Patching: Patch with durable seams that are as invisible as possible. Comply with specified tolerances.
  - 1. Where feasible, inspect and test patched areas to demonstrate integrity of the installation.
  - 2. Restore exposed finishes of patched areas and extend finish restoration into adjoining construction in a manner that will eliminate evidence of patching and refinishing.

### 3.4 CLEANING

- A. Clean areas and spaces where cutting and patching are performed. Completely remove paint, mortar, oils, putty, and similar items.

END OF SECTION

**SECTION 017839  
PROJECT RECORD DOCUMENTS**

**PART 1 - GENERAL**

**1.1 SUMMARY**

- A. This Section includes administrative and procedural requirements for Project Record Documents, including the following:
  - 1. Record Drawings.
  - 2. Record Specifications.
  - 3. Record Product Data.
- B. See Divisions 01 through 16 Sections for specific requirements for Project Record Documents of the Work in those Sections.

**1.2 SUBMITTALS**

- A. Record Drawings: Comply with the following:
  - 1. Number of Copies: Submit copies of Record Drawings as follows:
    - a. Final Submittal: Submit one set of marked-up Record Prints, showing all dimensional locations, materials changes, any changes via addendum or change order. Pay particular attention to noting underground utilities.
- B. Record Specifications: Submit one copy of Project's Specifications, including addenda and contract modifications.
- C. Record Product Data: Submit two copies of each Product Data submittal.
- D. Submit PDF's of Record Drawings, Record Specifications, Record Change Orders, Requests for Proposal, Documentation of use of Allowances, Product and Contractor's Warrantees, Product Test Reports, Final Surveys, Record Product Data, etc on 2 discs.

**PART 2 - PRODUCTS**

**2.1 RECORD DRAWINGS**

- A. Record Prints: Maintain one set of blue- or black-line white prints of the Contract Drawings and Shop Drawings.
  - 1. Preparation: Mark Record Prints to show the actual installation where installation varies from that shown originally. Require individual or entity who obtained record data, whether individual or entity is Installer, subcontractor, or similar entity, to prepare the marked-up Record Prints.



- a. Give particular attention to information on concealed elements that would be difficult to identify or measure and record later.
    - b. Record data as soon as possible after obtaining it. Record and check the markup before enclosing concealed installations.
  2. Mark the Contract Drawings or Shop Drawings, whichever is most capable of showing actual physical conditions, completely and accurately. If Shop Drawings are marked, show cross-reference on the Contract Drawings.
  3. Mark record sets with erasable, red-colored pencil. Use other colors to distinguish between changes for different categories of the Work at same location.
  4. Note Construction Change Directive numbers, alternate numbers, Change Order numbers, and similar identification, where applicable.
- B. Format: Identify and date each Record Drawing; include the designation "PROJECT RECORD DRAWING" in a prominent location.
1. Record Prints: Organize Record Prints and newly prepared Record Drawings into manageable sets. Bind each set with durable paper cover sheets. Include identification on cover sheets.
  2. Identification: As follows:
    - a. Project name.
    - b. Date.
    - c. Designation "PROJECT RECORD DRAWINGS."
    - d. Name of Architect and Engineer.
    - e. Name of Contractor.

## 2.2 RECORD SPECIFICATIONS

- A. Preparation: Mark Specifications to indicate the actual product installation where installation varies from that indicated in Specifications, addenda, and contract modifications.
1. Give particular attention to information on concealed products and installations that cannot be readily identified and recorded later.
  2. Mark copy with the proprietary name and model number of products, materials, and equipment furnished, including substitutions and product options selected.
  3. Record the name of manufacturer, supplier, Installer, and other information necessary to provide a record of selections made.
  4. Note related Change Orders, Record Product Data, and Record Drawings where applicable.

## 2.3 RECORD PRODUCT DATA

- A. Preparation: Mark Product Data to indicate the actual product installation where installation varies substantially from that indicated in Product Data submittal.

1. Give particular attention to information on concealed products and installations that cannot be readily identified and recorded later.
2. Include significant changes in the product delivered to Project site and changes in manufacturer's written instructions for installation.
3. Note related Change Orders, Record Specifications, and Record Drawings where applicable.

#### 2.4 MISCELLANEOUS RECORD SUBMITTALS

- A. Assemble miscellaneous records required by other Specification Sections for miscellaneous record keeping and submittal in connection with actual performance of the Work. Bind or file miscellaneous records and identify each, ready for continued use and reference.
- B. Completed Test Reports.

### PART 3 - EXECUTION

#### 3.1 RECORDING AND MAINTENANCE

- A. Recording: Maintain one copy of each submittal during the construction period for Project Record Document purposes. Post changes and modifications to Project Record Documents as they occur; do not wait until the end of Project.
- B. Maintenance of Record Documents and Samples: Store Record Documents and Samples in the field office apart from the Contract Documents used for construction. Do not use Project Record Documents for construction purposes. Maintain Record Documents in good order and in a clean, dry, legible condition, protected from deterioration and loss. Provide access to Project Record Documents for Architect's reference during normal working hours.

END OF SECTION





# CITY OF MOBILE, ALABAMA

## CONSTRUCTION PLANS FOR PINEHILL RECYCLING CENTER - NEW MODULAR BUILDING PROJECT NO: PW-062-24 308 PINEHILL DRIVE MOBILE, ALABAMA 36606 DISTRICT 5: JOEL DAVES

| CITY OF MOBILE ELECTED OFFICIALS |   |
|----------------------------------|---|
| MAYOR: HONORABLE SANDY STIMPSON  |   |
| DISTRICT 1: CORY PENN            |  |
| DISTRICT 2: WILLIAM CARROLL      |   |
| DISTRICT 3: C. J. SMALL          |   |
| DISTRICT 4: BEN REYNOLDS         |   |
| DISTRICT 5: JOEL DAVES           |   |
| DISTRICT 6: JOSH WOODS           |   |
| DISTRICT 7: GINA GREGORY         |   |

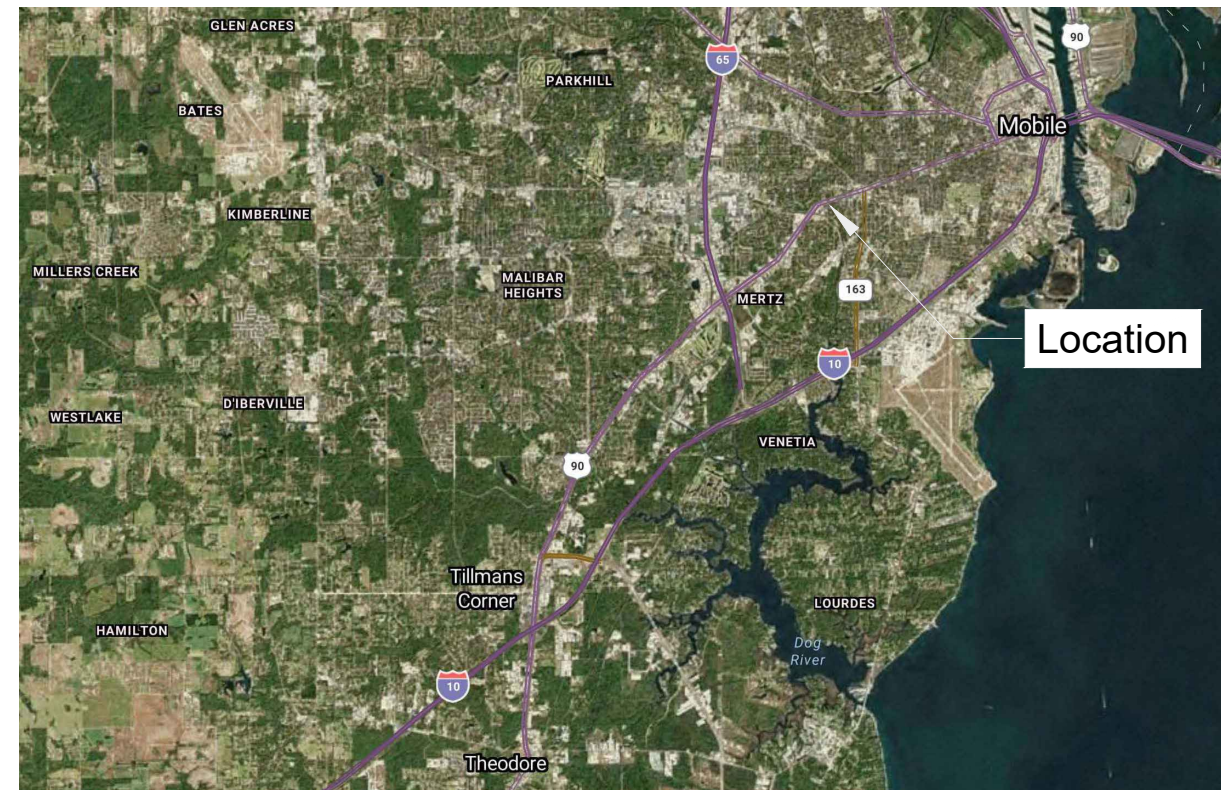
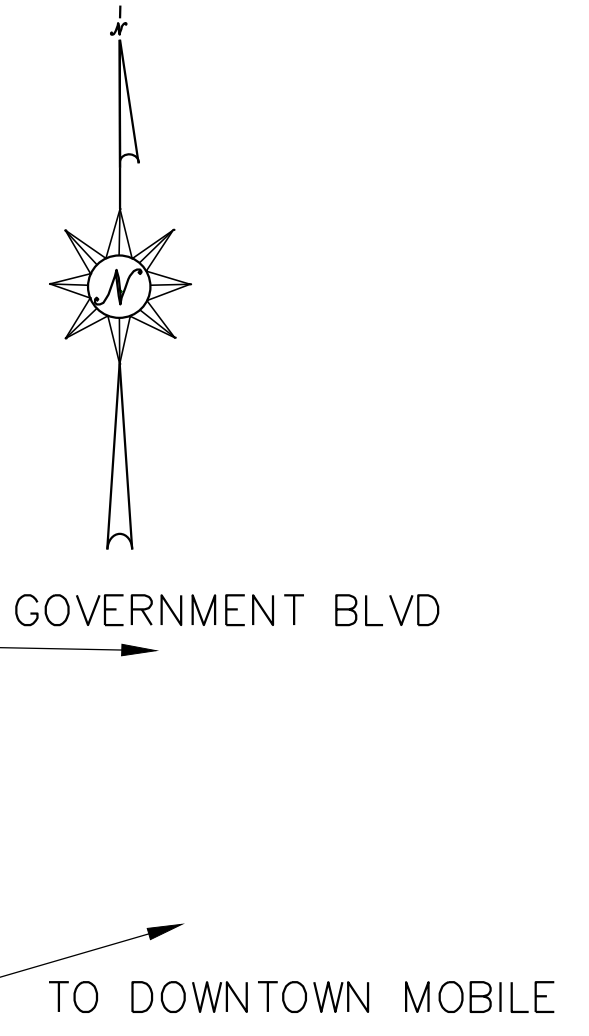
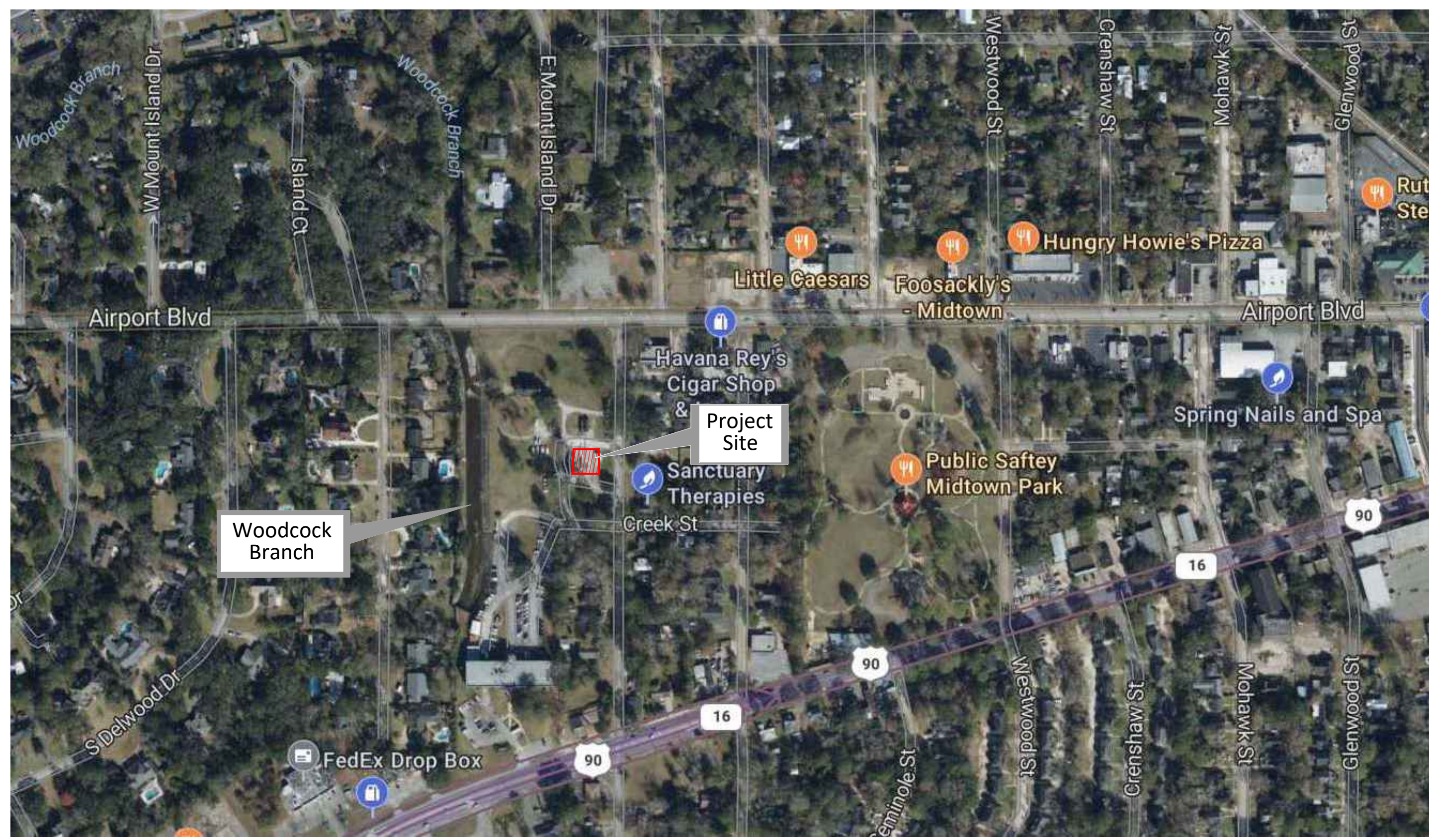

VICINITY MAP

AREA MAP  
NTS

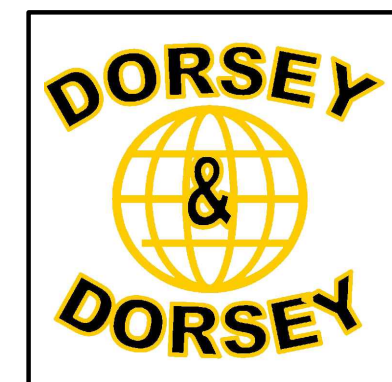
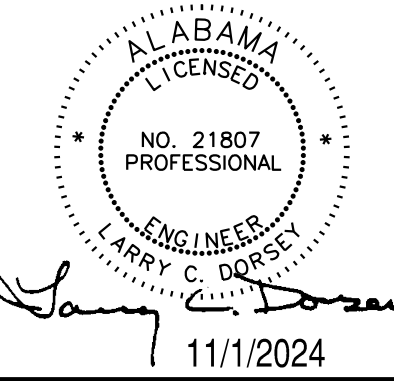

6051 AIRPORT BLVD, STE B3  
MOBILE, AL 36608  
p251.605.2023

PREPARED BY: DORSEY & DORSEY ENGINEERING, INC.  
ENGINEER: LARRY C. DORSEY, PE  
LICENSE NO.: ALABAMA 21807  
DATE: August 17, 2023



**PROJECT SPECIFIC ENVIRONMENTAL CONTROLS**

**NOTES:**

1. The contractor shall be fully responsible for the protection of water quality at all times during construction. the contractor shall size, install, and maintain adequate controls for the site. Refer to the ALABAMA HANDBOOK FOR EROSION CONTROL, SEDIMENT CONTROL and STORMWATER MANAGEMENT ON CONSTRUCTION SITES AND URBAN AREAS, LATEST EDITION.
2. Contractor shall contact the CITY ENGINEERING DEPARTMENT via email at [land\\_disturbance@cityofmobile.org](mailto:land_disturbance@cityofmobile.org) at least 24 hours prior to beginning any work on this site, to schedule an initial on-site BMP inspection with the appropriate city engineering inspector. Failure to contact the CITY ENGINEERING DEPARTMENT prior to beginning any work is a violation of the STORM WATER MANAGEMENT AND FLOOD CONTROL ORDINANCE and may invoke enforcement action in the form of a municipal offense ticket.
3. At a minimum, silt fence and/or wattles must be placed along the outer edges of the active site to protect any direct or indirect sedimentation flows onto adjacent properties or into the surrounding streets and inlets.
4. A system of wattles or other devices shall be used to protect any area or drop inlets on the site.
5. All controls must remain in place until a stabilized surface is established and protected with proper ground cover. Any disturbed area(s) may not remain denuded longer than 10 days.
6. The contractor is responsible for daily inspections and continued maintenance of all erosion control elements.
7. The controls are only shown as a minimum guide for initial locations. This does not minimize the requirements that be maybe necessary with the different construction activities.
8. See Sheet C502 for supplemental BMP requirements that can be used if necessary.

DESCRIPTION:  
ALL BLK 1 GOVERNMENT STREET HGTS CONSISTING OF LOTS 1 THRU 10 BLK 1 GOVERNMENT ST HGTS DBK 124/219 AND 15 FT ALLEYWAY SHOWN IN BLK 1.

ADDRESS: 308 PINEHILL DRIVE  
OWNER: CITY OF MOBILE  
PARCEL NO. R022909291001088.000  
AREA DISTURBED: 0.03 ACRES (NEW CONCRETE PAD ONLY)

**NOTES:**

1. RECYCLE FACILITIES ARE EXISTING, CONSTRUCTED IN 2017. THIS PLAN REFLECTS THE AS-BUILT CONDITIONS ONLY. NO ADDITIONAL IMPROVEMENTS ARE PROPOSED.
2. CONTOURS SHOWN WERE TAKEN FROM THE CITY OF MOBILE GIS MAP.
3. ELEVATIONS SHOWN ARE RELATIVE TO AN ASSUMED ELEVATION AND NOT SURVEY ELEVATIONS.

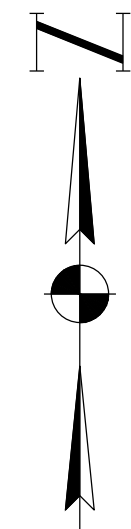
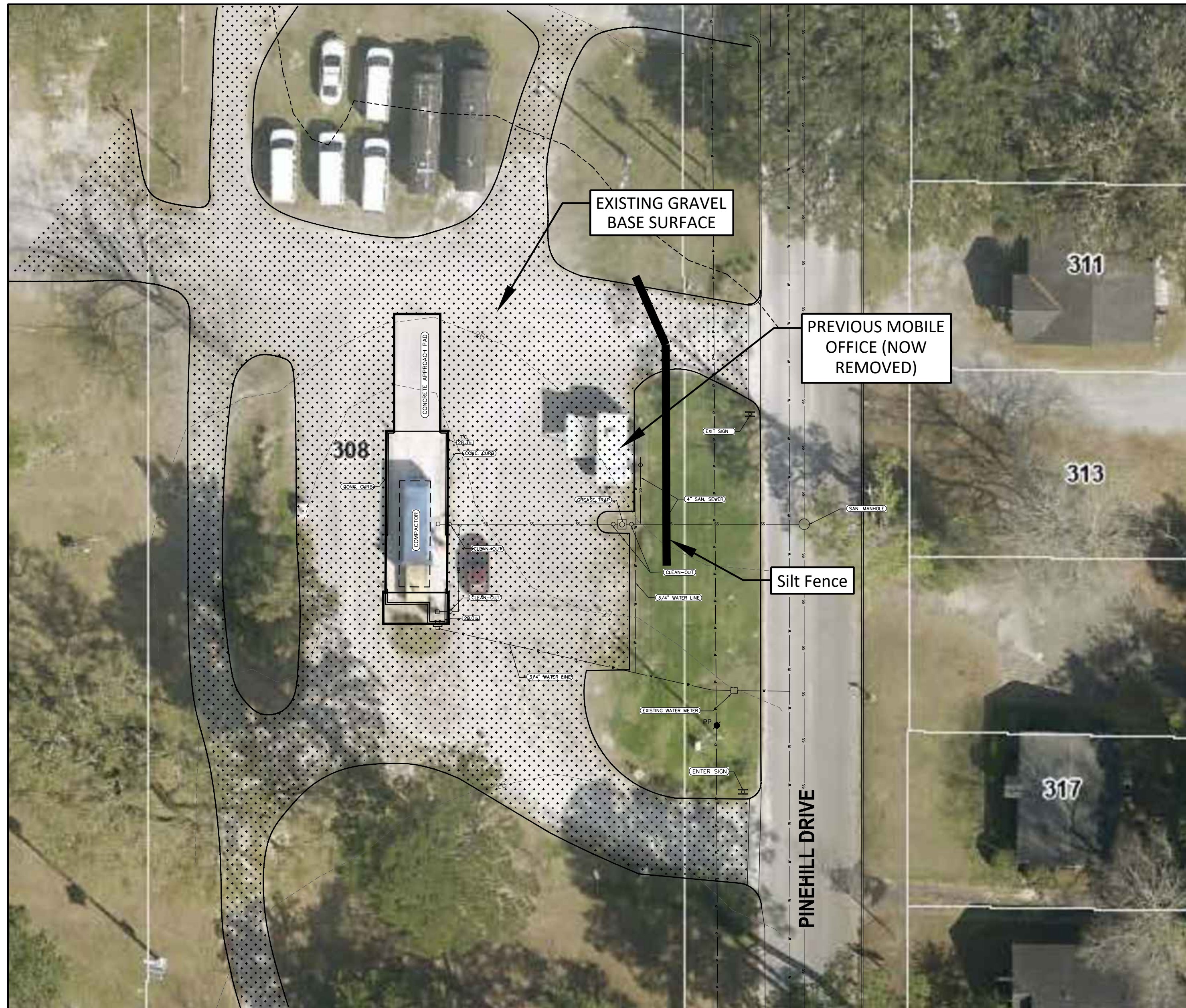

**Existing Site**

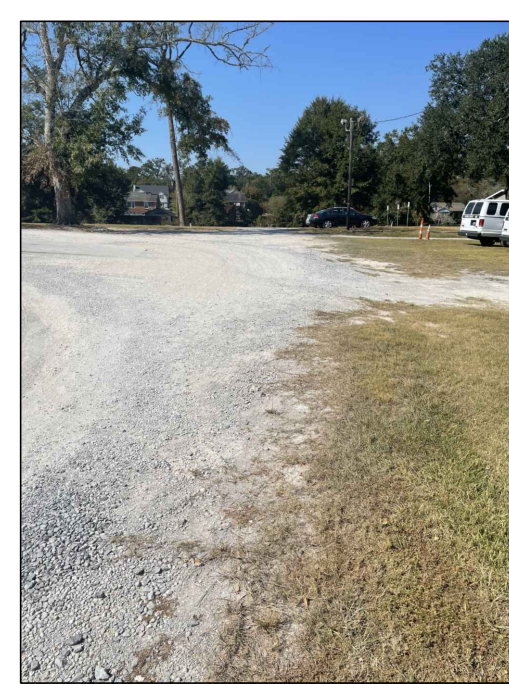
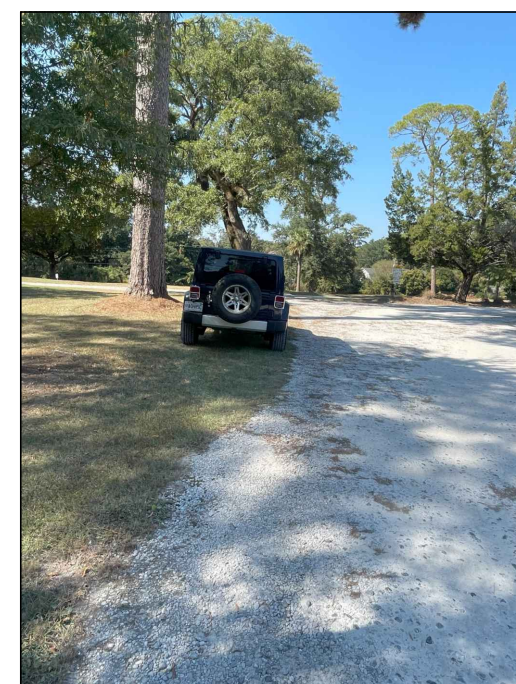

**SPECIFICATION NOTES:**

Unless indicated otherwise, all site work shall meet the latest standards (with the exception to the payment clauses) of the Alabama Department of Transportation (ALDOT) latest edition. Below are the primary standards, but not necessarily all needed to build this site as presented:

- Clearing and Grubbing: Section 201
- Removals: Section 205
- Earthwork: Section 210 (A-4 or better)
- Density: Section 306.03(b)
- Topsoil: Section 650
- Ground Preparation: Section 652
- Mulching: Section 656
- Temporary Soil Erosion: Section 665
- Construction Safety Fence: Section 674
- Materials: Division 800

CITY PROJECT NO: PW-062-24

**PINEHILL RECYCLING CENTER  
NEW MODULAR BUILDING**

308 PINEHILL DRIVE  
CITY OF MOBILE, ALABAMA

SHEET DESCRIPTION & NUMBER:

EXISTING SITE/ &  
BEST MANAGEMENT  
PLAN

C101

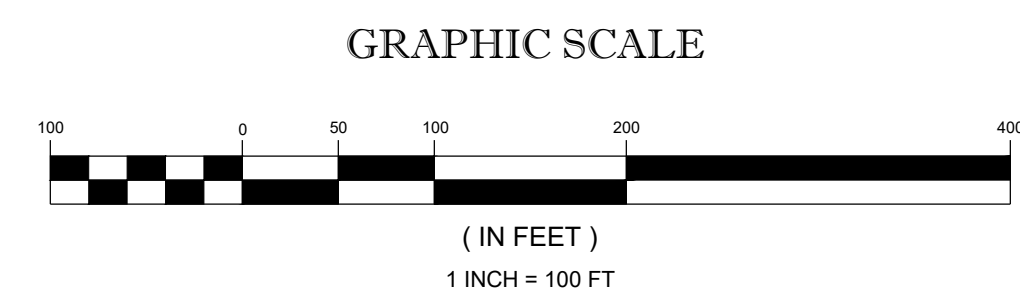

|  |                               |
|--|-------------------------------|
| DORSEY JOB NUMBER:<br>MOB-2024-03              | DESIGNED BY:<br>L. DORSEY, PE |
| ISSUE DATE:<br>11/1/2024                       | DRAWN BY:<br>DORSEY           |
| CAD FILE NAME:<br>C101-PinehillRecyclingCenter | CHECKED BY:<br>S. DORSEY      |
| REVISIONS/ISSUES:                              | DATE:                         |
|  |                               |
|  |                               |

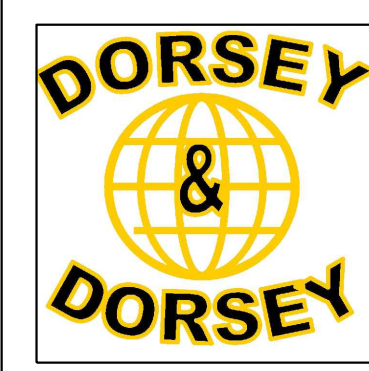
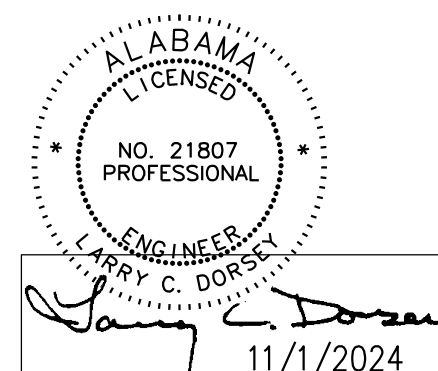

Integrity  
Quality  
Excellence

6051 AIRPORT BLVD., STE B3  
MOBILE, ALABAMA 36608  
p251.605.2023





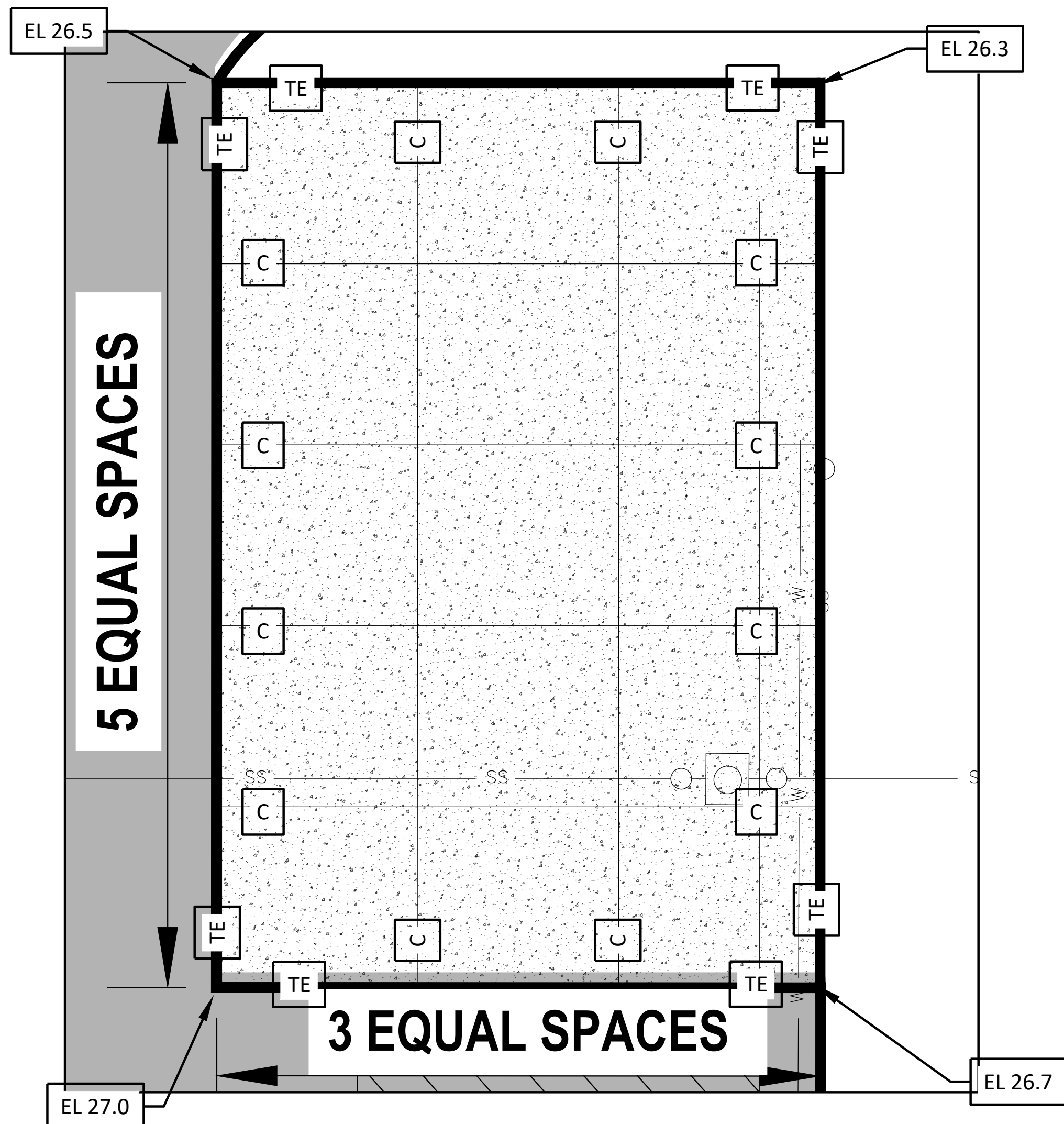

### Joint Layout Plan

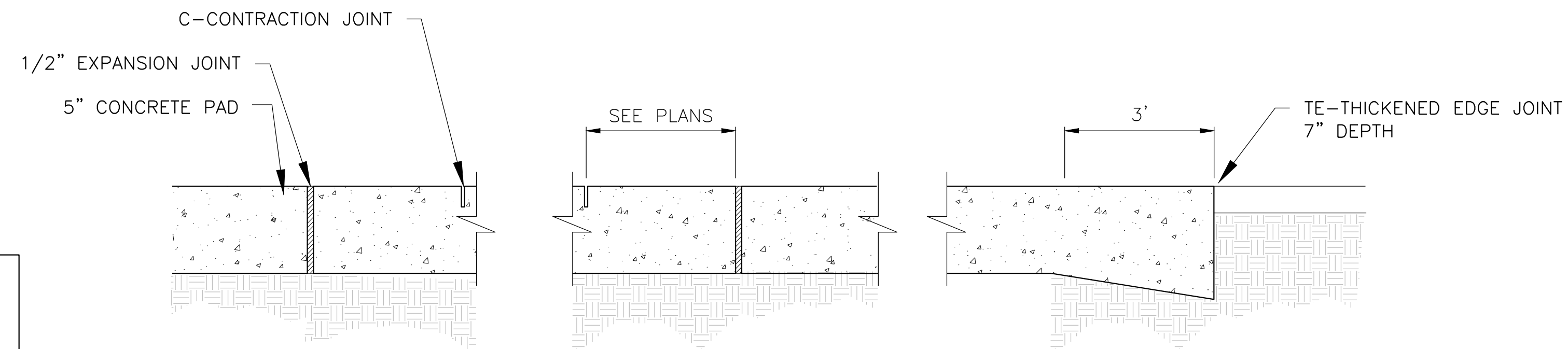

C CONTRACTION JOINT  
TE THICKENED EDGE CONSTRUCTION JOINT

**PROJECT NOTES:**

1. All concrete for the slabs (entrance and building) shall be fiber reinforced and a minimum 650 PSI flex.
2. The building slab shall be 5" thick with 7" thickened edges (TE).

### CONCRETE JOINTS

NOT TO SCALE

NOTE: EXPANSION JOINTS ARE REQUIRED AT LOCATIONS FOR RETURNS, AROUND STRUCTURES AND WHERE THE PAVEMENT ABUTS ANY WALL OR FLOOR.

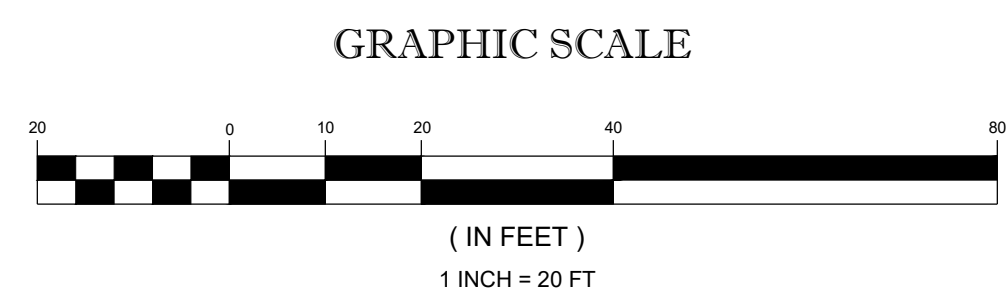

|  |                               |
|--|-------------------------------|
| DORSEY JOB NUMBER:<br>MOB-2024-03              | DESIGNED BY:<br>L. DORSEY, PE |
| ISSUE DATE:<br>11/1/2024                       | DRAWN BY:<br>DORSEY           |
| CAD FILE NAME:<br>C301-PinehillRecyclingCenter | CHECKED BY:<br>S. DORSEY      |
| REVISIONS/ISSUES:                              | DATE:                         |
|  |                               |

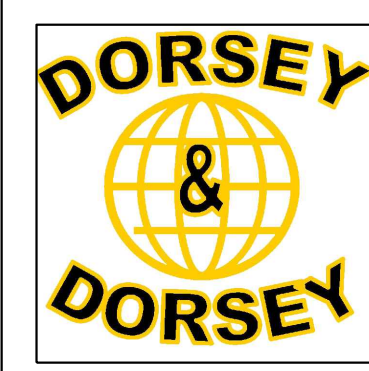
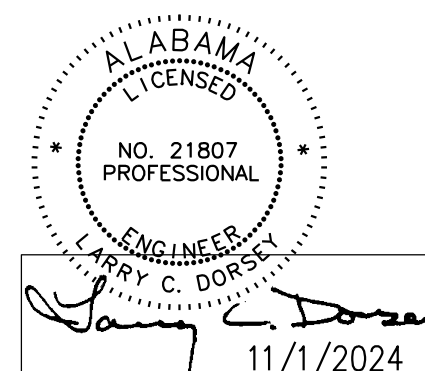

Integrity  
 Quality  
 Excellence  
  
 6051 AIRPORT BLVD., STE B3  
 MOBILE, ALABAMA 36608  
 p251.605.2023

**CITY PROJECT NO: PW-062-24**  
**PINEHILL RECYCLING CENTER**  
**NEW MODULAR BUILDING**

308 PINEHILL DRIVE  
 CITY OF MOBILE, ALABAMA

SHEET DESCRIPTION & NUMBER:  
 CONCRETE PAD  
 C301



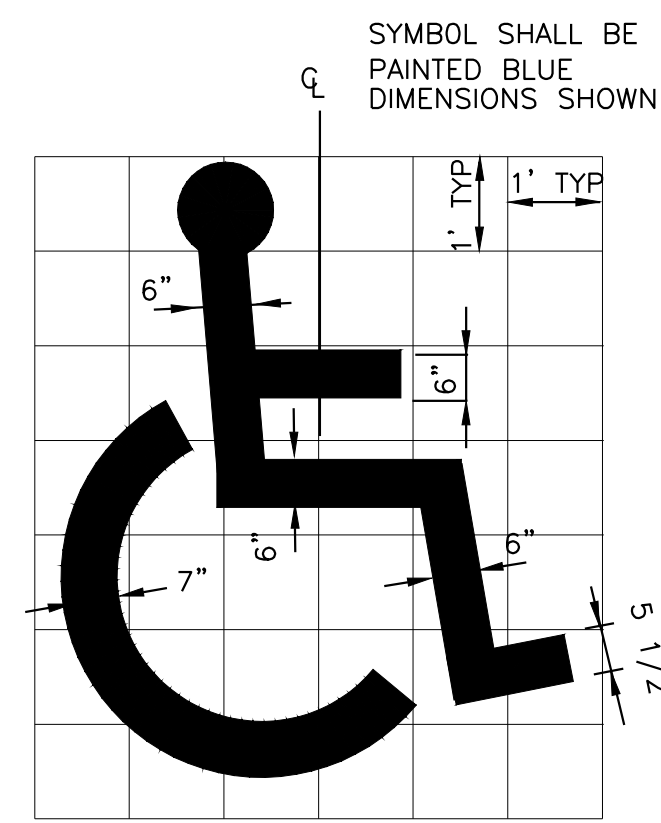

**HANDICAP SYMBOL PAINT DETAIL**

NOT TO SCALE

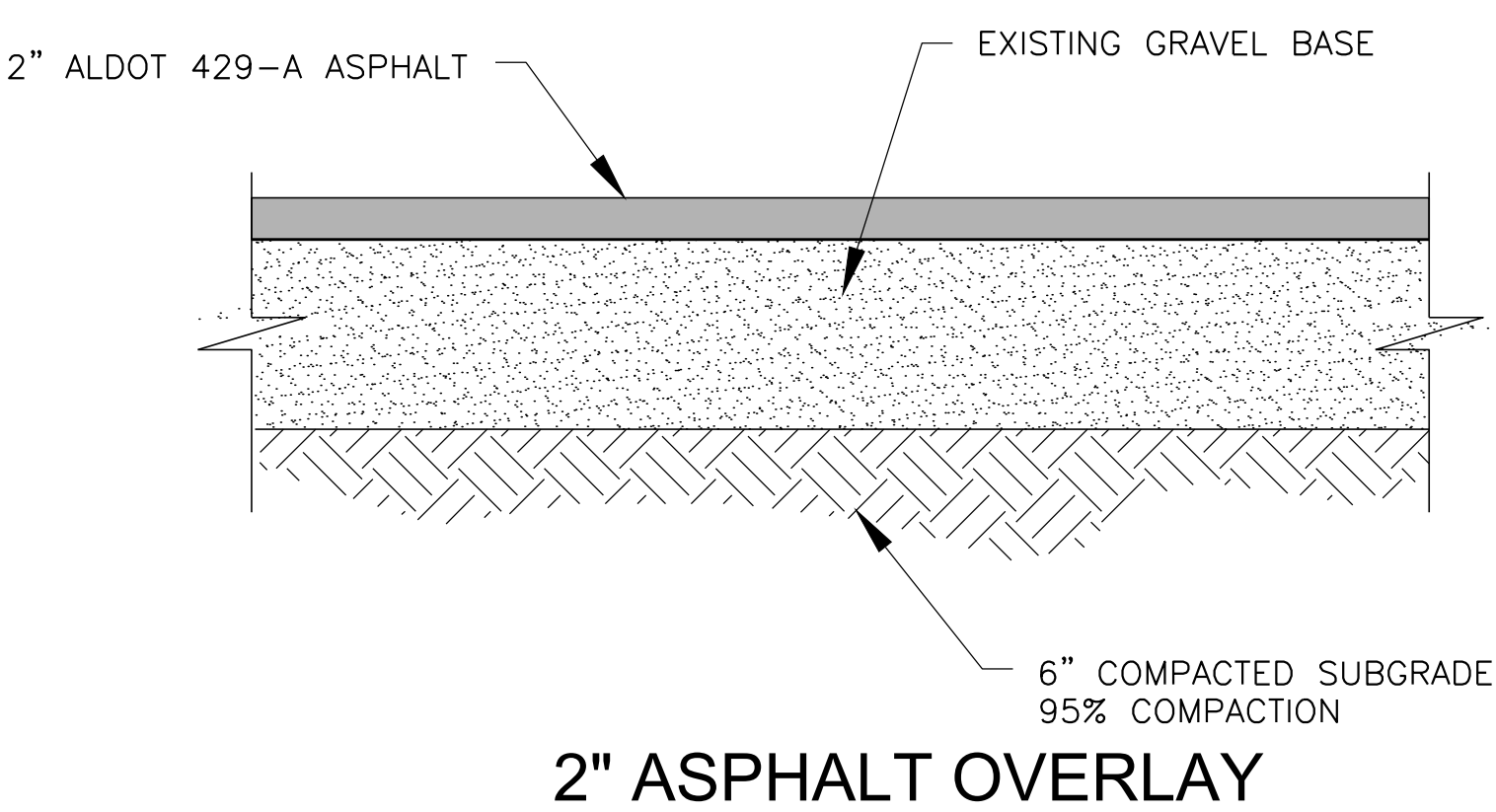

**2" ASPHALT OVERLAY**

NOT TO SCALE

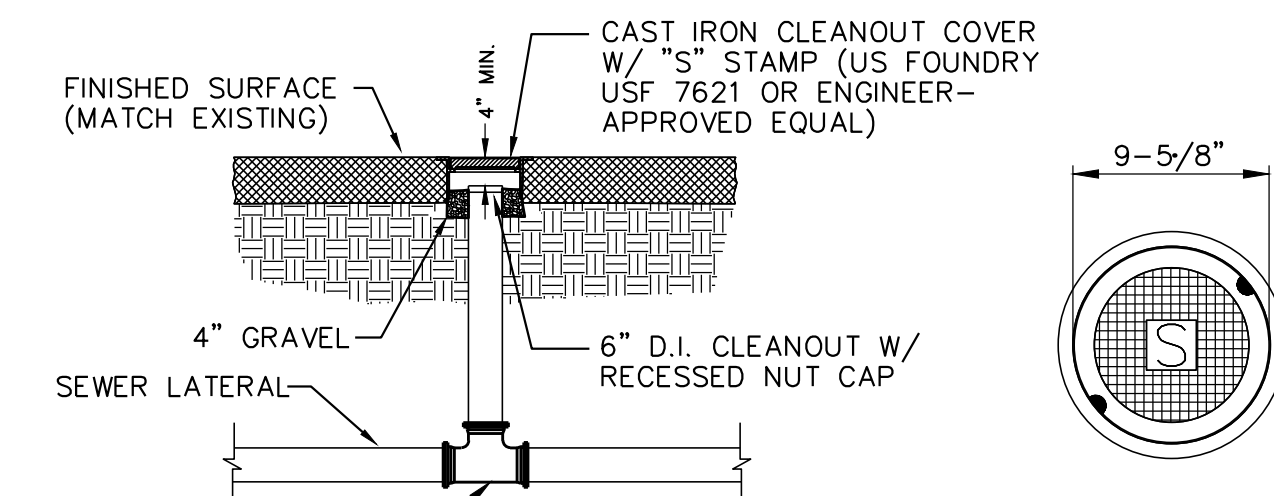

**CLEANOUT COVER DETAIL**

6" PVC DOUBLE-SWEEP TEE, OR SINGLE-SWEEP COMBINATION WYE AND 1/8" BEND AS APPROPRIATE

**TRAFFIC BEARING SURFACE CLEANOUT DETAIL**

NOT TO SCALE

**NOTES:**

1. A CLEANOUT SHALL BE PLACED WITHIN 2' TO 5' OF BUILDING OR AS APPROVED BY THE ENGINEER. IN ACCORDANCE WITH CITY OF MOBILE PLUMBING CODES, CLEANOUTS PLACED AT THE BUILDINGS SHALL HAVE DOUBLE-SWEEP TEES.
2. A CAST IRON CLEANOUT COVER AS SHOWN IN DETAIL ABOVE SHALL BE INSTALLED IN TRAFFIC-BEARING SURFACES.

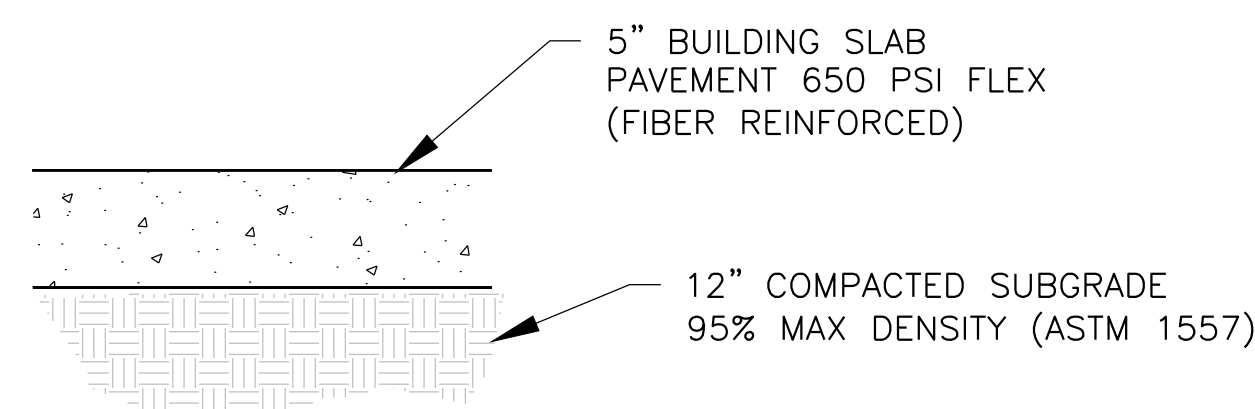

**CONCRETE PAVEMENT SLABS**

NOT TO SCALE

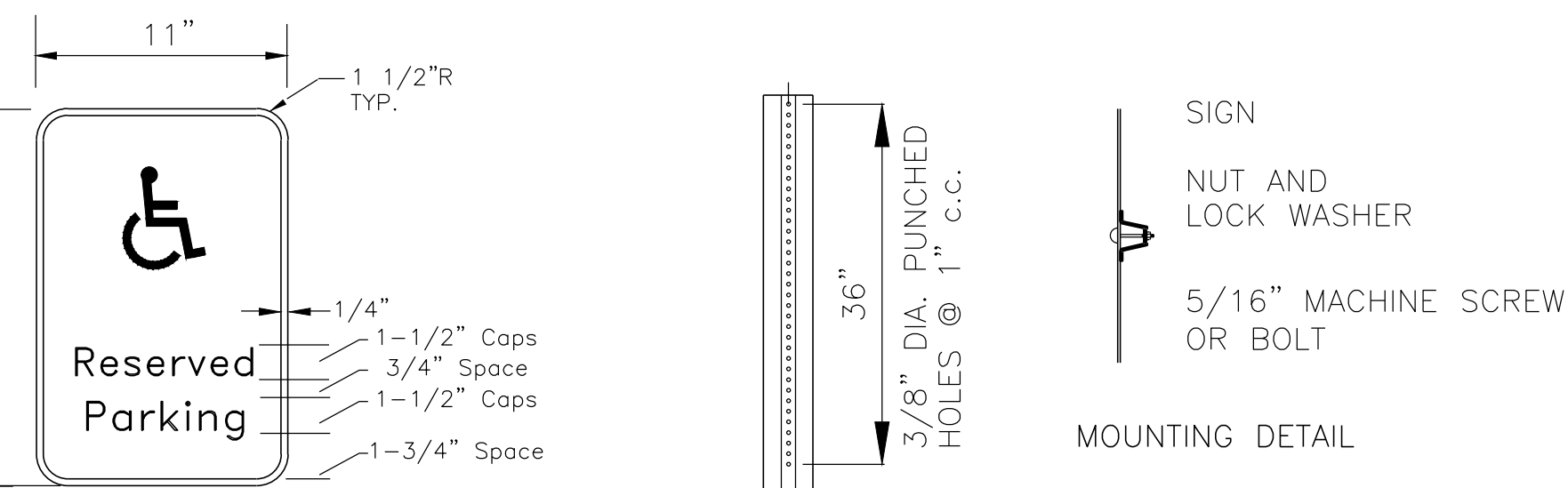

**HANDICAP SIGN & POST**

NOT TO SCALE

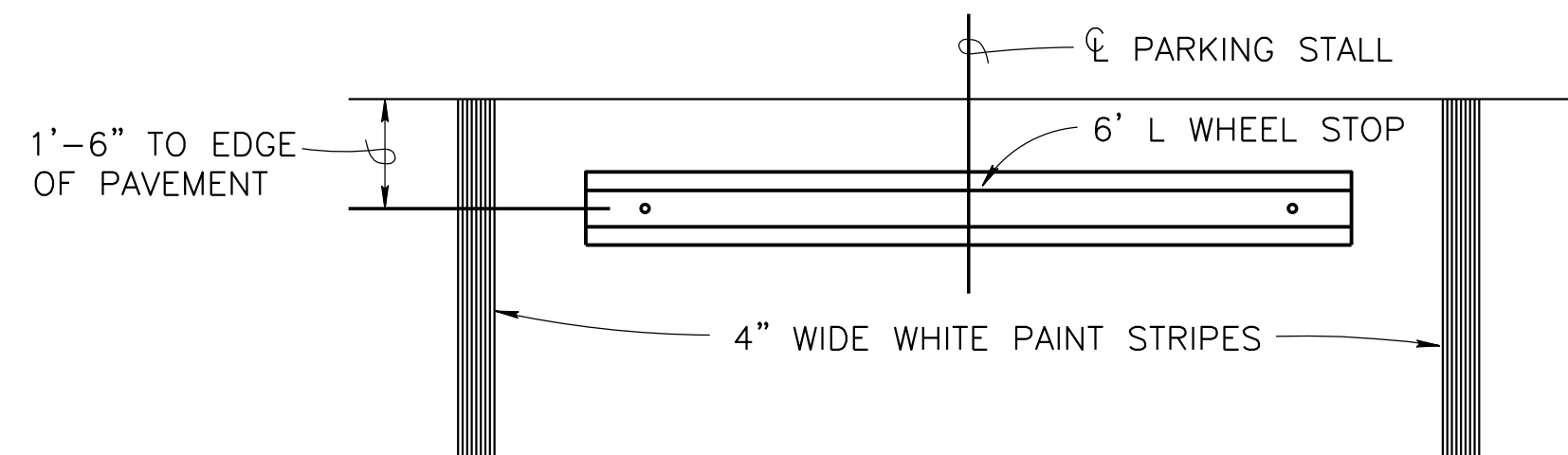

**RECYCLED RUBBER WHEEL STOP**

NOT TO SCALE

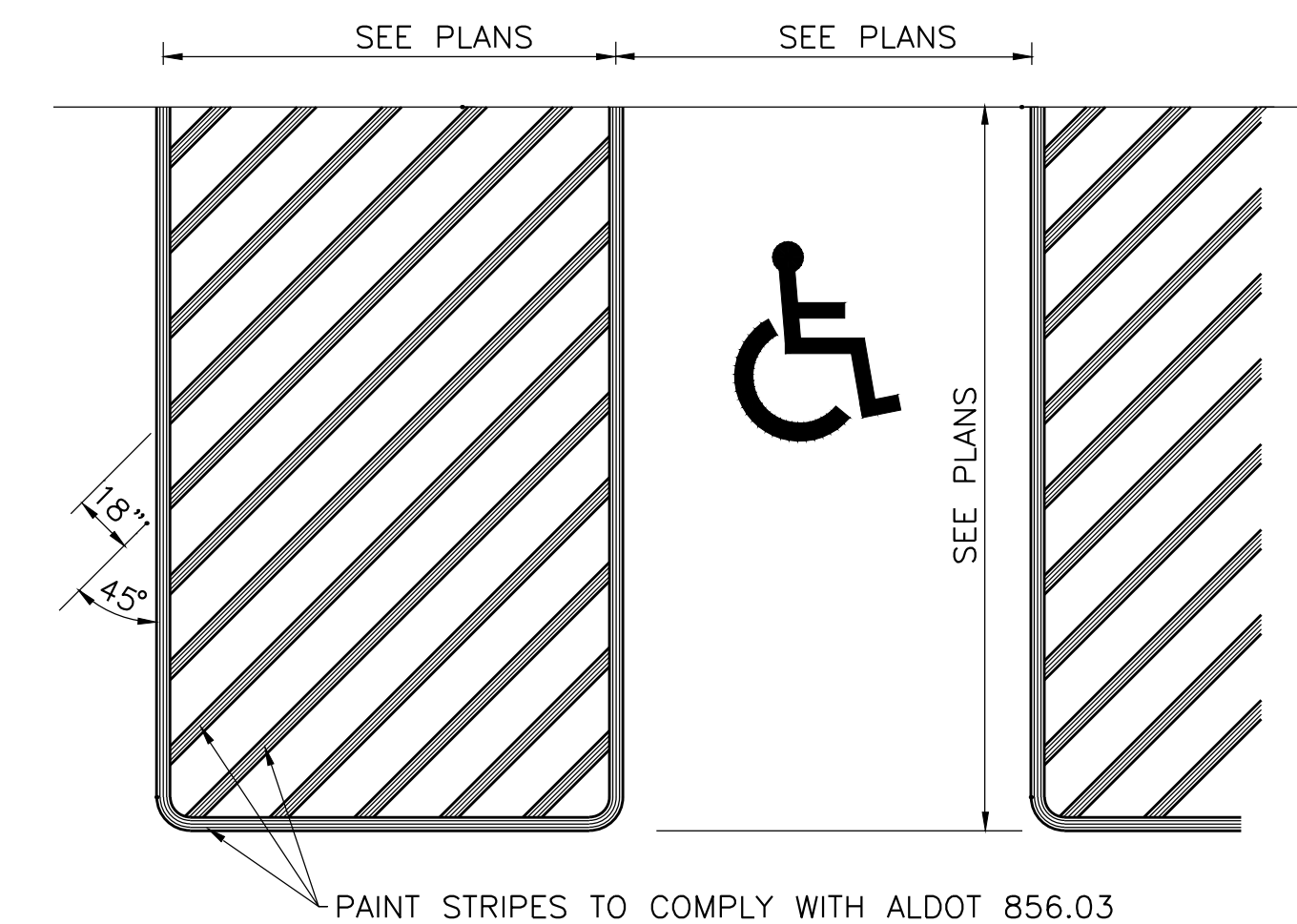

**HANDICAP ACCESS MARKING**

NOT TO SCALE



NOT TO SCALE

|  |                               |
|--|-------------------------------|
| DORSEY JOB NUMBER:<br>MOB-2024-03              | DESIGNED BY:<br>L. DORSEY, PE |
| ISSUE DATE:<br>11/1/2024                       | DRAWN BY:<br>DORSEY           |
| CAD FILE NAME:<br>C501-PinehillRecyclingCenter | CHECKED BY:<br>S. DORSEY      |
| REVISIONS/ISSUES:                              | DATE:                         |

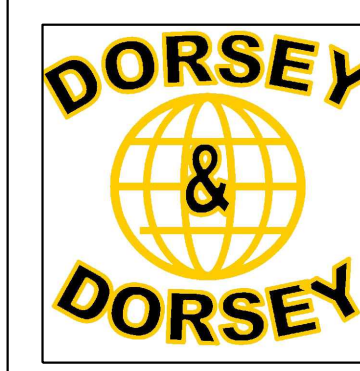
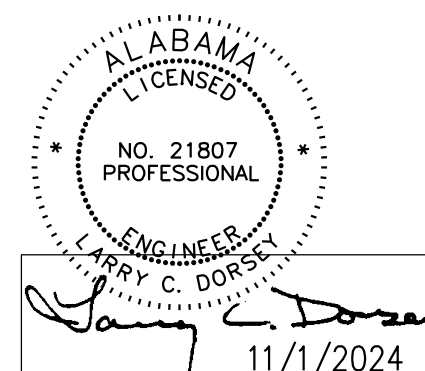

Integrity  
Quality  
Excellence

6051 AIRPORT BLVD., STE B3  
MOBILE, ALABAMA 36608  
p251.605.2023

**CITY PROJECT NO: PW-062-24**  
**PINEHILL RECYCLING CENTER**  
**NEW MODULAR BUILDING**

308 PINEHILL DRIVE  
CITY OF MOBILE, ALABAMA

SHEET DESCRIPTION & NUMBER:  
MISCELLANEOUS  
DETAILS

C501

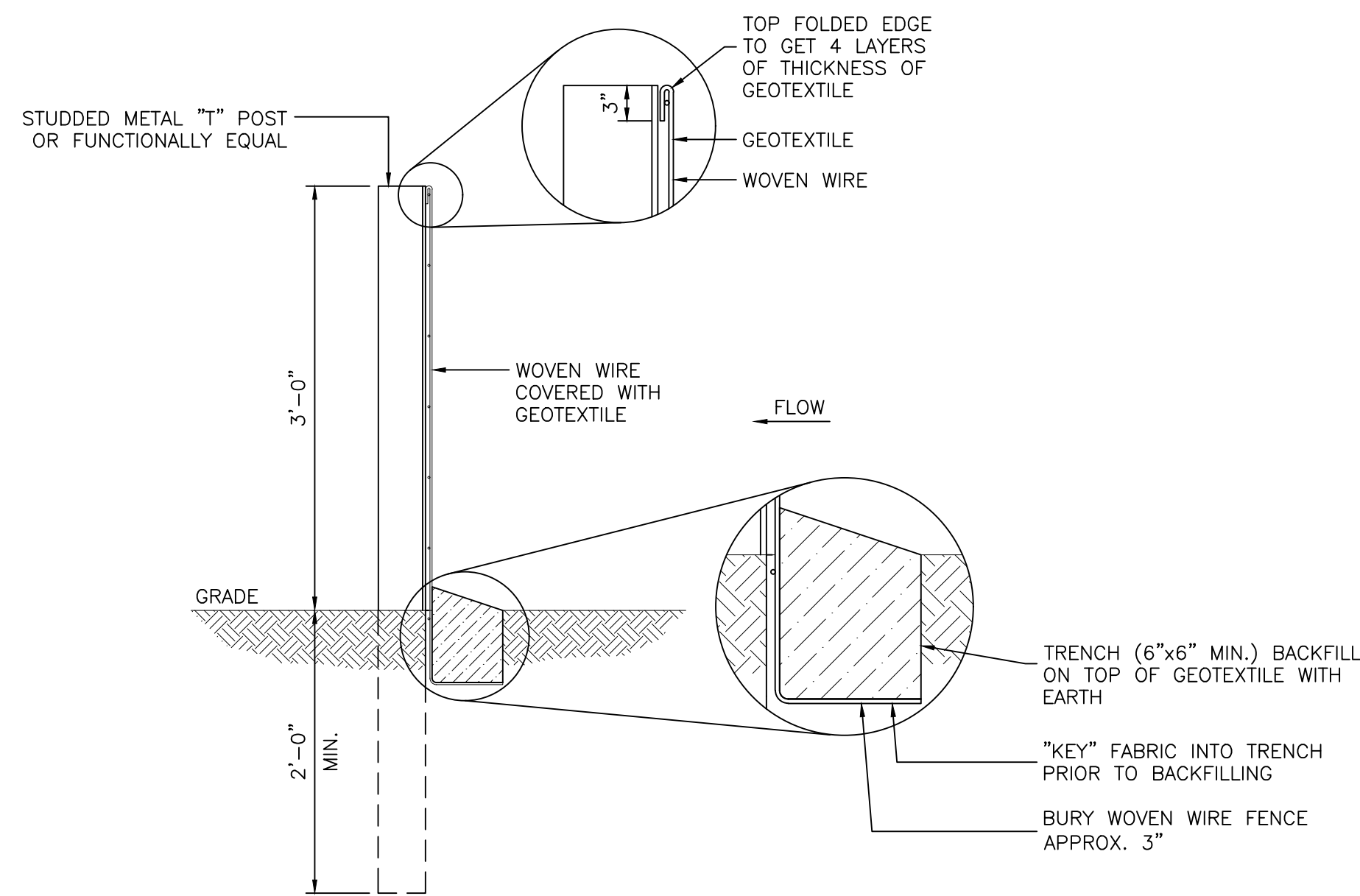

**SILT FENCE DETAIL**

NOT TO SCALE

**NOTES:**

(TYPE A) SILT FENCE SHALL BE USED IN AREAS WHERE FLOW IS NOT SEVERE OR AS DIRECTED BY THE ENGINEER.

SILT FENCES ARE TEMPORARY SEDIMENT CONTROL ITEMS THAT SHALL BE ERECTED OPPOSITE ERODIBLE AREAS SUCH AS NEWLY GRADED AREAS AND ADJACENT TO STREAMS, RIVERS, AND CHANNELS.

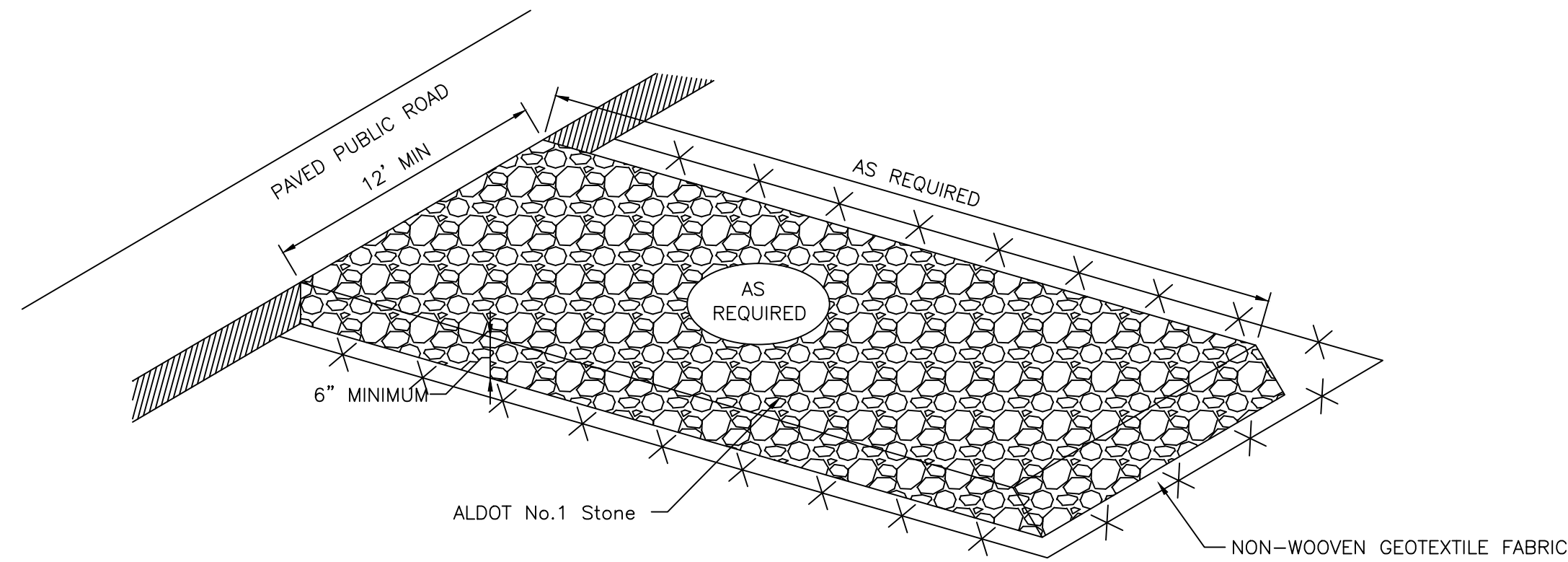

**CONSTRUCTION EXIT PAD**

NOT TO SCALE

**MAINTENANCE:**

THE CONSTRUCTION EXIT SHALL BE MAINTAINED IN SUCH A WAY TO PREVENT THE MOVEMENT OF MUD INTO PUBLIC TRAVEL WAYS. AGGREGATE SHOULD BE ADDED TO THE PAD WHENEVER IT WILL NOT SERVE AS AN ALL WEATHER TRAVEL WAY FOR THE CONSTRUCTION VEHICLES. CONSTRUCTION EXIT PROTECTIVE MEASURES SHALL BE USED AT ANY SITE EXIT LOCATION REQUIRED TO MEET THESE REQUIREMENTS.

A WASH STATION SHALL BE ADDED TO THE CONSTRUCTION EXIT PAD. THE CONTRACTOR IS RESPONSIBLE FOR ASSURANCE THAT ALL MUD IS WASHED OFF ALL EQUIPMENT BEFORE LEAVING THE SITE. DISCHARGES FROM THE WASH DOWN STATION SHALL BE FREE OF SEDIMENT AND NOT CAUSE ADVERSE TURBIDITY IMPACTS IN RECEIVING WATERS. THE CONTRACTOR IS RESPONSIBLE FOR SUITABLE POWER WASHING EQUIPMENT.

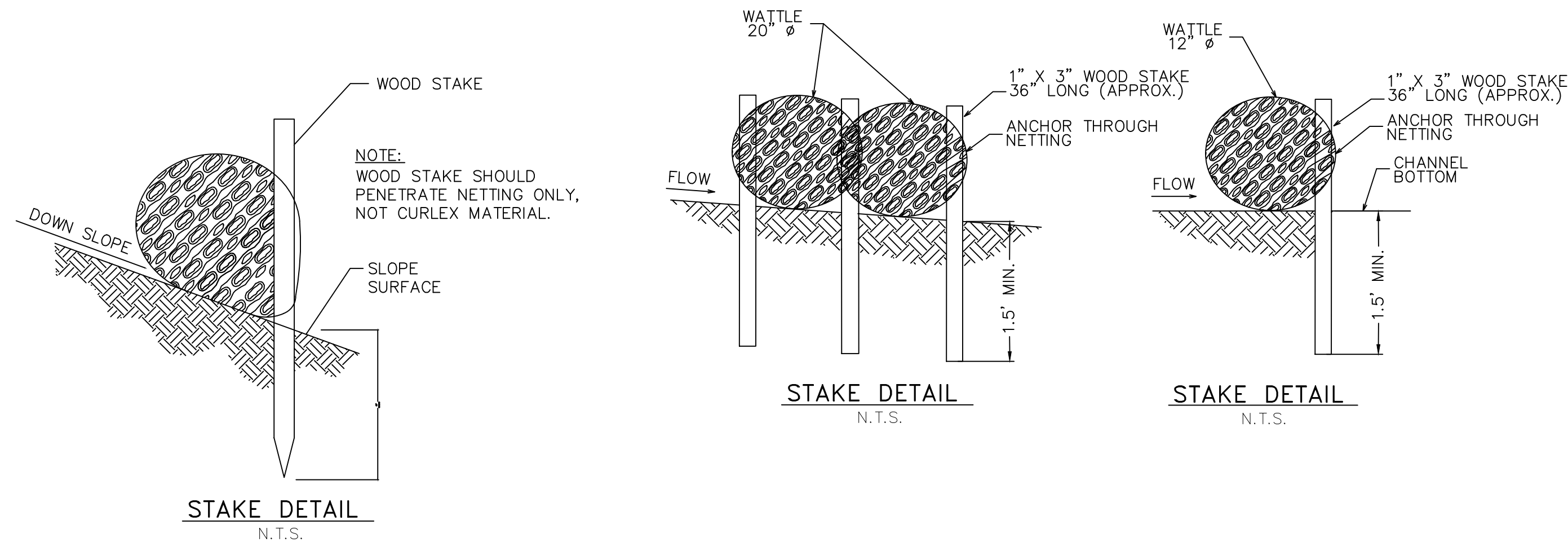

**EXCELSIOR WATTLE DETAILS**

NOT TO SCALE



GRAPHIC SCALE  
(NONE)

|  |                               |
|--|-------------------------------|
| DORSEY JOB NUMBER:<br>MOB-2024-03              | DESIGNED BY:<br>L. DORSEY, PE |
| ISSUE DATE:<br>11/1/2024                       | DRAWN BY:<br>DORSEY           |
| CAD FILE NAME:<br>C502-PinehillRecyclingCenter | CHECKED BY:<br>S. DORSEY      |
| REVISIONS/ISSUES:                              | DATE:                         |
|  |                               |
|  |                               |

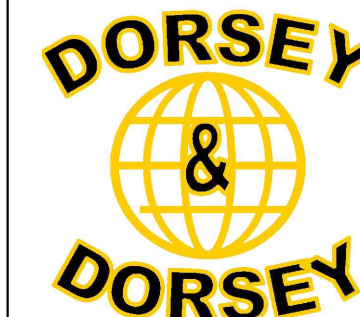
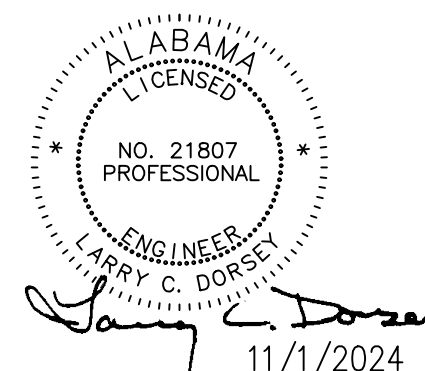

Integrity  
Quality  
Excellence

1114 WILDWOOD AVE  
MOBILE, ALABAMA 36609  
p251.605.2023

CITY PROJECT NO: PW-062-24  
**PINEHILL RECYCLING CENTER  
NEW MODULAR BUILDING**

308 PINEHILL DRIVE  
CITY OF MOBILE, ALABAMA

SHEET DESCRIPTION & NUMBER:  
ENVIRONMENTAL  
CONTROL  
PLAN & DETAILS

C502



**SUPPLEMENTAL GENERAL NOTES**

**EROSION AND SEDIMENT CONTROLS:**

**1. VEGETATIVE PRACTICES**

Such practices may include: temporary seeding, permanent seeding, mulching, mating, sod stabilization, vegetative buffer strips, phasing and protection of trees. the contractor shall initiate appropriate vegetative practices on all disturbed areas within seven (7) days if they are to remain dormant (undisturbed) for more than fifteen (15) days. permanent or temporary soil stabilization shall be applied to disturbed areas within seven (7) days after final grade is reached on any portion of the site.

**2. STRUCTURAL PRACTICES**

Structural practices shall be used to control erosion and trap sediment from all sites remaining disturbed for more than fourteen (14) days.

**3. TIMING**

Sediment control structures shall be functional throughout earth disturbing activity. Sediment basins and perimeter sediment barriers shall be implemented as the first step of grading and within seven (7) days from the start of grubbing. They shall continue to function until the upslope development area is re-stabilized.

**4. SEDIMENT BARRIERS**

Sheet flow runoff from denuded areas shall be intercepted by sediment barriers. sediment barriers, such as filter fabric fence (and wattles, or straw bails), shall protect adjacent lands and water resources from sediment transport bt sheet flow.

**5. WASTE DISPOSAL**

No solid or liquid waste, including building materials, shall be discharged into storm water runoff. Off-site vehicle tracking of sediments shall be minimized. The plan shall ensure and demonstrate compliance with applicable state or local waste disposal, sanitary sewer or septic system regulations.

**6. MAINTENANCE**

All temporary and permanent control practices shall be maintained and repaired as needed to assure continued performance of their intended function.

**VEGETATIVE PRACTICES:**

**1. PRESERVING EXISTING VEGETATION**

Wherever possible, preserve existing trees, shrubs and other vegetation. To prevent root damage, do not grade, place soil piles, or park vehicles near trees marked for preservation. Place plastic mesh fence barriers around trees to protect the area below their branches.

**2. REVEGETATION**

Seed, sod or mulch bare soil as soon as possible. If construction is completed after October 31, seeding or sodding may be delayed. Applying mulch or temporary seed (such as rye or winter wheat) is recommended if weather permits. Straw bale or silt fences must be maintained until final seeding or sodding is completed in spring March 1 - May 31.

**3. SEEDING AND MULCHING**

Spread 4 to 6 inches of topsoil. Fertilize according to the soil test or apply 2 lb./1000 sq.ft. of 18-24-6 fertilizer. Seed with an appropriate mix for the site (See Table 1). Rake lightly to cover seed with 1/4 inch of soil. Roll lightly. Mulch with straw (70-90 lb.) or one bale per 1000 sq. ft. Anchor mulch by punching 2 inches into the soil with a dull, weighted disk or by using netting or other measures on steep slopes or windy areas. water gently every day or two to keep soil moist. less watering is needed once grass is 2 inches tall.

**TYPICAL LAWN SEED MIXTURES**

| PERCENT BY WEIGHT               |     | FOR OVERALL SITE   |
|---------------------------------|-----|--------------------|
| GRASS                           |     |                    |
| COMMON BERMUDA GRASS            | 80% | (CYNODON DACTYLON) |
| ANNUAL RYEGRASS                 | 20% |                    |
| SEEDING RATE (LB./1000 SQ. FT.) | 3   |                    |

TABLE 1

**4. SODDING**

Spread 4 to 6 inches of topsoil. fertilize according to soil test or apply 2 lb./1000 sq. ft. of 18-24-6 fertilizer. lightly water soil lay sod. Tamp or roll lightly. On slopes, lay sod starting at the bottom and work toward the top. Peg each piece down in several places. Initial watering should wet soil 6 inches deep (or until water stands 1 inch deep in a straight sided container). Then water lightly every day or two for 2 weeks.

**SEDIMENT BARRIERS:**

**1. SOIL PILES**

Locate away from any downslope street, driveway, stream, lake, wetland, ditch or drainage way. Temporary seed such as annual rye is recommended for topsoil piles. surround with straw bales or silt fence.

**2. SILT FENCE (WATTLES OR STRAW BALES)**

Put up before any other work is done. Install on down slope side(s) of site with ends extended up side slopes a short distance. Place parallel to the contour of the land to allow water to pond before the fence. Entrench bales 4 inches deep. Stake with 2 stakes per bale or 1 stake every 3 feet for silt fence. Leave no gaps between bales or silt fence. Inspect and repair once a week and after every 1/2 inch of rain. Remove sediment if deposits reach half the fence or straw bale height. Maintain until a lawn is established.

**STORM DRAIN INLET PROTECTION:**

To prevent sediment from entering the storm discharge systems prior to permanent stabilization of the disturbed drainage area. Different types of structures are applicable to different conditions.

**1. PLANNING CONSIDERATIONS**

Storm sewers, which are made operational before their drainage area is stabilized, can convey large amounts of sediment to natural drainage ways. In case of extreme sediment loading, the storm sewer itself may clog and lose a major portion of its capacity. To avoid these problems, it is necessary to prevent sediment from entering the system at the inlets. This practice contains several types of inlet filters and traps which have different applications, dependent upon site conditions and type of inlet. Other innovative techniques for accomplishing the same purposes are encouraged, but only after careful study of their effectiveness should they be installed.

**2. DESIGN CRITERIA**

The inlet protection device shall be constructed in a manner that will facilitate cleanout and disposal of trapped sediment and minimize interference with construction activities. The inlet protection devices shall be constructed in such a manner that any resultant ponding of stormwater will not cause excessive inconvenience or damage to adjacent areas or structures. Design criteria, more specific to each particular inlet protection device, will be found with that construction specification.

**3. FABRIC DROP INLET PROTECTION -SEDIMENT FILTER**

Staked filter fabric shall be placed surrounding the inlet.the filter barrier shall be entrenched and backfilled. A narrow trench shall be excavated around the inlet to a minimum depth of 12". After the stakes are in place, backfilled and compacted against the filter barrier.

This method of inlet protection is applicable where the inlet drains a relatively flat area (slopes no greater than 5 percent) where sheet or overland flows (not exceeding 0.5 cfs) are typical.

Block and gravel inlet protection or filter fabric inlet protection devices, such as dandy curb sack or equal, are to be used on existing inlets along the driveway or roads.

**CONSTRUCTION BEST MANAGEMENT PRACTICES PLAN (CBMPP) NOTES**

**CONSTRUCTION PHASE REQUIREMENTS:**

1. GENERAL -During construction, the contractor shall be responsible for the implementation of the CBMPP in accordance with the requirements listed below.

2. POTENTIAL POLLUTANTS - The follow categories shall be considered potential pollutants if not controlled by the contractor.

2.1.CONSTRUCTION EQUIPMENT: Fuel, oil, antifreeze, grease, and brake fluid from internal combustion engine equipment; dust created by driving equipment across dry, dirty surfaces.

2.2.CONSTRUCTION MATERIALS: Siltation of soil resulting from earth moving, rainfall, or tracking by vehicles; waste created by cutting, sawing, and drilling operations.

2.3.CONSTRUCTION MATERIAL PACKAGING: Cardboard boxes, wood crates and pallets; cellophane used to wrap boxes on pallets; styrofoam and other materials used to cushion materials in boxes; bags used to hold small parts.

**3. STORMWATER QUALITY CONTIROL MEASURES FOR LAND DISTURBING ACTIVITIES.**

3.1.Provide and maintain access drive to the site.

3.2.Sediment control along down slope sides of construction site using silt fence or straw bales to control rain water sheet flow and siltation from construction site (see

construction plans).

3.3.Provide sediment control for concentrated flow areas barriers to slow down and filter siltation. the only concentrated flow areas anticipated for this site are around catch basins and drainage swales.

3.4. STORM SEWER INLET PROTECTION - All storm sewer inlets/catch basins shall be provided with filters around inlets to prevent silt from entering storm sewer system.

3.5.Runoff control measures - primarily the site drains by sheet flow to the northwest.

3.6.No grade stabilization structures are anticipated on this site.

3.7.All dimensions and specifications for stormwater quality measures are shown on this sheet or C501. Location of measures are shown on erosion control plan sheet and described by note.

3.8.Permanent and temporary surface stability shall be completed per notes and specifications on this sheet. Soil stockpile areas shall be temporarily stabilized and perimeter silt fence protection around the stock pile shall be installed and maintained.

3.9.Contractors shall establish a material handling and spill prevention plan. See plan guidelines below for additional information.

3.10.The stormwater pollution prevention measures shall be inspected weekly and following 1/2" rain event. All inspections must be documented. Documentation shall include name of individual doing inspection, date, and amount of last rainfall, practices inspected, practices maintained and/or repaired.

3.11. Contractor shall follow and adhere to erosion and sediment control notes and specifications shown in construction plans.

4. MATERIAL HANDLING AND SPILL PREVENTION PLAN - Contractor shall develop a plan to handle material and prevent spills on site during construction. All contractors on the site shall comply with the plan. Pollutants shall be previously described in paragraph 2.

4.1.CONSTRUCTION EQUIPMENT shall be fueled and serviced at one location on the site. This location shall be a hard surface or compacted stone. Spills shall be cleaned immediately by absorption of liquid with absorbent material. Remove and properly dispose all contaminated materials following a spill. All spills shall be immediately reported to construction manager. Equipment repairs shall be completed off-site at a facility suitable for containment of fluids. If repairs are necessary on-site, suitable impermeable ground cover and containers shall be used to prevent contamination of soil below. All potential pollutant containers shall be routinely inspected for leaks. If leaks are detected, containers shall be disposed of properly. All empty or unusable containers of possible pollutants shall be removed from the site and disposed of properly.

4.2.CONSTRUCTION MATERIALS - All erosion and sediment control measures as shown on the drawings shall be in place prior to disturbance of land adjacent to the control measure. Measures shall be maintained until final restoration is established. Any areas damaged shall be immediately repaired. Waste materials including cuttings, scraps, equipment and material packaging materials created at the site shall be immediately disposed of into acceptable and covered waste containers. Waste containers shall be emptied frequently so not to overfill causing waste materials to litter the site. Daily inspections of the site shall be completed to pick up and dispose of waste materials. Inspect stored material for loose packaging material. If found, re-fasten material or dispose of them properly.

**DUST CONTROL**

A water truck equipped with suitable sprinkling devices and street sweeping equipment shall be on-site during periods of dry weather for dust control. Water shall be applied at least 4 times a day to all unpaved surfaces during periods of dry weather to help control dust. Dust control evaluations shall be performed during representative, normal working conditions by the contractor. No evaluations shall be necessary if precipitation has occurred that is sufficient for dust control.

**CITY PROJECT NO: PW-062-24**

**PINEHILL RECYCLING CENTER  
NEW MODULAR BUILDING**

**308 PINEHILL DRIVE  
CITY OF MOBILE, ALABAMA**

SHEET DESCRIPTION & NUMBER:

**SUPPLEMENTAL  
ENVIRONMENTAL  
CONTROLS**

**C503**



GRAPHIC SCALE  
(NONE)

|  |                               |
|--|-------------------------------|
| DORSEY JOB NUMBER:<br>MOB-2024-03              | DESIGNED BY:<br>L. DORSEY, PE |
| ISSUE DATE:<br>11/1/2024                       | DRAWN BY:<br>DORSEY           |
| CAD FILE NAME:<br>C503-PinehillRecyclingCenter | CHECKED BY:<br>S. DORSEY      |
| REVISIONS/ISSUES:                              | DATE:                         |
|  |                               |
|  |                               |

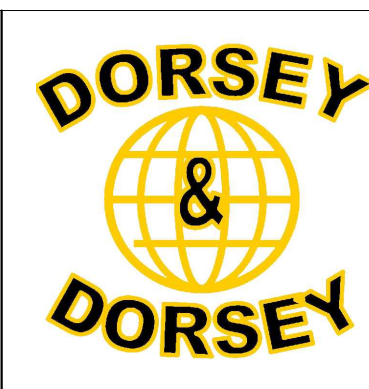
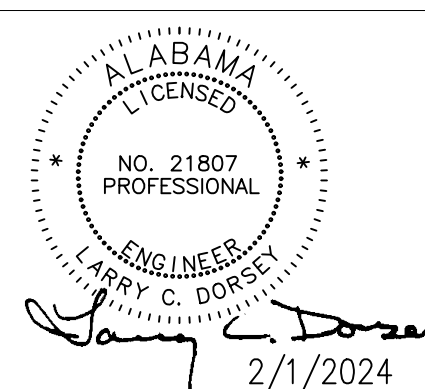

Integrity  
Quality  
Excellence

1114 WILDWOOD AVE  
MOBILE, ALABAMA 36609  
p251.605.2023